

autolamps

Product Index

Pages

Cable systems	10-13
Marker lamps.....	15-31
Marker lamps with white surround	32-33
Marker lamps with chrome surround	34-39
Marker lamps with chrome surround/clear lens	40-47
Licence plate lamps	48-51
Single function lamps.....	52-83
Single function lamps with chrome surround	84-93
Single function lamps with clear lens	94-96
Single function with chrome surround/clear lens	97-101
Combination lamps.....	102-145
Combination with chrome surround	146-155
Combination with chrome surround/clear lens	156-159
Front indicator lamps	160-161
Front indicator/daytime running lamps	162
Side Indicator lamps.....	163
Hazard warning lamps	164-167
Hazard warning beacons.....	168-173
Hazard warning arrow boards.....	174-175
Work lamps.....	176-184
Driving lamps.....	184
Light bars	185-190
Hand held work lamps	191
Marine lamps.....	192-199
Interior lamps	200-207
Exterior lamps.....	208-213
Coloured lamps	214-219
Reflectors	220-221
Can bus and flasher solutions	222-225

DISCLAIMER

LED Technologies Pty. Ltd. have made every effort to ensure that the information contained in this catalogue is correct and accurate; current information should be checked at the time of placing an order and before any manufacturing/installation is to be commenced. Measurements provided are accurate at the time of publication; we advise measurements should be confirmed before final decisions/installations are made. LED Technologies Pty. Ltd. reserves the right to improve, modify, make dimensional design and technical changes or discontinue or update designs without prior notice; although we will take all measures to inform our customers if and when possible of any changes made. LED Technologies Pty. Ltd. will not accept liability of any kind due to misuse or abuse of any products not used as intended. Date of Printing June 2014

LED Technologies Pty Ltd

ISO 9001:2008 accredited

We believe in combining functional innovation, long lasting quality and value for money in everything we produce, to benefit all who are in contact with our company or products. We believe that local ideas should be encouraged and protected in order to drive a competitive local market that is rich and dynamic to consistently provide the consumer with superior choices and strengthen the reputation of Australian design on a global scale.

LED Autolamps is an Australian company with global vision that pushes the boundaries of LED technologies to successfully compete with industry giants from around the world. We design, manufacture and guarantee high quality LED auto lamps at a competitive price for all sectors of the automotive lighting industry.

We are directly involved with our LED products at every stage of their development to ensure there is no compromise on quality or service alongside the ability to adapt our designs to suit specific client needs. We actively defend our products and designs against low quality imitations to safeguard our integrity and that of the Australian automotive industry and proudly distribute our Australian designed products throughout Europe.

The quality and innovative features of our LED products are tested and trusted by Australian manufacturing companies that incorporate our LED brand into their product designs. Our clients put our auto lights through some of the toughest conditions before they are used to ensure that their own customers are receiving the best product on the market that will not fail.

LED Autolamps offer guarantees on their products in excess of the market and are the only company in Australia to offer LED auto lamp products with a lifetime guarantee. To date LED Autolamps have registered over 25 patented and designs that have been successfully used in the market place and are the only Australian company that derives its income solely from LED products.

Tony Ottobre
Managing Director
LED Technologies Pty Ltd



At LED Autolamps we believe in providing products that have the customer's needs at the core of their design. We take pride in being industry innovators and hold the delivery of the best LED products on the market as our utmost importance. Every step of the process is carefully monitored by our manufacturing teams in Australia and Taiwan for quality assurance at every stage of development.

Corporate Office

Our contemporary Head Office is located in Bundoora, Victoria where our customers enjoy a professional and welcoming environment as their needs are met by our friendly staff. Our purpose built, modern office makes a statement to all visitors about how we approach both our customers and our customer service.



Warehousing

Our 1473sq metre warehouse facility is constantly in motion regularly welcoming new products and designs. As part of our ISO9001 accreditation our trained staff are guided by procedures that ensure a smooth and efficient path from customer order through to delivery. With thousands of parts passing through despatch every day, the high level of accuracy in this department is an integral part of our excellence in customer service.



Branding and Merchandising

The LED Autolamps brand is one we are proud of and is designed to stand out in a crowded and sometimes confusing marketplace. We are confident it builds the reputation of our reseller, repairer and manufacturing customers. To complement the brand, our Merchandise stands are visually appealing and are configured to engage your customers at the point of sale.



R&D and Manufacturing

Our investment in R&D and manufacturing facilities is testament to our promise of quality. It ensures that we are consistently providing innovative and affordable high quality LED lighting products with warranties that lead the market for customer satisfaction.



LED Autolamps wide range of products

A
D
R

Marker lamps 10 to choose from



T
R
A
I
L
E
R

20 to choose from



S
M
A
L
L

8 to choose from



M
E
D
I
U
M

9 to choose from



L
A
R
G
E

6 to choose from



LED Autolamps range of family products

At LED Autolamps we understand that the Automotive market can demand a wide variety of lamps in all shapes and sizes. To meet this demand we design and manufacture many of our lamps in a range of sizes. The benefit of this is that you can choose the style of lamp regardless of the size of your vehicle. For a fleet it means that you can have a uniform look to all the vehicles in your fleet. This is unique to LED Autolamps.

200 Series lamps available in small, medium and large

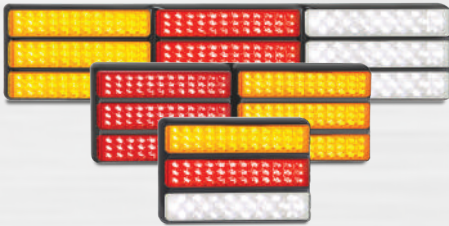

Square Series available in small, medium and large

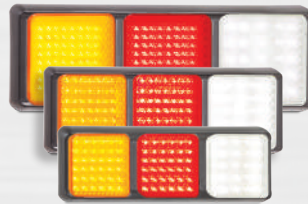

Maxilamp Series available in small, medium and large



Maxilamp Black Chrome Series available in small, medium and large



Eurolamps available in small, medium and large

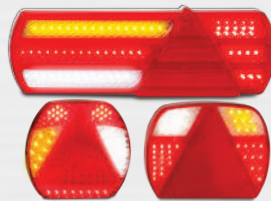

Jumbo Series available in small, medium and large



200 Series available in small and medium

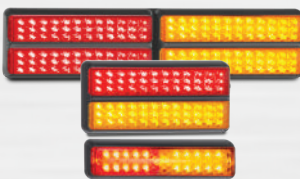

Square Series Single available in small, medium and large



Diamond lens pattern available in small and medium



Slimline interior lamp series



Light bars available in different sizes



Slimline single lamps small, medium and large



The biggest range of LED lighting in Australia with over 500 products



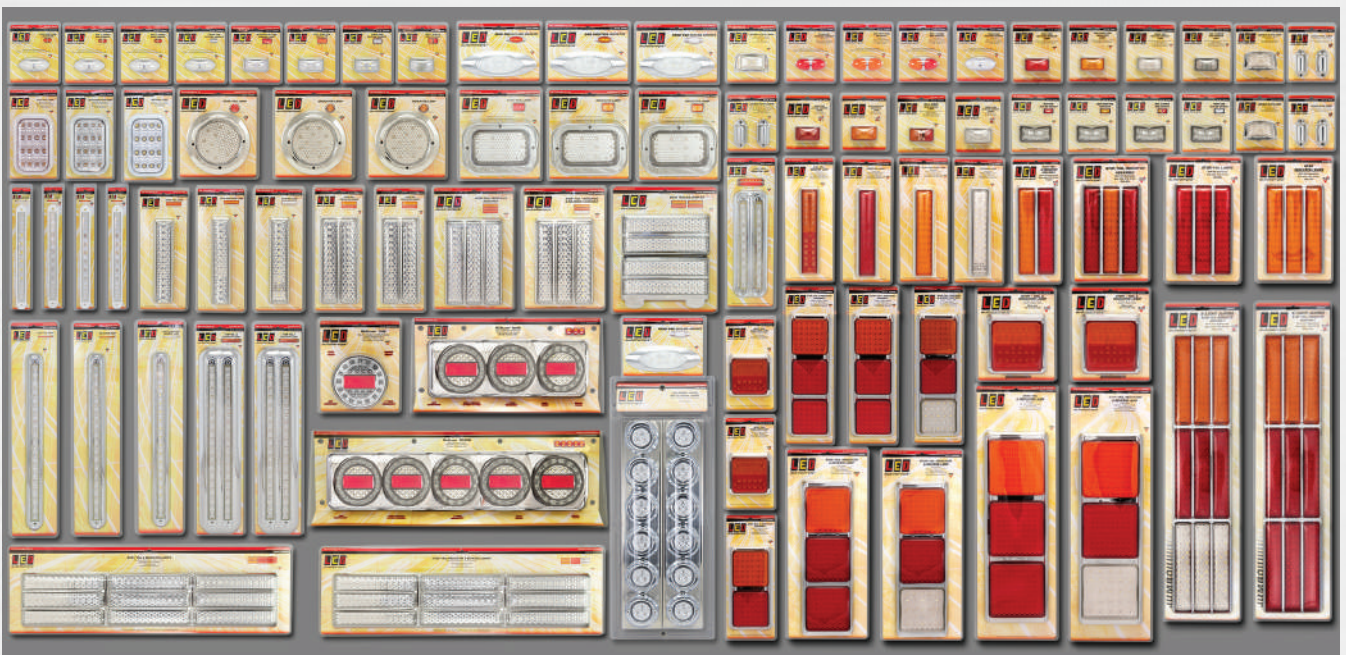
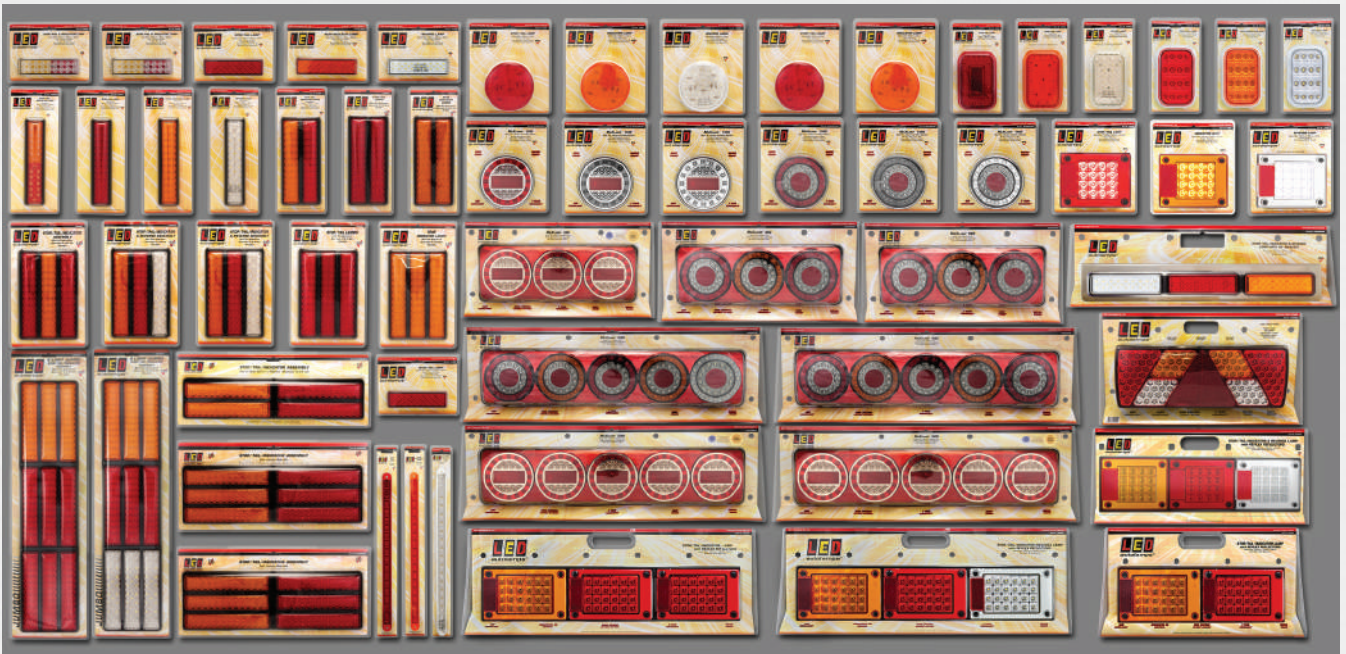
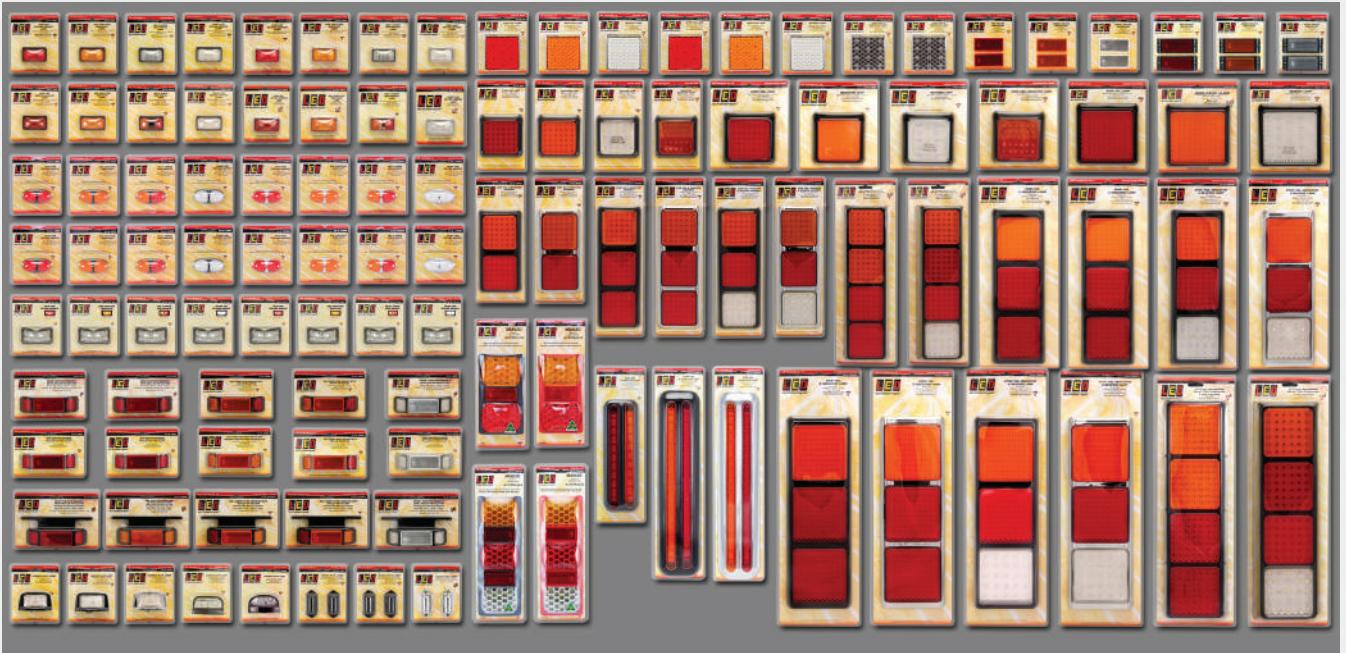



Cable system for trailers complete with tinned copper wiring

- 100% waterproof
- Specially designed plugs
- No assembly tools required



Wiring of a trailer can now be done quickly and easily without cutting, splicing, joining or insulating wires & cables. The cables and plugs are specially designed with tinned copper terminals and water proof grease with IP67 rated plugs and sockets ensuring a water tight connection. All main cables have accessory wires at the ends of the male plugs which are compatible with the marker lamp plug in cable system. Cabling system comprises of the following:

- 1. Gooseneck to lamp** - this cable is fitted from the front of the trailers frame to the rear right hand lamp. The male plug to the lamp has two accessory wires for side markers.
- 2. Lamp to lamp** - this cable is fitted from the right hand lamp to the left hand lamp. The male plug to the lamp has two accessory wires for side markers.
- 3. Boat trailer cable** - this cable connects each Individual lamp to the gooseneck area and plugs into the boat cable joiner. The male plug to the lamp has two accessory wires for side markers.
- 4. Boat cable connector** - this three way connector joins the left and right boat trailer cables to the cable with the trailer plug.
- 5. Cable with trailer plug** - this 1 metre cable is fitted to the gooseneck to lamp cable, or the boat cable connector. This cable ends with a trailer plug. (7 pin flat, 7 pin round or 7 pin small round).
- 6. Marker lamp cable and connector** - For fitting marker lamps to the trailer. (See Large Trailer opposite for description)
- 7. Licence lamp cable and connector** - LP1 and 35BLM1P have a 1 metre cable with a plug that fits into the back of the 100, 150 and 275 series lamps. Also available with plug is the LP100 and LP150 licence plate frames which fit to the back of the 100 and 150 series lamps. The 200 and 207 series lamps have the licence plate lamp incorporated in its bracket.

Cable system for trailers from 3.7 meters to 12 meters

Lamp to gooseneck cable

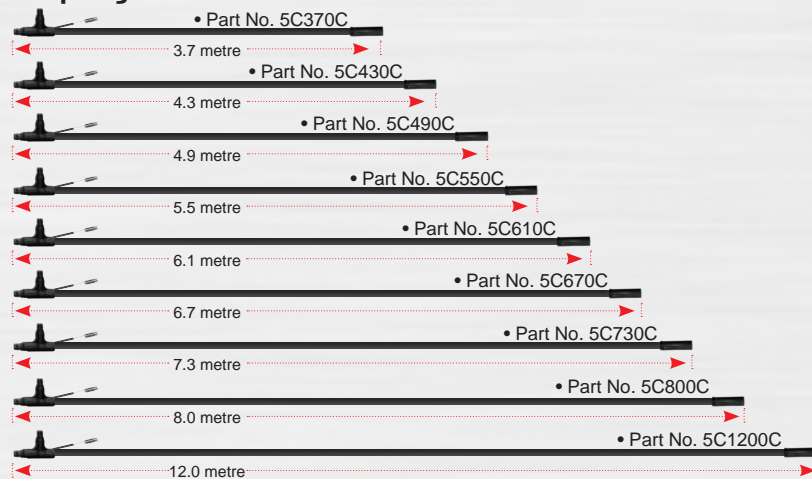

Lamp to lamp cable

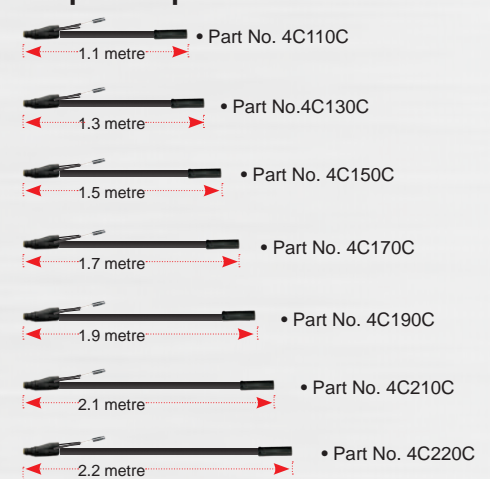

Gooseneck to car with trailer plug

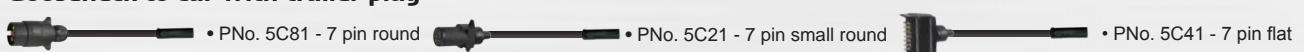

Cable system for boat trailers from 4.0 meters to 12 meters

Boat trailer cable

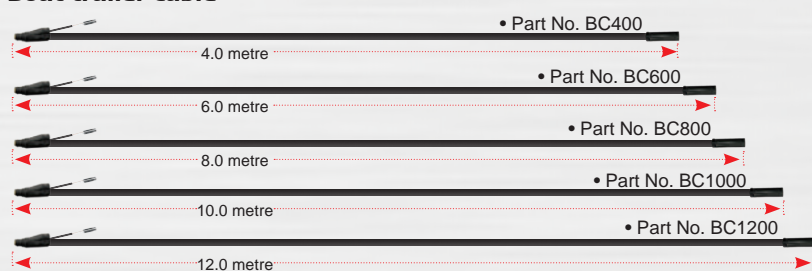

Joiner for left/right cable at gooseneck

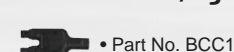

Gooseneck to car with trailer plug

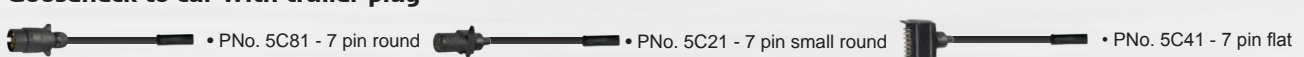

Cable system for trailers complete with tinned copper wiring

- 100% waterproof
- Specially designed plugs
- No assembly tools required

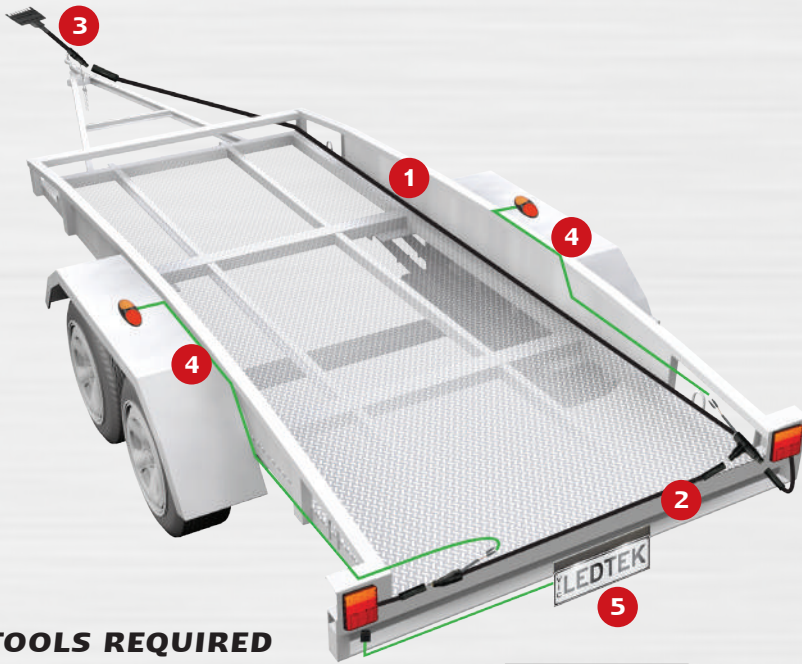

- 1 Gooseneck to lamp cable (5C)
- 2 Lamp to lamp
- 3 Cable with trailer plug
- 4 Marker lamp cable and connector
- 5 Licence lamp cable and connector

NO TOOLS REQUIRED
NO CUTTING
NO SPLICING
NO SOLDERING
NO JOINERS
NO TAPE

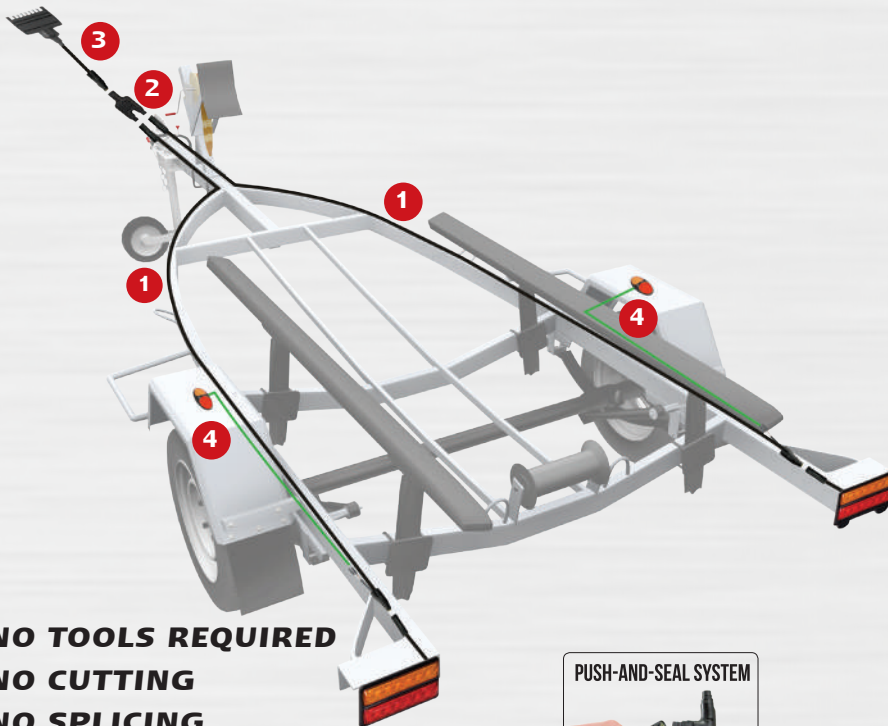

- 1 Boat trailer cable (5C)
- 2 Boat cable connector (2C)
- 3 Cable with trailer plug
- 4 Marker lamp cable and connector
- 5 Licence lamp cable and connector

NO TOOLS REQUIRED
NO CUTTING
NO SPLICING
NO SOLDERING
NO JOINERS
NO TAPE

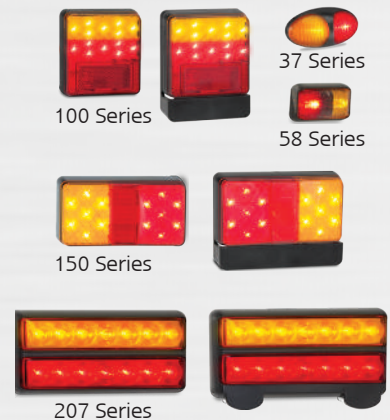

Heavy duty cable system for trucks and trailers up to 15m

- 100% waterproof
- Specially designed plugs
- No assembly tools required



The harness system offers a quick method of wiring a trailer without the need for any special tools. It comes with a choice of standard cable lengths from 60m to 15m and incorporates several new specially designed patented push-and-seal connectors which are rated to IP67 international protection standards. The push-and-seal plugs have been specially designed to be used on hard working vehicles and to be simply and easily installed and provide a 'cost effective' long life lighting harness solution that is extremely tough and durable. Also offered is a range of LED rear combination lamps.

Heavy duty cable system

Rear lamp cables with marker cables and plugs. These cables can be fitted to our lamps at our factory in Taiwan.

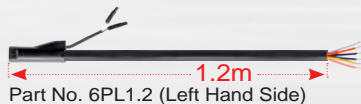

Part No. 6PL1.2 (Left Hand Side)

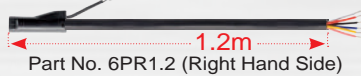

Part No. 6PR1.2 (Right Hand Side)

T piece connector



Part No. 8PTP (8 in 6 out)



Chassis cables - front of trailer to the T piece.



1 Main chassis cable T Piece connector incorporating a PCB board and 8 & 6 pin plugs.



2 Left and right rear lamp plug integrating twin core marker cable with plug connectors.



3 Main chassis cable with moulded 8 pin male connector.

Unique marker cable system

Heavy duty marker lamp cables

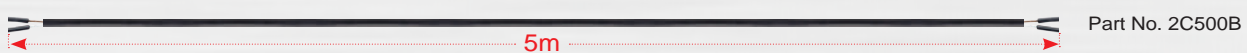
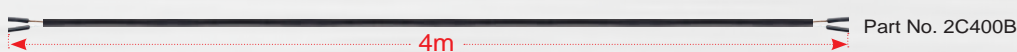
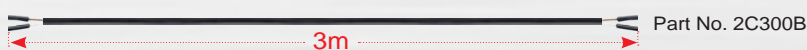

T piece connector



Marker cable covers



4 T Piece which incorporates a moulded round and square plug connectors for ease of assembly.



5 Twin core marker lamp T Piece showing ease of assembly



6 T Piece and twin core cable shown assembled with T Piece protective cover.

Heavy duty cable system for trucks and trailers up to 15m

- 100% waterproof
- Specially designed plugs
- No assembly tools required

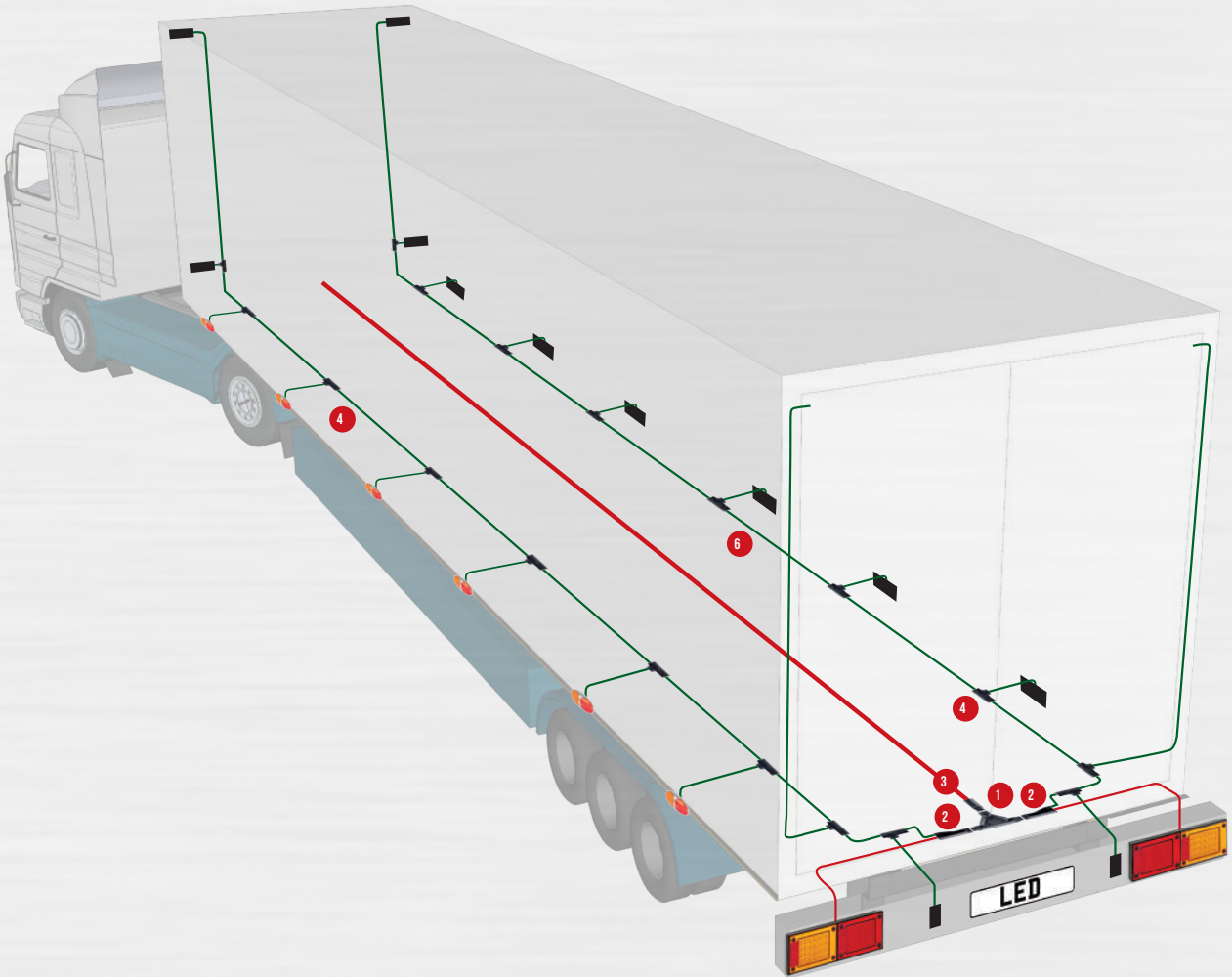

Chassis cables (8 Core)

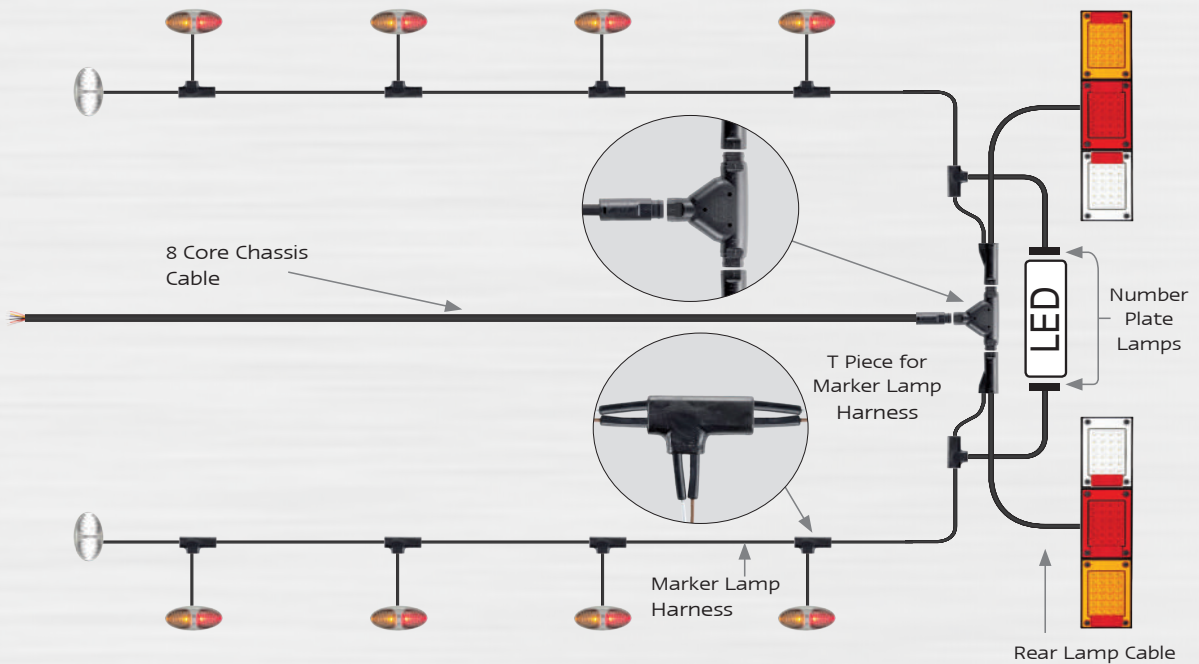

Introducing the new 37 Series Marker Lamps

Go to youtube and type in ledautolamps in the search bar

Dear Customer,

On the opposite page you will see a very new design marker lamp based on the most popular size being 70mm long, 35mm wide and 20mm depth.

The overall design has been based on an oval shape with rounded corners and without any edges. This allows for any foreign matter or debris to roll off rather than damage the lamp.

The visual appearance of this lamp is a personal choice; however, when fitted to a trailer it does give that sense of a modern appeal with a style all of its own.

The fitment of this lamp is totally new to the industry with an emphasis based on ease and speed.

What have we done to achieve this?

No screws or rivets to fasten this lamp.

In its place we have combined two types of fastening methods.

1/ Serrated plug, plastic injected into the base. The size of this plug is 6.1mm outer round diameter which when pushed into a 6mm round hole provides a tight secure fitment.

2/ 3M double sided tape shaped in the rear of the lamp with easy peel off protective cover. We consider 3M the best adhesive tape manufacturer in the world.

LED Autolamps guarantee this fitting for life, for an animated video of this product go to youtube and type in ledautolamps in the search bar.

LED Autolamps also have a harness system for this lamp using our IP67 waterproof rated round and square plug design. Now you can fit and wire up any amount of markers without ever using any tools. We deliver on our promise – ease and speed – saving you thousands per year on your labour costs.

37 Series Marker Lamps

- Easy to fit - No tools required
- Serrated plug and 3M tape
- 5 Year warranty



Part Number

- 37RM2P** - Multivolt 12-24V, Blister single
- 37RMB2P** - Multivolt 12-24V, Bulk poly bag
- 37RM3** - Multivolt 12-24V, 3m Cable, Bulk poly bag

Function Rear end outline marker
Size 70mm x 35mm x 20mm
Voltage Multivolt 12-24V
LED Qty 2
Cable 10cm with specially designed plugs or 3 meter cable

Draw @13.8V @28V
 0.04A 0.04A

Approvals **Function** **Category** **CRN**
ECE Rear end 02R1 6917



Part Number

- 37AM2P** - Multivolt 12-24V, Blister single
- 37AMB2P** - Multivolt 12-24V, Bulk poly bag
- 37AM3** - Multivolt 12-24V, 3m Cable, Bulk poly bag

Function Side marker
Size 70mm x 35mm x 20mm
Voltage Multivolt 12-24V
LED Qty 2
Cable 10cm with specially designed plugs or 3 meter cable

Draw @13.8V @28V
 0.04A 0.04A

Approvals **Function** **Category** **CRN**
ECE Marker 00SM1 1017



Part Number

- 37ARM2P** - Multivolt 12-24V, Blister single
- 37ARMB2P** - Multivolt 12-24V, Bulk poly bag
- 37ARM3** - Multivolt 12-24V, 3m Cable, Bulk poly bag

Function Side marker
Size 70mm x 35mm x 20mm
Voltage Multivolt 12-24V
LED Qty 2
Cable 10cm with specially designed plugs or 3 meter cable

Draw @13.8V @28V
 0.04A 0.04A

Approvals **Function** **Category** **CRN**
ADR Side 45/01 43515



Part Number

- 37WM2P** - Multivolt 12-24V, Blister single
- 37WMB2P** - Multivolt 12-24V, Bulk poly bag
- 37WM3** - Multivolt 12-24V, 3m Cable, Bulk poly bag

Function Front end outline marker
Size 70mm x 35mm x 20mm
Voltage Multivolt 12-24V
LED Qty 2
Cable 10cm with specially designed plugs or 3 meter cable

Draw @13.8V @28V
 0.04A 0.04A

Approvals **Function** **Category** **CRN**
ECE Front 02A 6918

Fitting Instructions

Drill two 6mm holes for serrated plugs and one 8mm hole or larger for the cable. Remove the 3M protective film from the back of the lamp and simply push into place. Please refer to ADR 13/00 for mounting instructions.



Technical Drawings

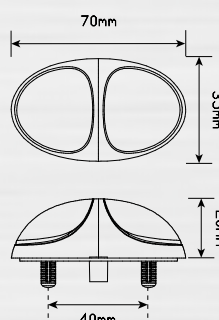

Blister Packaging



35 Series Marker Lamps

- Premium original design
- Low profile
- 5 Year warranty



Part Number

- 35RM** - Multivolt 12-24V, Blister single
- 35RMB** - Multivolt 12-24V, Bulk poly bag
- 35RM2** - Multivolt 12-24V, 2m Cable, Bulk poly bag

Function Rear end outline marker
Size 58mm x 35mm x 21mm
Voltage Multivolt 12-24V
LED Qty 4
Cable 40cm cable or
 2 metre cable

Draw @13.8V @28V
 0.12A 0.07A

Approvals **Function** **Category** **CRN**
ADR Rear end 49/00 34007



Part Number

- 35AM** - Multivolt 12-24V, Blister single
- 35AMB** - Multivolt 12-24V, Bulk poly bag
- 35AM2** - Multivolt 12-24V, 2m Cable, Bulk poly bag

Function Side direction indicator
Size 58mm x 35mm x 21mm
Voltage Multivolt 12-24V
LED Qty 4
Cable 40cm cable or
 2 metre cable

Draw @13.8V @28V
 0.10A 0.07A

Approvals **Function** **Category** **CRN**
ADR Indicator 6/00/5 33894



Part Number

- 35ARM** - Multivolt 12-24V, Blister single
- 35ARMB** - Multivolt 12-24V, Bulk poly bag
- 35ARM2** - Multivolt 12-24V, 2m Cable, Bulk poly bag

Function Side marker
Size 58mm x 35mm x 21mm
Voltage Multivolt 12-24V
LED Qty 4
Cable 40cm cable or
 2 metre cable

Draw @13.8V @28V
 0.10A 0.07A

Approvals **Function** **Category** **CRN**
ADR Side 45/01 34099



Part Number

- 35WM** - Multivolt 12-24V, Blister single
- 35WMB** - Multivolt 12-24V, Bulk poly bag
- 35WM2** - Multivolt 12-24V, 2m Cable, Bulk poly bag

Function Front end outline marker
Size 58mm x 35mm x 21mm
Voltage Multivolt 12-24V
LED Qty 4
Cable 40cm cable or
 2 metre cable

Draw @13.8V @28V
 0.05A 0.04A

Approvals **Function** **Category** **CRN**
ADR Front 49/00 34008

Fitting Instructions

Horizontally mount bracket onto flat surface with screws provided, run wires through back and clip lens into place. Please refer to ADR 13/00 for mounting instructions.

Technical Drawings

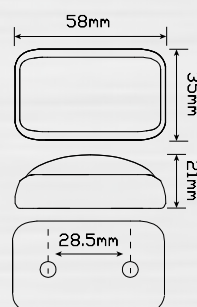

Blister Packaging



58 Series Marker Lamps

- New lens design
- Low profile
- 5 Year warranty



Part Number

- 58RM** - Multivolt 12-24V, Blister single
- 58RM10B** - Multivolt 12-24V, Bulk boxed 10 pack
- 58RM3** - Multivolt 12-24V, 3m Cable, Bulk poly bag
- 58RMB2P** - Multivolt 12-24V, Bulk poly bag with 2C plugs

Function Rear end outline marker
Size 58mm x 35mm x 21mm
Voltage Multivolt 12-24V
LED Qty 2
Cable 40cm cable or 10cm with plugs or 3 meter cable

Draw @13.8V @28V
 0.12A 0.04A

Approvals **Function** **Category** **CRN**
ADR Rear end 49/00 36840



Part Number

- 58AM** - Multivolt 12-24V, Blister single
- 58AM10B** - Multivolt 12-24V, Bulk boxed 10 pack
- 58AM3** - Multivolt 12-24V, 3m Cable, Bulk poly bag
- 58AMB2P** - Multivolt 12-24V, Bulk poly bag with 2C plugs

Function Side direction indicator
Size 58mm x 35mm x 21mm
Voltage Multivolt 12-24V
LED Qty 3
Cable 40cm cable or 10cm with plugs or 3 meter cable

Draw @13.8V @28V
 0.10A 0.04A

Approvals **Function** **Category** **CRN**
ADR Indicator 6/00 38277



Part Number

- 58ARM** - Multivolt 12-24V, Blister single
- 58ARM10B** - Multivolt 12-24V, Bulk boxed 10 pack
- 58ARM3** - Multivolt 12-24V, 3m Cable, Bulk poly bag
- 58ARMB2P** - Multivolt 12-24V, Bulk poly bag with 2C plugs

Function Side marker
Size 58mm x 35mm x 21mm
Voltage Multivolt 12-24V
LED Qty 2
Cable 40cm cable or 10cm with plugs or 3 meter cable

Draw @13.8V @28V
 0.10A 0.040A

Approvals **Function** **Category** **CRN**
ADR Side 45/01 36841



Part Number

- 58WM** - Multivolt 12-24V, Blister single
- 58WM10B** - Multivolt 12-24V, Bulk boxed 10 pack
- 58WM3** - Multivolt 12-24V, 3m Cable, Bulk poly bag
- 58WMB2P** - Multivolt 12-24V, Bulk poly bag with 2C plugs

Function Front end outline marker
Size 58mm x 35mm x 21mm
Voltage Multivolt 12-24V
LED Qty 2
Cable 40cm cable or 10cm with plugs or 3 meter cable

Draw @13.8V @28V
 0.05A 0.03A

Approvals **Function** **Category** **CRN**
ADR Front 49/00 36842

Fitting Instructions

Horizontally mount bracket onto flat surface with screws provided, run wires through back and clip lens into place. Please refer to ADR 13/00 for mounting instructions.

Technical Drawings

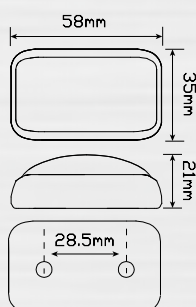

Blister Packaging



42 Series Marker Lamps

- Clear lens design
- Chunky bulky old style
- 5 Year warranty



Part Number
42RM - Multivolt 12-24V, Blister single
42RM10B - Multivolt 12-24V, Bulk boxed 10 pack

Function Rear end outline marker
Size 74mm x 38mm x 35mm
Voltage Multivolt 12-24V
LED Qty 2
Cable 16cm cable

Draw @13.8V @28V
 0.05A 0.06A

Approvals **Function** **Category** **CRN**
ADR Rear end 49/00 42839



Part Number
42AM - Multivolt 12-24V, Blister single
42AM10B - Multivolt 12-24V, Bulk boxed 10 pack

Function Side direction indicator
Size 74mm x 38mm x 35mm
Voltage Multivolt 12-24V
LED Qty 3
Cable 16cm cable

Draw @13.8V @28V
 0.05A 0.06A

Approvals **Function** **Category** **CRN**
ADR Indicator 6/00 42836



Part Number
42ARM - Multivolt 12-24V, Blister single
42ARM10B - Multivolt 12-24V, Bulk boxed 10 pack

Function Side marker
Size 74mm x 38mm x 35mm
Voltage Multivolt 12-24V
LED Qty 2
Cable 16cm cable

Draw @13.8V @28V
 0.05A 0.06A

Approvals **Function** **Category** **CRN**
ADR Side 45/01 42837



Part Number
42WM - Multivolt 12-24V, Blister single
42WM10B - Multivolt 12-24V, Bulk boxed 10 pack

Function Front end outline marker
Size 74mm x 38mm x 35mm
Voltage Multivolt 12-24V
LED Qty 2
Cable 16cm cable

Draw @13.8V @28V
 0.03A 0.03A

Approvals **Function** **Category** **CRN**
ADR Front 49/00 42840

Fitting Instructions

Horizontally mount bracket onto flat surface with screws provided, run wires through back and clip lens into place. Please refer to ADR 13/00 for mounting instructions.

Technical Drawings

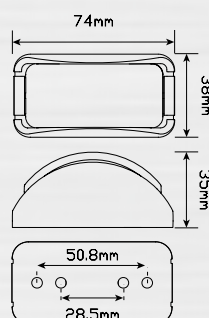

Blister Packaging



44 Series Marker Lamps

- European Slimline design
- Available with 90° angle bracket
- 5 Year warranty



Part Number

- 44RME** - Multivolt 12-24V, Blister single
- 44RMEB** - Multivolt 12-24V, Bulk poly bag
- 44RMEB2P** - Multivolt 12-24V, Bulk boxed with 2C plugs
- 44RMEB6P** - Multivolt 12-24V, Bulk boxed 6 meter cable

Function Rear end outline marker with red reflector
Size 100mm x 44mm x 12mm
Voltage Multivolt 12-24V
LED Qty 3
Cable 50cm cable or 10cm with plugs or 6 meter cable

Draw @13.8V @28V
 0.12A 0.04A

Approvals	Function	Category	CRN
ECE	Rear end	02-R1	6282
ECE	Reflector	02 1A	1472



Part Number

- 44AME** - Multivolt 12-24V, Blister single
- 44AMEB** - Multivolt 12-24V, Bulk poly bag
- 44AMEB2P** - Multivolt 12-24V, Bulk boxed with 2C plugs
- 44AMEB6P** - Multivolt 12-24V, Bulk boxed 6 meter cable

Function Side marker with amber reflector
Size 100mm x 44mm x 12mm
Voltage Multivolt 12-24V
LED Qty 3
Cable 50cm cable or 10cm with plugs or 6 meter cable

Draw @13.8V @28V
 0.12A 0.04A

Approvals	Function	Category	CRN
ECE	Side	00-SM1	1331
ECE	Reflector	02 1A	1014



Part Number

- 44ARMLB** - Multivolt 12-24V, Bulk poly bag
- 44ARMRB** - Multivolt 12-24V, Bulk poly bag

Function Side marker with amber reflector
Size 100mm x 44mm x 12mm
Voltage Multivolt 12-24V
LED Qty 4
Cable 50cm cable

Draw @13.8V @28V
 0.03A 0.04A

Approvals	Function	Category	CRN
ADR	Side	45/01	TBA
ECE	Reflector	02 1A	1014

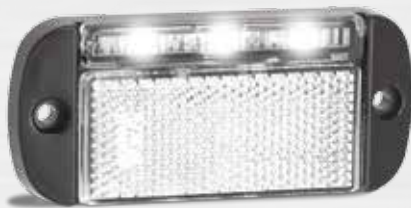

Part Number

- 44WME** - Multivolt 12-24V, Blister single
- 44WMEB** - Multivolt 12-24V, Bulk poly bag
- 44WMEB2P** - Multivolt 12-24V, Bulk boxed with 2C plugs
- 44WMEB6P** - Multivolt 12-24V, Bulk boxed 6 meter cable

Function Front end outline marker with white reflector
Size 100mm x 44mm x 12mm
Voltage Multivolt 12-24V
LED Qty 3
Cable 50cm cable or 10cm with plugs or 6 meter cable

Draw @13.8V @28V
 0.02A 0.03A

Approvals	Function	Category	CRN
ECE	Front	02A	6283
ECE	Reflector	02 1A	1205

Fitting Instructions

Surface mount onto flat surface horizontally with screws, run wire through hole in fixing surface. Please refer to ADR 13/00 for mounting instructions.

Accessories



Black plastic bracket
 44BKT - 90° bracket

Technical Drawings

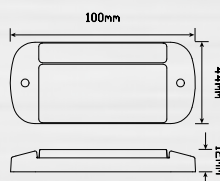

Blister Packaging



38 Series Marker Lamps

- Combination marker/reflector
- Magnetic base available
- 5 Year warranty



Part Number

- 38RM** - Multivolt 12-24V, Blister single
- 38RMB** - Multivolt 12-24V, Bulk poly bag
- 38RMMB** - Multivolt 12-24V, Magnetic type, Bulk poly bag

Function	Rear end outline marker with reflector
Size	135mm x 38mm x 22mm
Voltage	Multivolt 12-24V
LED Qty	4
Cable	40cm cable
Draw	@13.8V @28V 0.05A 0.06A

Approvals	Function	Category	CRN
ADR	Rear end	49/00	40352
ADR	Reflector	47/00	38101



Part Number

- 38AM** - Multivolt 12-24V, Blister single
- 38AMB** - Multivolt 12-24V, Bulk poly bag
- 38AMMB** - Multivolt 12-24V, Magnetic type, Bulk poly bag

Function	Side direction indicator with reflector and side marker
Size	135mm x 38mm x 22mm
Voltage	Multivolt 12-24V
LED Qty	4
Cable	40cm cable
Draw	@13.8V @28V 0.06A 0.06A

Approvals	Function	Category	CRN
ADR	Indicator	6/00	40377
ADR	Side	74/00	40385
ADR	Reflector	47/00	38102



Part Number

- 38ARM** - Multivolt 12-24V, Blister single
- 38ARMB** - Multivolt 12-24V, Bulk poly bag
- 38ARMMB** - Multivolt 12-24V, Magnetic type, Bulk poly bag

Function	Side marker with reflector
Size	135mm x 38mm x 22mm
Voltage	Multivolt 12-24V
LED Qty	4
Cable	40cm cable
Draw	@13.8V @28V 0.06A 0.06A

Approvals	Function	Category	CRN
ADR	Side	45/01	40302
ADR	Reflector	47/00	38102



Part Number

- 38WM** - Multivolt 12-24V, Blister single
- 38WMB** - Multivolt 12-24V, Bulk poly bag
- 38WMMB** - Multivolt 12-24V, Magnetic type, Bulk poly bag

Function	Front end outline marker with reflector
Size	135mm x 38mm x 22mm
Voltage	Multivolt 12-24V
LED Qty	4
Cable	40cm cable
Draw	@13.8V @28V 0.05A 0.05A

Approvals	Function	Category	CRN
ADR	Front	49/00	40353
ADR	Reflector	47/00	38103

Fitting Instructions

Remove bezel and surface mount lamp horizontally onto flat surface with screws provided, run wires through back and clip bezel into place. Please refer to ADR 13/00 for mounting instructions.



Magnetic version with foam gasket

Technical Drawings

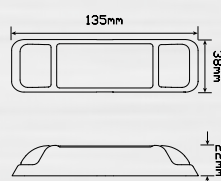

Blister Packaging



38 Series Marker Lamps

- Combination marker/reflector
- 90° Mounting bracket
- 5 Year warranty



Part Number
38RMBKT - Multivolt 12-24V, Blister single

Function Rear end outline marker with reflector
Size 160mm x 62mm x 42mm
Voltage Multivolt 12-24V
LED Qty 4
Cable 40cm cable
Draw @13.8V @28V
 0.05A 0.06A

Approvals	Function	Category	CRN
ADR	Rear end	49/00	40352
ADR	Reflector	47/00	38101



Part Number
38AMBKT - Multivolt 12-24V, Blister single

Function Side direction indicator with reflector and side marker
Size 160mm x 62mm x 42mm
Voltage Multivolt 12-24V
LED Qty 4
Cable 40cm cable
Draw @13.8V @28V
 0.06A 0.06A

Approvals	Function	Category	CRN
ADR	Indicator	6/00	40377
ADR	Side	74/00	40385
ADR	Reflector	47/00	38102



Part Number
38ARMBKT - Multivolt 12-24V, Blister single
38ARMBKTR - Multivolt 12-24V, RHS Blister single

Function Side marker with reflector
Size 160mm x 62mm x 42mm
Voltage Multivolt 12-24V
LED Qty 4
Cable 40cm cable
Draw @13.8V @28V
 0.06A 0.06A

Approvals	Function	Category	CRN
ADR	Side	45/01	40302
ADR	Reflector	47/00	38102



Part Number
38WMBKT - Multivolt 12-24V, Blister single

Function Front end outline marker with reflector
Size 160mm x 62mm x 42mm
Voltage Multivolt 12-24V
LED Qty 4
Cable 40cm cable
Draw @13.8V @28V
 0.05A 0.05A

Approvals	Function	Category	CRN
ADR	Front	49/00	40353
ADR	Reflector	47/00	38103

Fitting Instructions

Horizontally mount lamp onto flat surface with 90° bracket and screws provided, run wires at back through middle hole in bracket. Please refer to ADR 13/00 for mounting instructions.

Accessories

38BB - Black Bracket
 38BC - Chrome Bracket

Technical Drawings

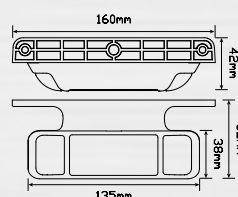

Blister Packaging



EU 38 Series Marker Lamps

- Easy to fit - no tools required
- Serrated plug and 3M tape
- 5 Year warranty



Part Number

EU38RM - Multivolt 12-24V, Blister pack
EU38RMB - Multivolt 12-24V, Bulk poly bag

Function Rear end outline marker with reflector
Size 100mm x 38mm x 13mm
Voltage Multivolt 12-24V
LED Qty 3
Cable 10cm cable
Draw @13.8V @28V
 0.01A 0.01A

Approvals	Function	Category	CRN
ECE	Rear end	02R1	11294
ECE	Reflector	021A	11294



Part Number

EU38AM - Multivolt 12-24V, Blister pack
EU38AMB - Multivolt 12-24V, Bulk poly bag

Function Side marker with reflector
Size 100mm x 38mm x 13mm
Voltage Multivolt 12-24V
LED Qty 3
Cable 10cm cable
Draw @13.8V @28V
 0.01A 0.01A

Approvals	Function	Category	CRN
ECE	Side	00SM1	1304
ECE	Reflector	021A	1304



Part Number

EU38WM - Multivolt 12-24V, Blister pack
EU38WMB - Multivolt 12-24V, Bulk poly bag

Function Front end outline marker with reflector
Size 100mm x 38mm x 13mm
Voltage Multivolt 12-24V
LED Qty 3
Cable 10cm cable
Draw @13.8V @28V
 0.01A 0.01A

Approvals	Function	Category	CRN
ECE	Front	02A	11340
ECE	Reflector	021A	11340

Fitting Instructions

Drill two 6mm holes for serrated plugs and one 8mm hole or larger for the cable. Remove the protective film from the back and simply push into place.

Please refer to ADR 13/00 for mounting instructions.



Technical Drawings

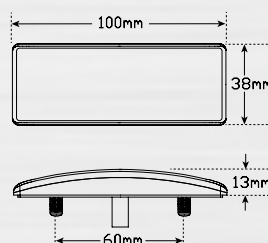

Blister Packaging



Recessed Marker Lamps

- European style design
- Low profile only 5mm
- 5 Year warranty



Part Number
181RME - Multivolt 12-24V, Blister single

Function	Rear end outline marker
Size	28mm round x 5mm high
Voltage	Multivolt 12-24V
LED Qty	3
Cable	20cm cable
Draw	@13.8V @28V 0.03A 0.03A

Approvals	Function	Category	CRN
ECE	Rear	02R1	6257



Part Number
181AME - Multivolt 12-24V, Blister single

Function	Side marker
Size	28mm round x 5mm high
Voltage	Multivolt 12-24V
LED Qty	3
Cable	20cm cable
Draw	@13.8V @28V 0.03A 0.03A

Approvals	Function	Category	CRN
ECE	Side	00 SM1	1005



Part Number
181WME - Multivolt 12-24V, Blister single

Function	Front end outline marker
Size	28mm round x 5mm high
Voltage	Multivolt 12-24V
LED Qty	3
Cable	20cm cable
Draw	@13.8V @28V 0.03A 0.03A

Approvals	Function	Category	CRN
ECE	Front	02A	6258

Fitting Instructions

Mount onto flat surface. Drill 20mm hole for cutout and push lamp with rubber housing into the cutout hole. Please refer to ADR13/00.

Technical Drawings

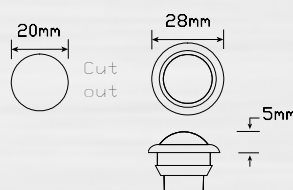

Blister Packaging



1490 Series Marker Lamps

- European style design
- In-built reflector
- 5 Year warranty



Part Number

1490RM - Multivolt 12-24V, Bulk boxed

1491RM - Multivolt 12-24V, 90°Bracket, Bulk boxed

Function Rear end outline marker with reflector
Size 110mm x 40mm x 25mm
Voltage Multivolt 12-24V
LED Qty 4
Cable 20cm cable

Draw @13.8V @28V
 0.05A 0.07A

Approvals	Function	Category	CRN
ECE	Rear end	02-R1	1357



Part Number

1490AM - Multivolt 12-24V, Bulk boxed

1491AM - Multivolt 12-24V, 90°Bracket, Bulk boxed

Function Side marker with reflector
Size 110mm x 40mm x 25mm
Voltage Multivolt 12-24V
LED Qty 4
Cable 20cm cable

Draw @13.8V @28V
 0.05A 0.07A

Approvals	Function	Category	CRN
ECE	Side	00-SM1	1354



Part Number

1490WM - Multivolt 12-24V, Bulk boxed

1491WM - Multivolt 12-24V, 90°Bracket, Bulk boxed

Function Front end outline marker with reflector
Size 110mm x 40mm x 25mm
Voltage Multivolt 12-24V
LED Qty 4
Cable 20cm cable

Draw @13.8V @28V
 0.05A 0.04A

Approvals	Function	Category	CRN
ECE	Front	02A	1358

Fitting Instructions

Horizontally mount lamp onto flat surface, remove lens from base and fix with screws provided. Please refer to ADR 13/00 for mounting instructions.

Technical Drawings

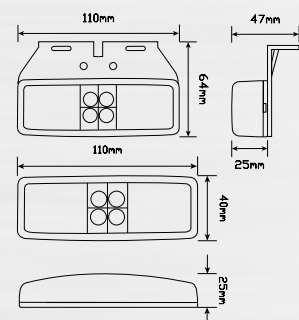

Recessed Marker Lamps

- Rubber housing design
- Shock, dust and waterproof
- 5 Year warranty



Part Number
1477R - 12 Volt, Bulk poly bag
12761 - Grommet
3591 - Plug

Function Rear end outline marker
Size 71mm round x 12mm high
Voltage 12 Volt
LED Qty 3
Plug use Part Number 3591
Draw @13.8V
 0.04A

Approvals DOT/SAE	Function	Category	CRN
Rear		N/A	N/A



Part Number
1477A - 12 Volt, Bulk poly bag
12761 - Grommet
3591 - Plug

Function Side marker
Size 71mm round x 12mm high
Voltage 12 Volt
LED Qty 3
Plug use Part Number 3591
Draw @13.8V
 0.04A

Approvals DOT/SAE	Function	Category	CRN
Side		N/A	N/A



Part Number
1479R - 12 Volt, Bulk poly bag
12781 - Grommet
3591 - Plug

Function Rear end outline marker
Size 94mm round x 8mm high
Voltage 12 Volt
LED Qty 4
Plug use Part Number 3591
Draw @13.8V
 0.04A

Approvals DOT/SAE	Function	Category	CRN
Rear		N/A	N/A



Part Number
1479A - 12 Volt, Bulk poly bag
12781 - Grommet
3591 - Plug

Function Side marker
Size 94mm round x 8mm high
Voltage 12 Volt
LED Qty 4
Plug use Part Number 3591
Draw @13.8V
 0.05A

Approvals DOT/SAE	Function	Category	CRN
Side		N/A	N/A

Fitting Instructions

Fit grommet into cut out in fixing surface, run wires through back and plug into back of lamp, push lamp into grommet.

Accessories

12761 - 1477 Grommet
 12781 - 1479 Grommet
 3591 - Plug

Technical Drawings

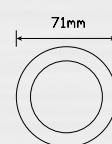

1477 Cut out Ø58mm

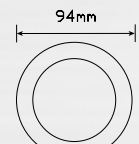

1479 Cut out Ø76mm

Rubber Marker Lamps

- Rubber housing design
- Shock and vibration proof
- 5 Year warranty



Function	Red/amber side marker		
Size	193mm x 169mm x 66mm		
Voltage	Multivolt 12-24V		
LED Qty	6		
Cable	40cm cable from lens		
Draw	Red	Amber	
@13.8V	0.03A	0.06A	
@28V	0.04A	0.06A	
Approvals	Function	Category	CRN
ADR	Side	45/01	43129

Part Number

1004R - Multivolt 12-24V, RHS Bulk poly bag

1004L - Multivolt 12-24V, LHS Bulk poly bag



Function	Side markers		
Size	101mm x 66mm x 82mm		
Voltage	Multivolt 12-24V		
LED Qty	3		
Cable	40cm cable		
Draw	Red	Amber	
@13.8V	0.03A	0.06A	
@28V	0.04A	0.06A	
Approvals	Function	Category	CRN
ADR	Side	45/01	43129

Part Number

1004ARM - Multivolt 12-24V, Bulk poly bag

Fitting Instructions

Fix to flat surface, amber facing forward and red facing to the back with two bolts supplied.

Technical Drawings

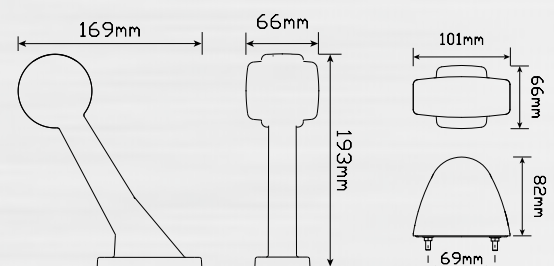

Marker Lamps

- American style design
- Shock, dust & water proof
- 5 Year warranty



Part Number
1282R - 12 Volt, Bulk poly bag

Function Rear end outline marker
Size 79mm x 51mm x 24mm
Voltage 12 Volt
LED Qty 2
Cable 13cm cable
Draw @13.8V
 0.06A

Approvals **Function** **Category** **CRN**
DOT/SAE Rear end N/A N/A



Part Number
1282A - 12 Volt, Bulk poly bag

Function Side marker
Size 79mm x 51mm x 24mm
Voltage 12 Volt
LED Qty 2
Cable 13cm cable
Draw @13.8V
 0.05A

Approvals **Function** **Category** **CRN**
DOT/SAE Side N/A N/A



Part Number
1369R - 12 Volt, Bulk poly bag

Function Rear end outline marker
Size 102mm x 19mm x 35mm
Voltage 12 Volt
LED Qty 7
Cable 16cm hard wired with round connectors
Draw @13.8V
 0.05A

Approvals **Function** **Category** **CRN**
DOT/SAE Rear end N/A N/A

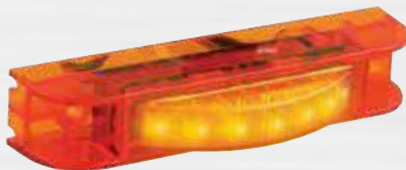

Part Number
1369A - 12 Volt, Bulk poly bag

Function Side marker
Size 102mm x 19mm x 35mm
Voltage 12 Volt
LED Qty 7
Cable 16cm hard wired with round connectors
Draw @13.8V
 0.05A

Approvals **Function** **Category** **CRN**
DOT/SAE Side N/A N/A

Fitting Instructions

Surface mount lamp with screws, run wires at back of lamp through hole in mounting surface.

Technical Drawings

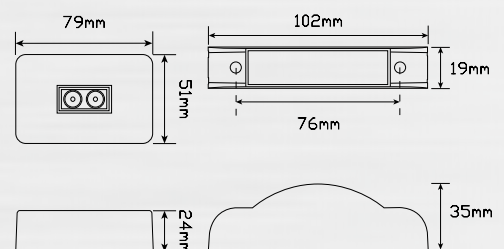

Marker Lamps

- American design with in-built reflector
- Shock, dust & water proof
- 5 Year warranty



Part Number
1685RB - 12 Volt, Bulk poly bag

Function Rear end outline marker
Size 152mm x 52mm x 29mm
Voltage 12 Volt
LED Qty 3
Cable 30cm cable
Draw @13.8V
0.05A

Approvals	Function	Category	CRN
DOT/SAE	Rear end	N/A	N/A



Part Number
1685AM - Multivolt 12-24V, Bulk poly bag
1685AB - 12 Volt only - Poly Bag

ADR
Approved

Function Side marker
Size 152mm x 52mm x 29mm
Voltage Multivolt 12-24V
LED Qty 3
Cable 30cm cable
Draw @13.8V @28V
0.05A 0.04A

Approvals	Function	Category	CRN
ADR	Side	45/01	39221
ADR	Reflector	47/00	39222



Part Number
1284R- 12 Volt, Bulk poly bag

Function Rear end outline marker
Size 149mm x 52mm x 35mm
Voltage 12 Volt
LED Qty 8
Cable 15cm cable
Draw @13.8V
0.05A

Approvals	Function	Category	CRN
DOT/SAE	Rear end	N/A	N/A



Part Number
1284A- 12 Volt, Bulk poly bag

Function Side marker
Size 149mm x 52mm x 35mm
Voltage 12 Volt
LED Qty 8
Cable 15cm cable
Draw @13.8V
0.05A

Approvals	Function	Category	CRN
DOT/SAE	Side	N/A	N/A

Fitting Instructions

Surface mount lamp horizontally to the ground with screws provided, run wires through back. Please refer to ADR 13/00 for mounting instructions.

Technical Drawings

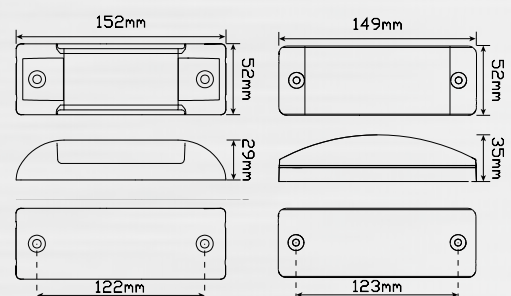

Marker Lamps

- American style design
- Shock, dust and water proof
- 5 Year warranty



Part Number

- 1459R - 12 Volt, Bulk poly bag
- 12572 - Black Bracket
- 12571 - Chrome Bracket



Function Rear end outline marker
Side marker
Front end outline marker

Size 74mm x 38mm x 25mm

Voltage 12 Volt

LED Qty 3

Cable 20cm cable

Draw @13.8V
0.05A - 0.06A

Part Number

- 1459A - 12 Volt, Bulk poly bag
- 12572 - Black Bracket
- 12571 - Chrome Bracket



Approvals	Function	Category	CRN
DOT/SAE	Marker	N/A	N/A

Part Number

- 1459W - 12 Volt, Bulk poly bag
- 12572 - Black Bracket
- 12571 - Chrome Bracket



Fitting Instructions

Lamps require bracket for fitting.
Fit bracket to fixing surface run wire through back of base and plug into positive outlet in back of lamp, push lamp into base with negative outlet slotting into female earth in base.

Technical Drawings

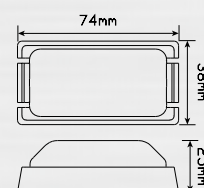

Marker Lamps

- American style design
- Shock, dust and water proof
- 5 Year warranty



Part Number

- 1474R - 12 Volt, Bulk poly bag
- 12612 - Black Bracket
- 12611 - Chrome Bracket



Function Rear end outline marker
Side marker
Front end outline marker

Size 105mm x 31mm x 30mm

Voltage 12 Volt

LED Qty 3

Cable 20cm cable

Draw @13.8V
0.04A

Part Number

- 1474A - 12 Volt, Bulk poly bag
- 12612 - Black Bracket
- 12611 - Chrome Bracket



Approvals	Function	Category	CRN
DOT/SAE	Marker	N/A	N/A

Part Number

- 1474W - 12 Volt, Bulk poly bag
- 12612 - Black Bracket
- 12611 - Chrome Bracket



Fitting Instructions

Lamps require bracket for fitting. Fit bracket to fixing surface run wire through back of base and plug into positive outlet in back of lamp, push lamp into base with negative outlet slotting into female earth in base.

Technical Drawings

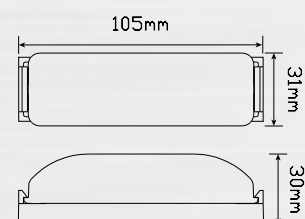

White Surround Coloured Lens Marker Lamps

- Ideal for the caravan industry
- Low profile
- 5 Year warranty



Part Number
57WRM - Multivolt 12-24V, Bulk poly bag

Function	Rear end outline marker		
Size	168mm x 57mm x 17mm		
Voltage	Multivolt 12-24V		
LED Qty	4		
Cable	10cm cable		
Draw	@13.8V	@28V	
	0.05A	0.06A	
Approvals	Function	Category	CRN
ADR	Rear end	49/00	45147



Part Number
57WAM - Multivolt 12-24V, Bulk poly bag

Function	Side marker		
Size	168mm x 57mm x 17mm		
Voltage	Multivolt 12-24V		
LED Qty	4		
Cable	10cm cable		
Draw	@13.8V	@28V	
	0.05A	0.06A	
Approvals	Function	Category	CRN
ADR	Side	45/01	45146



Part Number
57WWM - Multivolt 12-24V, Bulk poly bag

Function	Front end outline marker		
Size	168mm x 57mm x 17mm		
Voltage	Multivolt 12-24V		
LED Qty	4		
Cable	10cm cable		
Draw	@13.8V	@28V	
	0.05A	0.03A	
Approvals	Function	Category	CRN
ADR	Front	49/00	45148

Fitting Instructions

Remove bezel from assembly and surface mount horizontally using screws included, then refit bezel. Please refer to ADR 13/00 for mounting instructions.

Technical Drawings

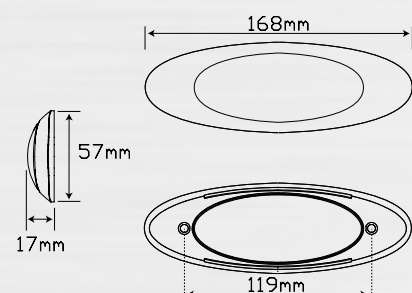

White Surround Coloured Lens Marker Lamps

- Ideal for the caravan industry
- 12mm low profile design
- 5 Year warranty



Part Number

- 44WRME** - Multivolt 12-24V, Blister single
- 44WRMEB2P** - Multivolt 12-24V, Bulk boxed with 2C plugs
- 44WRMEB6P** - Multivolt 12-24V, Bulk boxed 6 meter cable

Function	Rear end outline marker with red reflector		
Size	100mm x 44mm x 12mm		
Voltage	Multivolt 12-24V		
LED Qty	3		
Cable	50cm cable or 10cm with plugs or 6 meter cable		
Draw	@13.8V	@28V	
	0.12A	0.04A	
Approvals	Function	Category	CRN
ECE	Rear end	02-R1	6282
ECE	Reflector	02 1A	1472



Part Number

- 44WAME** - Multivolt 12-24V, Blister single
- 44WAMEB2P** - Multivolt 12-24V, Bulk poly bag with 2C plugs
- 44WAMEB6P** - Multivolt 12-24V, Bulk poly bag 6 meter cable

Function	Side marker with amber reflector		
Size	100mm x 44mm x 12mm		
Voltage	Multivolt 12-24V		
LED Qty	3		
Cable	50cm cable or 10cm with plugs or 6 meter cable		
Draw	@13.8V	@28V	
	0.12A	0.04A	
Approvals	Function	Category	CRN
ECE	Side	00-SM1	1331
ECE	Reflector	02 1A	1014



Part Number

- 44WARMLB** - Multivolt 12-24V, LHS, Bulk poly bag
- 44WARMRB** - Multivolt 12-24V, RHS, Bulk poly bag

Function	Side marker with amber reflector		
Size	100mm x 44mm x 12mm		
Voltage	Multivolt 12-24V		
LED Qty	4		
Cable	50cm cable		
Draw	@13.8V	@28V	
	0.03A	0.04A	
Approvals	Function	Category	CRN
ADR	Side	45/01	TBA
ECE	Reflector	02 1A	1014



Part Number

- 44WWME** - Multivolt 12-24V, Blister single
- 44WWMEB2P** - Multivolt 12-24V, Bulk poly bag with 2C plugs
- 44WWMEB6P** - Multivolt 12-24V, Bulk poly bag 6 meter cable

Function	Front end outline marker with white reflector		
Size	100mm x 44mm x 12mm		
Voltage	Multivolt 12-24V		
LED Qty	3		
Cable	50cm cable or 10cm with plugs or 6 meter cable		
Draw	@13.8V	@28V	
	0.02A	0.03A	
Approvals	Function	Category	CRN
ECE	Front	02A	6283
ECE	Reflector	02 1A	1205

Fitting Instructions

Surface mount onto flat surface horizontally with screws, run wire through hole in fixing surface. Please refer to ADR 13/00 for mounting instructions.

Technical Drawings

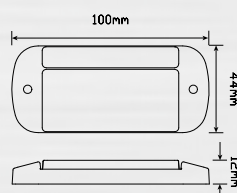

Blister Packaging



Chrome Surround Coloured Lens Marker Lamps

- Premium original design
- Low profile
- 5 Year warranty



Part Number

35CRM - Multivolt 12-24V, Blister single
35CRMB - Multivolt 12-24V, Bulk poly bag

Function Rear end outline marker
Size 58mm x 35mm x 21mm
Voltage Multivolt 12-24V
LED Qty 4
Cable 40cm cable
Draw @13.8V @28V
 0.12A 0.07A

Approvals	Function	Category	CRN
ADR	Rear end	49/00	34007



Part Number

35CAM - Multivolt 12-24V, Blister single
35CAMB - Multivolt 12-24V, Bulk poly bag

Function Side direction indicator
Size 58mm x 35mm x 21mm
Voltage Multivolt 12-24V
LED Qty 4
Cable 40cm cable
Draw @13.8V @28V
 0.10A 0.07A

Approvals	Function	Category	CRN
ADR	Indicator	6/00	33894



Part Number

35CARM - Multivolt 12-24V, Blister single
35CARMB - Multivolt 12-24V, Bulk poly bag

Function Side marker
Size 58mm x 35mm x 21mm
Voltage Multivolt 12-24V
LED Qty 4
Cable 40cm cable
Draw @13.8V @28V
 0.10A 0.07A

Approvals	Function	Category	CRN
ADR	Side	45/01	34099



Part Number

35CWM - Multivolt 12-24V, Blister single
35CWMB - Multivolt 12-24V, Bulk poly bag

Function Front end outline marker
Size 58mm x 35mm x 21mm
Voltage Multivolt 12-24V
LED Qty 4
Cable 40cm cable
Draw @13.8V @28V
 0.05A 0.04A

Approvals	Function	Category	CRN
ADR	Front	49/00	34008

Fitting Instructions

Horizontally mount bracket onto flat surface with screws provided, run wires through back and clip lens into place. Please refer to ADR 13/00 for mounting instructions.

Technical Drawings

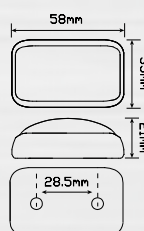

Blister Packaging



Chrome Surround Coloured Lens Marker Lamps

- New lens design
- Low profile
- 5 Year warranty



Part Number
58CRM - Multivolt 12-24V, Blister single
58CRMB10P - Multivolt 12-24V, Bulk boxed 10 pack
58CRM3 - Multivolt 12-24V, 3m Cable, Bulk poly bag

Function Rear end outline marker
Size 58mm x 35mm x 21mm
Voltage Multivolt 12-24V
LED Qty 2
Cable 40cm Cable or 10cm with plugs or 3 metre cable

Draw @13.8V @28V
 0.12A 0.04A

Approvals **Function** **Category** **CRN**
ADR Rear end 49/00 36840



Part Number
58CAM - Multivolt 12-24V, Blister single
58CAMB10P - Multivolt 12-24V, Bulk boxed 10 pack
58CAM3 - Multivolt 12-24V, 3m Cable, Bulk poly bag

Function Side direction indicator
Size 58mm x 35mm x 21mm
Voltage Multivolt 12-24V
LED Qty 3
Cable 40cm Cable or 10cm with plugs or 3 metre cable

Draw @13.8V @28V
 0.10A 0.04A

Approvals **Function** **Category** **CRN**
ADR Indicator 6/00 38277



Part Number
58CARM - Multivolt 12-24V, Blister single
58CARMB10P - Multivolt 12-24V, Bulk boxed 10 pack
58CARM3 - Multivolt 12-24V, 3m Cable, Bulk poly bag

Function Side marker
Size 58mm x 35mm x 21mm
Voltage Multivolt 12-24V
LED Qty 2
Cable 40cm Cable or 10cm with plugs or 3 metre cable

Draw @13.8V @28V
 0.10A 0.040A

Approvals **Function** **Category** **CRN**
ADR Side 45/01 36841



Part Number
58CWM - Multivolt 12-24V, Blister single
58CWMB10P - Multivolt 12-24V, Bulk boxed 10 pack
58CWM3 - Multivolt 12-24V, 3m Cable, Bulk poly bag

Function Front end outline marker
Size 58mm x 35mm x 21mm
Voltage Multivolt 12-24V
LED Qty 2
Cable 40cm Cable or 10cm with plugs or 3 metre cable

Draw @13.8V @28V
 0.05A 0.03A

Approvals **Function** **Category** **CRN**
ADR Front 49/00 36842

Fitting Instructions

Horizontally mount bracket onto flat surface with screws provided, run wires through back and clip lens into place. Please refer to ADR 13/00 for mounting instructions.

Technical Drawings

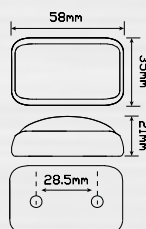

Blister Packaging



Chrome Surround Coloured Lens Marker Lamps

- Easiest to fit - No tools required
- Serrated plug and 3M tape
- 5 Year warranty



Part Number
37CRM2P - Multivolt 12-24V, Blister Single
37CRMB2P - Multivolt 12-24V, Bulk boxed

Function Rear end outline marker
Size 70mm x 35mm x 20mm
Voltage Multivolt 12-24V
LED Qty 2
Cable 10cm with specially designed plugs

Draw @13.8V @28V
 0.04A 0.04A

Approvals **Function** **Category** **CRN**
ECE Rear end 02R1 6917



Part Number
37CAM2P - Multivolt 12-24V, Blister Single
37CAMB2P - Multivolt 12-24V, Bulk boxed

Function Side direction indicator
Size 70mm x 35mm x 20mm
Voltage Multivolt 12-24V
LED Qty 2
Cable 10cm with specially designed plugs

Compliance ECE 00SM1 - CRN 1017

Draw @13.8V @28V
 0.04A 0.04A

Approvals **Function** **Category** **CRN**
ECE Indicator 00SM1 1017



Part Number
37CARM2P - Multivolt 12-24V, Blister Single
37CARMB2P - Multivolt 12-24V, Bulk boxed

Function Side marker
Size 70mm x 35mm x 20mm
Voltage Multivolt 12-24V
LED Qty 2
Cable 10cm with specially designed plugs

Draw @13.8V @28V
 0.04A 0.04A

Approvals **Function** **Category** **CRN**
ADR Side 45/01 43515



Part Number
37CWM2P - Multivolt 12-24V, Blister Single
37CWMB2P - Multivolt 12-24V, Bulk boxed

Function Front end outline marker
Size 70mm x 35mm x 20mm
Voltage Multivolt 12-24V
LED Qty 2
Cable 10cm with specially designed plugs

Draw @13.8V @28V
 0.04A 0.04A

Approvals **Function** **Category** **CRN**
ECE Front 02A 6918

Fitting Instructions

Drill two 6mm holes for serrated plugs and one 8mm hole or larger for the cable. Remove the protective film from the back and simply push into place. Please refer to ADR 13/00 for mounting instructions.

Technical Drawings

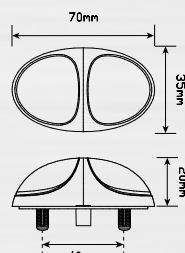

Blister Packaging



Chrome Surround Coloured Lens Marker Lamps

- Combination marker/reflector
- Easy fitment
- 5 Year warranty



Part Number
38CRM - Multivolt 12-24V, Blister single

Function	Rear end outline marker with reflector		
Size	135mm x 38mm x 22mm		
Voltage	Multivolt 12-24V		
LED Qty	4		
Cable	40cm cable		
Draw	@13.8V	@28V	
	0.05A	0.06A	
Approvals	Function	Category	CRN
ADR	Rear end Reflector	49/00 47/00	40352 38101



Part Number
38CAM - Multivolt 12-24V, Blister single

Function	Side direction indicator/ side marker with reflector		
Size	135mm x 38mm x 22mm		
Voltage	Multivolt 12-24V		
LED Qty	4		
Cable	40cm cable		
Draw	@13.8V	@28V	
	0.06A	0.06A	
Approvals	Function	Category	CRN
ADR	Indicator Side Reflector	6/00 74/00 47/00	40377 40385 38102



Part Number
38CARM - Multivolt 12-24V, Blister single
38CARMB - Multivolt 12-24V, Bulk poly bag

Function	Side marker with reflector		
Size	135mm x 38mm x 22mm		
Voltage	Multivolt 12-24V		
LED Qty	4		
Cable	40cm cable		
Draw	@13.8V	@28V	
	0.06A	0.06A	
Approvals	Function	Category	CRN
ADR	Side Reflector	45/01 47/00	40302 38102



Part Number
38CWM - Multivolt 12-24V, Blister single

Function	Front end outline marker with reflector		
Size	135mm x 38mm x 22mm		
Voltage	Multivolt 12-24V		
LED Qty	4		
Cable	40cm cable		
Draw	@13.8V	@28V	
	0.05A	0.05A	
Approvals	Function	Category	CRN
ADR	Front Reflector	49/00 47/00	40353 38103

Fitting Instructions

Remove bezel and surface mount lamp horizontally onto flat surface with screws provided, run wires through back and clip bezel into place. Please refer to ADR 13/00 for mounting instructions.

Technical Drawings

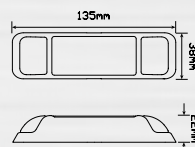

Blister Packaging



Chrome Surround Coloured Lens Marker Lamps

- American style design
- Shock, dust & water proof
- 5 Year warranty



Part Number
1440R - 12 Volt, Bulk poly bag

Function Rear end outline marker
Size 96mm x 58mm x 49mm
Voltage 12 Volt
LED Qty 3
Cable 10cm cable
Draw @13.8V
 0.04A

Approvals	Function	Category	CRN
DOT/SAE	Rear end	N/A	N/A



Part Number
1440A - 12 Volt, Bulk poly bag

Function Side marker
Size 96mm x 58mm x 49mm
Voltage 12 Volt
LED Qty 3
Cable 10cm cable
Draw @13.8V
 0.03A

Approvals	Function	Category	CRN
DOT/SAE	Side	N/A	N/A



Part Number
1440W - 12 Volt, Bulk poly bag

Function Front end outline marker
Size 96mm x 58mm x 49mm
Voltage 12 Volt
LED Qty 3
Cable 10cm cable
Draw @13.8V
 0.03A

Approvals	Function	Category	CRN
DOT/SAE	Front	N/A	N/A

Fitting Instructions

Remove screws from front of lens, run wires through rubber grommet and 23mm hole in fixing surface. Place bracket horizontally and fix with self tapping screw in assembly, ensure "TOP" is at the top, and then refix lens into place with screws.

Technical Drawings

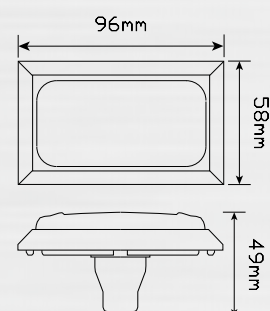

Chrome Surround Coloured Lens Marker Lamps

- American design
- Shock, dust & water proof
- 5 Year warranty



Part Number
1388R - 12 Volt, Bulk poly bag

Function Rear end outline marker
Size 169mm x 55mm x 24mm
Voltage 12 Volt
LED Qty 16
Cable 20cm cable
Draw @13.8V
 0.07A

Approvals	Function	Category	CRN
DOT/SAE	Rear	N/A	N/A



Part Number
1388A - 12 Volt, Bulk poly bag

Function Side marker
Size 169mm x 55mm x 24mm
Voltage 12 Volt
LED Qty 16
Cable 20cm cable
Draw @13.8V
 0.12A

Approvals	Function	Category	CRN
DOT/SAE	Side	N/A	N/A



Part Number
1388W - 12 Volt, Bulk poly bag

Function Front end outline marker
Size 169mm x 55mm x 24mm
Voltage 12 Volt
LED Qty 16
Cable 20cm cable
Draw @13.8V
 0.24A

Approvals	Function	Category	CRN
DOT/SAE	Front	N/A	N/A

Fitting Instructions

Remove bezel from assembly and surface mount horizontally using screws included, then refit bezel. Please refer to ADR 13/00 for mounting instructions.

Technical Drawings

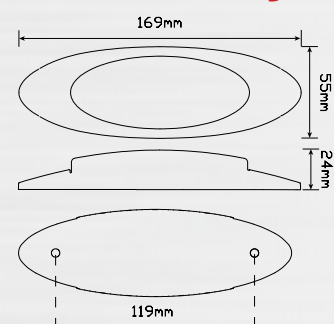

**Clear lens
Coloured LEDs
Chrome surround**

- Premium original design
- Low profile
- 5 Year warranty



Part Number
35CCRM - Multivolt 12-24V, Blister single

Function Rear end outline marker
Size 58mm x 35mm x 21mm
Voltage Multivolt 12-24V
LED Qty 4
Cable 40cm cable
2 metre cable

Draw @13.8V @28V
0.12A 0.07A

Approvals **Function** **Category** **CRN**
ADR Rear end 49/00 34007



Part Number
35CCAM - Multivolt 12-24V, Blister single

Function Side direction indicator
Size 58mm x 35mm x 21mm
Voltage Multivolt 12-24V
LED Qty 4
Cable 40cm cable
2 metre cable

Draw @13.8V @28V
0.10A 0.07A

Approvals **Function** **Category** **CRN**
ADR Indicator 6/00/5 33894



Part Number
35CCARM - Multivolt 12-24V, Blister single

Function Side marker
Size 58mm x 35mm x 21mm
Voltage Multivolt 12-24V
LED Qty 4
Cable 40cm cable
2 metre cable

Draw @13.8V @28V
0.10A 0.07A

Approvals **Function** **Category** **CRN**
ADR Side 45/01 34099



Part Number
35CCWM - Multivolt 12-24V, Blister single

Function Front end outline marker
Size 58mm x 35mm x 21mm
Voltage Multivolt 12-24V
LED Qty 4
Cable 40cm cable
2 metre cable

Draw @13.8V @28V
0.05A 0.04A

Approvals **Function** **Category** **CRN**
ADR Front 49/00 34008

Fitting Instructions

Horizontally mount bracket onto flat surface with screws provided, run wires through back and clip lens into place. Please refer to ADR 13/00 for mounting instructions.

Technical Drawings

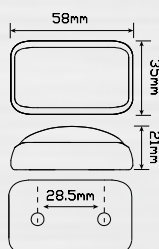

Blister Packaging



**Clear lens
Coloured LEDs
Chrome surround**

- Easiest to fit - No tools required
- Serrated plug and 3M tape
- 5 Year warranty



Part Number
37CCRM2P - Multivolt 12-24V, Blister single

Function Rear end outline marker
Size 70mm x 35mm x 20mm
Voltage Multivolt 12-24V
LED Qty 2
Cable 10cm with specially designed plugs

Draw @13.8V @28V
0,04A 0,04A

Approvals **Function** **Category** **CRN**
ECE Rear end 02R1 6917



Part Number
37CCAM2P - Multivolt 12-24V, Blister single

Function Side direction indicator
Size 70mm x 35mm x 20mm
Voltage Multivolt 12-24V
LED Qty 2
Cable 10cm with specially designed plug

Draw @13.8V @28V
0,04A 0,04A

Approvals **Function** **Category** **CRN**
ECE Indicator 00SM1 1017



Part Number
37CCARM2P - Multivolt 12-24V, Blister single

Function Red/Amber Side marker
Size 70mm x 35mm x 20mm
Voltage Multivolt 12-24V
LED Qty 2
Cable 10cm with specially designed plug

Draw @13.8V @28V
0,04A 0,04A

Approvals **Function** **Category** **CRN**
ADR Side 45/01 43515



Part Number
37CCWM2P - Multivolt 12-24V, Blister single

Function Front end outline marker
Size 70mm x 35mm x 20mm
Voltage Multivolt 12-24V
LED Qty 2
Cable 10cm with specially designed plug

Draw @13.8V @28V
0,04A 0,04A

Approvals **Function** **Category** **CRN**
ECE Front 02A 6918

Fitting Instructions

Drill two 6mm holes for serrated plugs and one 8mm hole or larger for the cable. Remove the protective film from the back and simply push into place. Please refer to ADR 13/00 for mounting instructions.

Technical Drawings

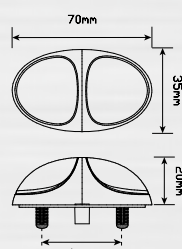

Blister Packaging



**Clear lens
Coloured LEDs
Chrome surround**

- Popular truck style
- Low profile
- 5 Year warranty



Part Number
86RM - Multivolt 12-24, Blister single
86RMB - Multivolt 12-24, Bulk poly bag

Function Rear end outline marker
Size 86mm x 31mm x 10mm
Voltage Multivolt 12-24V
LED Qty 3
Cable 15cm cable
Draw @13.8V @28V
 0.42A 0.72

Approvals	Function	Category	CRN
ADR	Rear end	49/00	TBA



Part Number
86AM - Multivolt 12-24, Blister single
86AMB - Multivolt 12-24, Bulk poly bag

Function Side marker
Size 86mm x 31mm x 10mm
Voltage Multivolt 12-24V
LED Qty 3
Cable 15cm cable
Draw @13.8V @28V
 TBA TBA

Approvals	Function	Category	CRN
ADR	Side	74/00	TBA



Part Number
86WM - Multivolt 12-24, Blister single
86WMB - Multivolt 12-24, Bulk poly bag

Function Front end outline marker
Size 86mm x 31mm x 10mm
Voltage Multivolt 12-24V
LED Qty 3
Cable 15cm cable
Draw @13.8V @28V
 TBA TBA

Approvals	Function	Category	CRN
ADR	Front end	49/00	TBA

Fitting Instructions

Surface mount horizontally.
 Remove stainless steel bezel and fit with screw, then clip bezel back into place. Please refer to ADR 13/00 for mounting instructions.

Technical Drawings

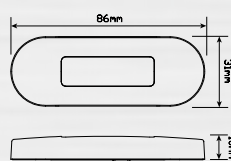

Blister Packaging



**Clear lens
Coloured LEDs
Chrome surround**

- Australian approved design
- Low profile
- 5 Year warranty

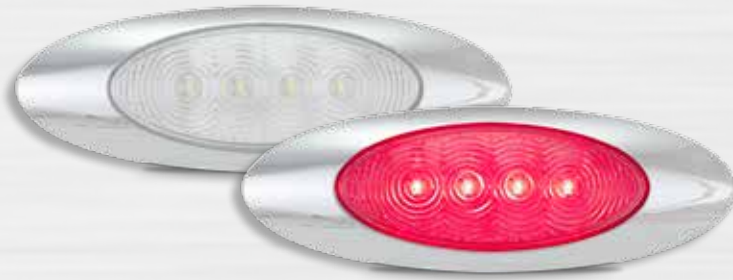

Part Number
57CCRM - Multivolt 12-24V, Blister single

Function	Rear end outline marker		
Size	168mm x 57mm x 17mm		
Voltage	Multivolt 12-24V		
LED Qty	4		
Cable	10cm cable		
Draw	@13.8V	@28V	
	0.05A	0.06A	
Approvals	Function	Category	CRN
ADR	Rear end	49/00	45157

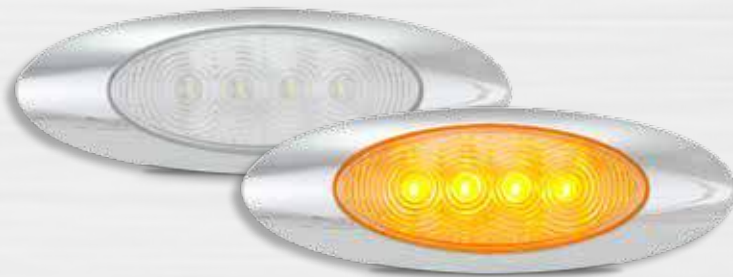

Part Number
57CCAM - Multivolt 12-24V, Blister single

Function	Side marker		
Size	168mm x 57mm x 17mm		
Voltage	Multivolt 12-24V		
LED Qty	4		
Cable	10cm cable		
Draw	@13.8V	@28V	
	0.05A	0.06A	
Approvals	Function	Category	CRN
ADR	Side	45/01	45146

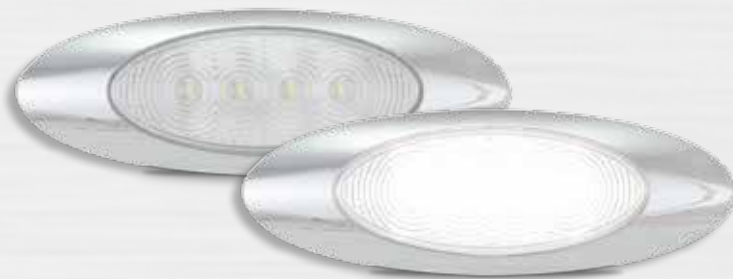

Part Number
57CCWM - Multivolt 12-24V, Blister single

Function	Front end outline marker		
Size	168mm x 57mm x 17mm		
Voltage	Multivolt 12-24V		
LED Qty	4		
Cable	10cm cable		
Draw	@13.8V	@28V	
	0.05A	0.04A	
Approvals	Function	Category	CRN
ADR	Front	49/00	45148

Fitting Instructions

Remove bezel from assembly and surface mount horizontally using screws included, then refit bezel. Please refer to ADR 13/00 for mounting instructions

Technical Drawings

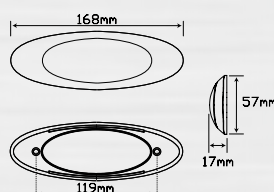

Blister Packaging



Clear Lens Coloured LEDs Chrome Surround

- Clear lens design
- Chunky bulky old style
- 5 Year warranty



Part Number

42CRM - Multivolt 12-24V, Blister single
42CRM10B - Multivolt 12-24V, Bulk boxed 10 pack

Function	Rear end outline marker
Size	74mm x 38mm x 35mm
Voltage	Multivolt 12-24V
LED Qty	2
Cable	16cm cable
Draw	@13.8V @28V 0.05A 0.06A
Approvals	Function Category CRN
ADR	Rear end 49/00 42839



Part Number

42CAM - Multivolt 12-24V, Blister single
42CAM10B - Multivolt 12-24V, Bulk boxed 10 pack

Function	Side direction indicator
Size	74mm x 38mm x 35mm
Voltage	Multivolt 12-24V
LED Qty	3
Cable	16cm cable
Draw	@13.8V @28V 0.05A 0.06A
Approvals	Function Category CRN
ADR	Indicator 6/00 42836



Part Number

42CARM - Multivolt 12-24V, Blister single
42CARM10B - Multivolt 12-24V, Bulk boxed 10 pack

Function	Side marker
Size	74mm x 38mm x 35mm
Voltage	Multivolt 12-24V
LED Qty	2
Cable	16cm cable
Draw	@13.8V @28V 0.05A 0.06A
Approvals	Function Category CRN
ADR	Side 45/01 42837



Part Number

42CWM - Multivolt 12-24V, Blister single
42CWM10B - Multivolt 12-24V, Bulk boxed 10 pack

Function	Front end outline marker
Size	74mm x 38mm x 35mm
Voltage	Multivolt 12-24V
LED Qty	2
Cable	16cm cable
Draw	@13.8V @28V 0.03A 0.03A
Approvals	Function Category CRN
ADR	Front 49/00 42840

Fitting Instructions

Surface mount bracket onto flat surface horizontally with screws provided, run wires through back and clip lens into place. Please refer to ADR 13/00 for mounting instructions.

Technical Drawings

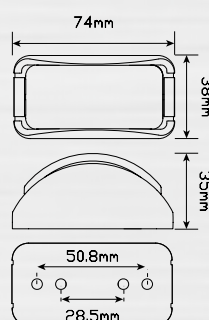

Blister Packaging



Clear Lens Coloured LEDs Chrome Surround

- American design
- Shock, dust & water proof
- 5 Year warranty



Function Rear end outline marker
Size 169mm x 55mm x 24mm
Voltage 12 Volt
LED Qty 16
Cable 20cm cable
Draw @13.8V
 0.07A

Approvals	Function	Category	CRN
DOT/SAE	Rear	N/A	N/A

Part Number

1374R - 12 Volt, Bulk poly bag



Function Side marker
Size 169mm x 55mm x 24mm
Voltage 12 Volt
LED Qty 16
Cable 20cm cable
Draw @13.8V
 0.12A

Approvals	Function	Category	CRN
DOT/SAE	Side	N/A	N/A

Part Number

1374A - 12 Volt, Bulk poly bag

Fitting Instructions

Remove bezel from assembly and surface mount horizontally using screws included, then refit bezel. Please refer to ADR 13/00 for mounting instructions.

Technical Drawings

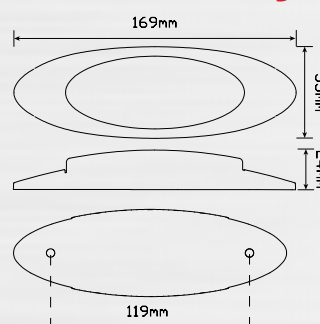

Licence Plate Lamps

- Plugin option available
- Shock, dust & water proof
- 5 Year warranty



Function Licence Plate Lamps
Size 76mm x 42mm x 30mm
Voltage Multivolt 12-24V
LED Qty 4
Cable 40cm cable or 1 metre cable or 6 metre cable

Draw **Licence**
@13.8V 0.04A
@28V 0.04A

Approvals	Function	Category	CRN
ADR	Licence	48/00	36280

Part Number

- 35BLM** - Multivolt 12-24V, Blister single
- 35BLM1P** - Multivolt 12-24V, 1m cable, Blister single
- 35BLMB** - Multivolt 12-24V, Bulk poly bag
- 35BLM6** - Multivolt 12-24V, 6m cable, Bulk poly bag
- 35BLMB2P** - Multivolt 12-24V, 2 Pin plug, Bulk poly bag



Function Licence Plate Lamps
Size 76mm x 42mm x 30mm
Voltage Multivolt 12-24V
LED Qty 4
Cable 40cm cable

Draw **Licence**
@13.8V 0.04A
@28V 0.04A

Approvals	Function	Category	CRN
ADR	Licence	48/00	36280

Part Number

- 35CLM** - Multivolt 12-24V, Blister single
- 35CLMB** - Multivolt 12-24V, Bulk poly bag

Fitting Instructions

Fit onto flat surface, 25mm from top centre, long edge of licence plate with lens facing towards the ground. Refer to ADR 13/00 for Fitting Instructions.

Technical Drawings

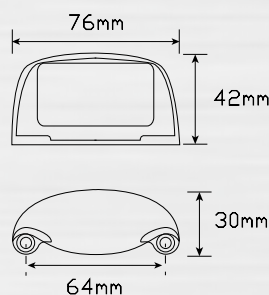

Blister Packaging



Licence Plate Lamps

- Shock, dust & water proof
- 5 Year warranty
- ADR approved



Function	Licence plate lamp		
Size	70mm x 42mm x 40mm		
Voltage	Multivolt 12-24V		
LED Qty	4		
Cable	23cm cable		
Draw	Licence		
@13.8V	0.05A		
@28V	0.04A		
Approvals	Function	Category	CRN
ECE	Licence	L00	1222

Part Number

- 41BLM** - Multivolt 12-24V, Blister single
- 41BLMB** - Multivolt 12-24V, Bulk poly bag



Non ADR approved

Function	Illumination lamp		
Size	69mm x 54mm x 40mm		
Voltage	12 Volt		
LED Qty	2		
Cable	23cm cable		
Draw	Licence		
@13.8V	0.11A		
Approvals	Function	Category	CRN
Nil	lamp	N/A	N/A

Part Number

- 65362** - 12 Volt, Bulk poly bag

Fitting Instructions

Technical Drawings

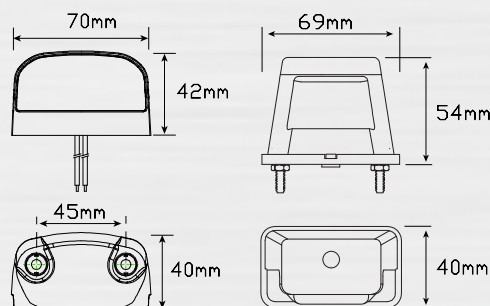

Blister Packaging



Licence Plate Lamps

- Steel housing
- Shock, dust & water proof
- 5 Year warranty



Function	Licence Plate Lamps		
Size	65mm x 30mm x 24mm		
Voltage	Multivolt 12-24V		
LED Qty	3		
Cable	14cm cable		
Draw	Licence		
@13.8V	0.02A		
@28V	0.03A		
Approvals	Function	Category	CRN
ADR	Licence	48/00	405111

Part Number

- 30BLM** - Multivolt 12-24V, Blister twin pack
- 6434BWM** - Multivolt 12-24V, Bulk poly bag

Two required, one on left and right hand side of licence plate for ADR compliance



Function	Licence Plate Lamps		
Size	65mm x 30mm x 24mm		
Voltage	Multivolt 12-24V		
LED Qty	3		
Cable	14cm cable		
Draw	Licence		
@13.8V	0.02A		
@28V	0.03A		
Approvals	Function	Category	CRN
ADR	Licence	48/00	405111

Part Number

- 30CLM** - Multivolt 12-24V, Blister twin pack
- 6434CWM** - Multivolt 12-24V, Bulk poly bag

Two required, one on left and right hand side of licence plate for ADR compliance

Fitting Instructions

Run wires through hole in flat fitting surface, ensure foam gasket is between lamp and surface, fix using screws supplied. You will require one lamp on the left and right side of the licence plate. Please refer to ADR 13/00.

Technical Drawings

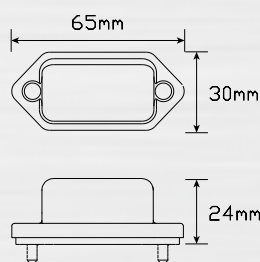

Blister Packaging



Licence Plate Lamps

- Plug in cable compatible
- Shock, dust & water proof
- 5 Year warranty



Part Number

LP1 - Multivolt 12-24V, Blister single

LP1B - Multivolt 12-24V, Bulk Boxed

Function Licence Plate Lamps
Size 375mm x 173mm x 25mm
Voltage Multivolt 12-24V
LED Qty 6
Cable 100cm cable

Draw **Licence**
@13.8V 0.11A
@28V 0.07A

Approvals **Function** **Category** **CRN**
ADR Licence 1/100 39611



LP1 with sample of licence plate fitted

Fitting Instructions

Fit onto flat surface, horizontally. Fixes into same screw pattern as standard Australian licence plates. Comes with clip that fits into back of 100, 150 or 275 lifetime warranty lamps.

Refer to ADR 13/00 for Fitting Instructions.

Technical Drawings

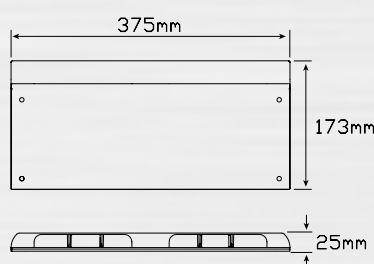

Plug/Cable

Plug on the LP1 (Below) plugs directly into the back of 100, 150 and 275 series lifetime warranty lamps or can be hard wired.



Blister Packaging



Single Function Lamps Small Vehicle/Trailer

- Small low profile design
- Shock, dust & water proof
- 5 Year warranty



Part Number

81R - 12 Volt, Blister single

81RM - Multivolt 12-24V, Blister single

Function	Stop/Tail	
Size	81mm x 81mm x 24mm	
Voltage	12 Volt or Multivolt 12-24V	
LED Qty	7	
Cable	30cm cable	

Draw	Stop	Tail
@13.8V	0.24A	0.02A
@28V	0.13A	0.03A

Approvals	Function	Category	CRN
ECE	Stop	02 R1-S1	11053
ECE	Tail	02R1-S1	11053



Part Number

81A - 12 Volt, Blister single

81AM - Multivolt 12-24V, Blister single

Function	Rear Indicator	
Size	81mm x 81mm x 24mm	
Voltage	12 Volt or Multivolt 12-24V	
LED Qty	7	
Cable	30cm cable	

Draw	Indicator
@13.8V	0.21A
@28V	0.11A

Approvals	Function	Category	CRN
ECE	Indicator	01 2a	6018



Part Number

81W - 12 Volt, Blister single

81WM - Multivolt 12-24V, Blister single

Function	Reverse	
Size	81mm x 81mm x 24mm	
Voltage	12 Volt or Multivolt 12-24V	
LED Qty	15	
Cable	30cm cable	

Draw	Reverse
@13.8V	0.32A
@28V	0.19A

Approvals	Function	Category	CRN
ECE	Reverse	00AR	1199

Fitting Instructions

Drill three holes for bolts and cable and surface mount. Please refer to ADR 13/00 for mounting instructions.

Technical Drawings

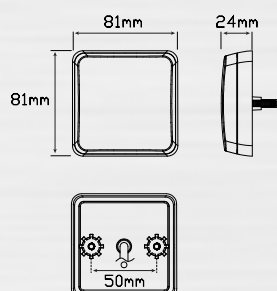

Blister Packaging



Single Function Lamps Small Vehicle/Trailer

- Individually mountable lamps
- Shock, dust & water proof
- 5 Year warranty



Part Number

- 280R12** - 12 Volt, Blister single
- 280RM** - Multivolt 12-24V, Blister single
- 280RMB** - Multivolt 12-24V, Bulk boxed

Function	Stop/Tail	
Size	91mm x 91mm x 20mm	
Voltage	12 Volt or Multivolt 12-24V	
LED Qty	12	
Cable	10cm cable	

Draw	Stop	Tail
@13.8V	0.18A	0.02A
@28V	0.11A	0.03A

Approvals	Function	Category	CRN
ADR/ECE	Stop	02 R1-S1	11544
ADR/ECE	Tail	02 R1-S1	11544



Part Number

- 280A12** - 12 Volt, Blister single
- 280AM** - Multivolt 12-24V, Blister single
- 280AMB** - Multivolt 12-24V, Bulk boxed

Function	Rear Indicator	
Size	91mm x 91mm x 20mm	
Voltage	12 Volt or Multivolt 12-24V	
LED Qty	12	
Cable	10cm cable	

Draw	Indicator
@13.8V	0.18A
@28V	0.10A

Approvals	Function	Category	CRN
ADR/ECE	Indicator	01 2a	11545



Part Number

- 280W12** - 12 Volt, Blister single
- 280WM** - Multivolt 12-24V, Blister single
- 280WMB** - Multivolt 12-24V, Bulk boxed

Function	Reverse	
Size	91mm x 91mm x 20mm	
Voltage	12 Volt or Multivolt 12-24V	
LED Qty	12	
Cable	10cm cable	

Draw	Reverse
@13.8V	0.20A
@28V	0.13A

Approvals	Function	Category	CRN
ADR/ECE	Reverse	00AR	1207

Fitting Instructions

Surface mount using rubber gasket and screws supplied. Can also be used as a replacement lamp for the 280 and 420 series lamps. Please refer to ADR 13/00 for mounting instructions.

Accessories

280B3B - Triple black bracket



Rear of lamp
rubber gasket

Technical Drawings

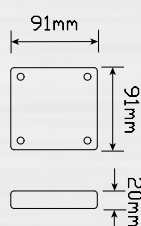

Blister Packaging



Single Function Lamps Small Vehicle/Trailer

- Slimline recessed design
- Shock, dust & water proof
- 5 Year warranty



Part Number
25R12 - 12 Volt, Bulk poly bag

Function Stop/Tail
Size 130mm x 25mm x 3mm
Voltage 12 Volt
LED Qty 17
Cable 40cm cable

Draw **Stop** **Tail**
@13.8V 0.27A 0.02A

Approvals	Function	Category	CRN
ECE	Stop	02 R1 S1	6281
ECE	Tail	02 R1 S1	6281



Part Number
25A12 - 12 Volt, Bulk poly bag

Function Rear Indicator
Size 130mm x 25mm x 3mm
Voltage 12 Volt
LED Qty 17
Cable 40cm cable

Draw **Indicator**
@13.8V 0.27A

Approvals	Function	Category	CRN
ECE	Indicator	01 2A	6021



Part Number
25W12 - 12 Volt, Bulk poly bag

Function Supplementary reverse
Size 130mm x 25mm x 3mm
Voltage 12 Volt
LED Qty 17
Cable 40cm cable

Draw **Reverse**
@13.8V 0.16A

Approvals	Function	Category	CRN
Nil	Reverse	N/A	N/A

Fitting Instructions

Mount onto flat surface horizontally and run wires through back. Push lamp into cutout (106mm x 19mm) in mounting surface, fix with screws supplied at both ends. Please refer to ADR13/00 for mounting instructions.

Technical Drawings

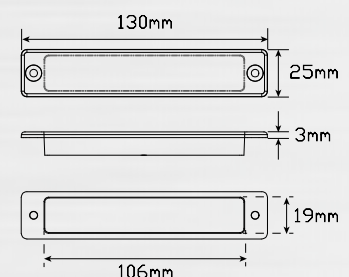

Single Function Lamps Small Vehicle/Trailer

- Original square series design
- Shock, dust & water proof
- 5 Year warranty



Part Number

- 80RB** - 12 Volt, Bulk boxed
- 80RM** - Multivolt 12-24V, Blister single
- 80RMB** - Multivolt 12-24V, Bulk boxed

Function	Stop/Tail	
Size	100mm x 100mm x 28mm	
Voltage	12 Volt and Multivolt 12-24V	
LED Qty	36	
Cable	40cm cable	

Draw	Stop	Tail
@13.8V	0.33A	0.06A
@28V	0.25A	0.04A

Approvals	Function	Category	CRN
ADR	Stop	49/00	33059
ADR	Tail	49/00	33059



Part Number

- 80AB** - 12 Volt, Bulk boxed
- 80AM** - Multivolt 12-24V, Blister single
- 80AMB** - Multivolt 12-24V, Bulk boxed

Function	Rear Indicator	
Size	100mm x 100mm x 28mm	
Voltage	12 Volt and Multivolt 12-24V	
LED Qty	36	
Cable	40cm cable	

Draw	Indicator
@13.8V	0.31A
@28V	0.22A

Approvals	Function	Category	CRN
ADR	Indicator	6/00/2A	33098



Part Number

- 80WB** - 12 Volt, Bulk boxed
- 80WM** - Multivolt 12-24V, Blister single
- 80WMB** - Multivolt 12-24V, Bulk boxed

Function	Reverse	
Size	100mm x 100mm x 28mm	
Voltage	12 Volt and Multivolt 12-24V	
LED Qty	25	
Cable	40cm cable	

Draw	Reverse
@13.8V	0.31A
@28V	0.22A

Approvals	Function	Category	CRN
ADR	Reverse	1/00	35797

Fitting Instructions

Surface mount bracket, run wires through back and clip lens into place. Please refer to ADR 13/00 for mounting instructions.

Accessories

- 80B1B - Single black bracket
- 80B2B - Dual black bracket
- 80B3B - Triple black bracket

Technical Drawings

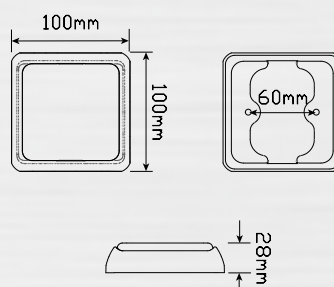

Blister Packaging



Single Function Lamps Small Vehicle/Trailer

- Recessed mount small lamp
- Shock, dust & water proof
- 5 Year warranty



Part Number

135RMG - Multivolt 12-24V, Blister single

Function Stop/Tail
Size 145mm x 48mm x 10mm
Voltage Multivolt 12-24V
LED Qty 8
Cable 40cm cable

Draw **Stop** **Tail**
@13.8V 0.11A 0.02A
@28V 0.08A 0.02A

Approvals	Function	Category	CRN
ADR	Stop	49/00	39848
ADR	Tail	49/00	39848



Part Number

135AMG - Multivolt 12-24V, Blister single

Function Rear Indicator
Size 145mm x 48mm x 10mm
Voltage Multivolt 12-24V
LED Qty 8
Cable 40cm cable

Draw **Indicator**
@13.8V 0.16A
@28V 0.06A

Approvals	Function	Category	CRN
ADR	Indicator	6/00/2A	39845



Part Number

135WMG - Multivolt 12-24V, Blister single

Function Reverse
Size 145mm x 48mm x 10mm
Voltage Multivolt 12-24V
LED Qty 8
Cable 40cm cable

Draw **Reverse**
@13.8V 0.16A
@28V 0.06A

Approvals	Function	Category	CRN
ADR	Reverse	1/00	39849

Fitting Instructions

Mount onto flat surface horizontally and run wires through back. Push lamp into cutout (106mm x 19mm) in mounting surface, fix with screws supplied at both ends. Please refer to ADR13/00 for mounting instructions.

Accessories

135G - Replacement grommet



Technical Drawings

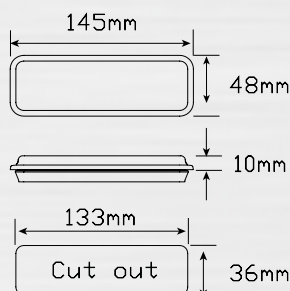

Blister Packaging



Single Function Lamps Small Vehicle/Trailer

- Surface mount small lamp
- Shock, dust & water proof
- 5 Year warranty



Part Number

135RM - Multivolt 12-24V, Blister single

Function Stop/Tail
Size 135mm x 38mm x 24mm
Voltage Multivolt 12-24V
LED Qty 8
Cable 40cm cable

Draw **Stop** **Tail**
@13.8V 0.11A 0.02A
@28V 0.08A 0.02A

Approvals	Function	Category	CRN
ADR	Stop	49/00	39848
ADR	Tail	49/00	39848



Part Number

135AM - Multivolt 12-24V, Blister single

Function Rear Indicator
Size 135mm x 38mm x 24mm
Voltage Multivolt 12-24V
LED Qty 8
Cable 40cm cable

Draw **Indicator**
@13.8V 0.16A
@28V 0.06A

Approvals	Function	Category	CRN
ADR	Indicator	6/00/2A	39845



Part Number

135WM - Multivolt 12-24V, Blister single

Function Reverse
Size 135mm x 38mm x 24mm
Voltage Multivolt 12-24V
LED Qty 8
Cable 40cm cable

Draw **Reverse**
@13.8V 0.16A
@28V 0.06A

Approvals	Function	Category	CRN
ADR	Reverse	1/00	39849

Fitting Instructions

Surface mount horizontally with screws or plugs provided, run wires through back & clip lens into place. Refer to ADR 13/00 for mounting instructions.

Accessories

135BKT-1 - Replacement bracket



Technical Drawings

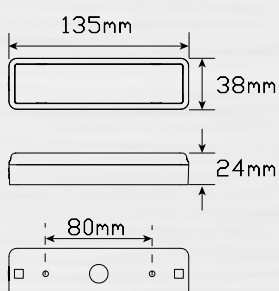

Blister Packaging



Single Function Lamps Small Vehicle/Trailer

- Budget lamps
- Shock, dust & water proof
- 5 Year warranty



Part Number
207R12 - 12 Volt, Bulk poly bag

Function	Stop/Tail		
Size	200mm x 50mm x 28mm		
Voltage	12 Volt		
LED Qty	7		
Cable	40cm cable		
Draw	Stop	Tail	
@13.8V	0.18A	0.07A	
Approvals	Function	Category	CRN
ADR	Stop	49/00	37371
ADR	Tail	49/00	37371



Part Number
207A12 - 12 Volt, Bulk poly bag

Function	Rear Indicator		
Size	200mm x 50mm x 28mm		
Voltage	12 Volt		
LED Qty	7		
Cable	40cm cable		
Draw	Indicator		
@13.8V	0.17A		
Approvals	Function	Category	CRN
ADR	Indicator	6/00/2A	37350



Part Number
207W12 - 12 Volt, Bulk poly bag

Function	Supplementary reverse		
Size	200mm x 50mm x 28mm		
Voltage	12 Volt		
LED Qty	7		
Cable	40cm cable		
Draw	Reverse		
@13.8V	0.14A		
Approvals	Function	Category	CRN
Nil	Reverse	N/A	N/A

Fitting Instructions

Surface mount bracket horizontally, run wires through back and clip lens into place. Please refer to ADR 13/00 for mounting instructions.

Technical Drawings

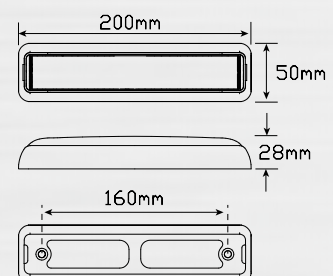

Single Function Lamps Small Vehicle/Trailer

- Original design
- Shock, dust & water proof
- 5 Year warranty



Part Number

- 200BRM** - Multivolt 12-24V, Blister single
200BRMB - Multivolt 12-24V, Bulk boxed

Function Stop/Tail
Size 200mm x 50mm x 28mm
Voltage Multivolt 12-24V
LED Qty 36
Cable 40cm cable

Draw **Stop** **Tail**
@13.8V 0.32A 0.04A
@28V 0.18A 0.04A

Approvals	Function	Category	CRN
ADR	Stop	49/00	35941
ADR	Tail	49/00	35941



Part Number

- 200BAM** - Multivolt 12-24V, Blister single
200BAMB - Multivolt 12-24V, Bulk boxed

Function Rear Indicator
Size 200mm x 50mm x 28mm
Voltage Multivolt 12-24V
LED Qty 36
Cable 40cm cable

Draw **Indicator**
@13.8V 0.39A
@28V 0.19A

Approvals	Function	Category	CRN
ADR	Indicator	6/00/2A	35795



Part Number

- 200BWM** - Multivolt 12-24V, Blister single
200BWMB - Multivolt 12-24V, Bulk boxed

Function Reverse
Size 200mm x 50mm x 28mm
Voltage Multivolt 12-24V
LED Qty 25
Cable 40cm cable

Draw **Reverse**
@13.8V 0.34A
@28V 0.18A

Approvals	Function	Category	CRN
ADR	Reverse	1/00	35796

Fitting Instructions

Surface mount bracket horizontally, run wires through back and clip lens into place. Please refer to ADR 13/00 for mounting instructions.

Accessories

200B1B - Black replacement bracket

Technical Drawings

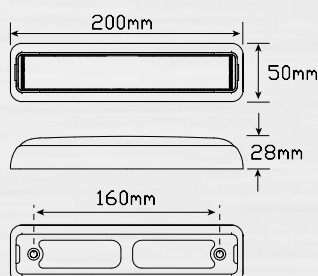

Blister Packaging



Single Function Lamps Small Vehicle/Trailer

- Recessed lamp low profile
- Shock, dust & water proof
- 5 Year warranty



Part Number

- 235R12** - 12 Volt, Blister single
235R24 - 24 Volt, Blister single

Function	Stop/Tail	
Size	237mm x 25mm x 3mm	
Voltage	12 Volt or 24 Volt	
LED Qty	10	
Cable	40cm cable	

Draw	Stop	Tail
@13.8V	0.14A	0.04A
@28V	0.13A	0.05A

Approvals	Function	Category	CRN
ADR	Stop	49/00	37678
ADR	Tail	49/00	37678



Part Number

- 235A12** - 12 Volt, Blister single
235A24 - 24 Volt, Blister single

Function	Rear Indicator	
Size	237mm x 25mm x 3mm	
Voltage	12 Volt or 24 Volt	
LED Qty	10	
Cable	40cm cable	

Draw	Indicator
@13.8V	0.16A
@28V	0.12A

Approvals	Function	Category	CRN
ADR	Indicator	6/00/2A	39092



Part Number

- 235W12E** - 12 Volt, Blister single
235W24E - 24 Volt, Blister single

Function	Supplementary Reverse	
Size	237mm x 25mm x 3mm	
Voltage	12 Volt or 24 Volt	
LED Qty	10	
Cable	40cm cable	

Draw	Reverse
@13.8V	0.12A
@28V	0.06A

Approvals	Function	Category	CRN
ECE	Reverse	TBA	TBA

Fitting Instructions

Mount onto flat surface horizontally. Push lamp and grommet into cutout (cut out 203mm x 19mm) in mounting surface, run wires through back and fix with screws supplied at both ends. Please refer to ADR13/00 for mounting instructions.

Technical Drawings

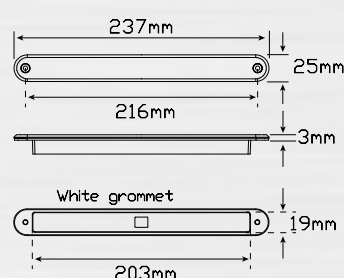

Blister Packs



Single Function Lamps Small Vehicle/Trailer

- Caravan industry low profile design
- Surface mount bracket
- 5 Year warranty



Part Number
235WR12 - 12 Volt, Blister single

Function	Stop/Tail		
Size	259mm x 46mm x 17mm		
Voltage	12 Volt		
LED Qty	10		
Cable	40cm cable		
Draw @13.8V	Stop	Tail	
	0.14A	0.04A	
Approvals	Function	Category	CRN
ADR	Stop	49/00	37678
ADR	Tail	49/00	37678



Part Number
235WA12 - 12 Volt, Blister single

Function	Rear Indicator		
Size	259mm x 46mm x 17mm		
Voltage	12 Volt		
LED Qty	10		
Cable	40cm cable		
Draw @13.8V	Indicator		
	0.16A		
Approvals	Function	Category	CRN
ADR	Indicator	6/00/2A	39092



Part Number
235WW12 - 12 Volt, Blister single

Function	Supplementary reverse		
Size	259mm x 46mm x 17mm		
Voltage	12 Volt		
LED Qty	10		
Cable	40cm cable		
Draw @13.8V	Reverse		
	0.12A		
Approvals	Function	Category	CRN
ECE	Reverse	TBA	TBA

Fitting Instructions

Surface mount onto flat surface horizontally, run wires through back and fix with screws supplied at both ends. Please refer to ADR13/00 for mounting instructions.

Technical Drawings

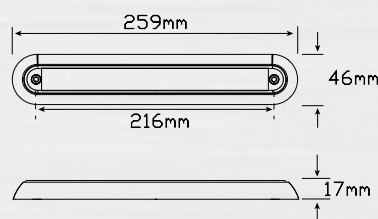

Blister Packaging



Single Function Lamps Small Vehicle/Trailer

- Slimline, low profile
- Surface mount bracket
- 5 Year warranty



Part Number
235BR12 - 12 Volt, Blister single

Function	Stop/Tail		
Size	259mm x 46mm x 17mm		
Voltage	12 Volt		
LED Qty	10		
Cable	40cm cable		
Draw @13.8V	Stop	Tail	
	0.14A	0.04A	
Approvals	Function	Category	CRN
ADR	Stop	49/00	37678
ADR	Tail	49/00	37678



Part Number
235BA12 - 12 Volt, Blister single

Function	Rear Indicator		
Size	259mm x 46mm x 17mm		
Voltage	12 Volt		
LED Qty	10		
Cable	40cm cable		
Draw @13.8V	Indicator		
	0.16A		
Approvals	Function	Category	CRN
ADR	Indicator	6/00/2A	39092

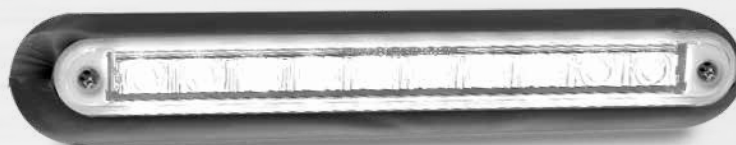

Part Number
235BW12 - 12 Volt, Blister single

Function	Supplementary reverse		
Size	259mm x 46mm x 17mm		
Voltage	12 Volt		
LED Qty	10		
Cable	40cm cable		
Draw @13.8V	Reverse		
	0.12A		
Approvals	Function	Category	CRN
ECE	Reverse	TBA	TBA

Fitting Instructions

Surface mount onto flat surface horizontally, run wires through back and fix with screws supplied at both ends. Please refer to ADR13/00 for mounting instructions.

Technical Drawings

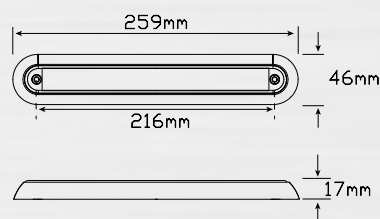

Blister Packaging



Single Function Lamps Medium Vehicle/Trailer

- Original square series design
- Shock, dust & water proof
- 5 Year warranty



Part Number

- 100RM** - Multivolt 12-24V, Blister single
- 100RMB** - Multivolt 12-24V, Bulk boxed

Function	Stop/Tail	
Size	122mm x 122mm x 31mm	
Voltage	Multivolt 12-24V	
LED Qty	49	
Cable	40cm cable	

Draw	Stop	Tail
@13.8V	0.38A	0.04A
@28V	0.24A	0.04A

Approvals	Function	Category	CRN
ADR	Stop	49/00	33402
ADR	Tail	49/00	33402



Part Number

- 100AM** - Multivolt 12-24V, Blister single
- 100AMB** - Multivolt 12-24V, Bulk boxed

Function	Rear Indicator	
Size	122mm x 122mm x 31mm	
Voltage	Multivolt 12-24V	
LED Qty	49	
Cable	40cm cable	

Draw	Indicator
@13.8V	0.38A
@28V	0.23A

Approvals	Function	Category	CRN
ADR	Indicator	6/00/2A	33156



Part Number

- 100WM** - Multivolt 12-24V, Blister single
- 100WMB** - Multivolt 12-24V, Bulk boxed

Function	Reverse	
Size	122mm x 122mm x 31mm	
Voltage	Multivolt 12-24V	
LED Qty	25	
Cable	40cm cable	

Draw	Reverse
@13.8V	0.31A
@28V	0.17A

Approvals	Function	Category	CRN
ADR	Reverse	1/00	35793

Fitting Instructions

Surface mount bracket, run wires through back and clip lens into place. Please refer to ADR 13/00 for mounting instructions.

Technical Drawings

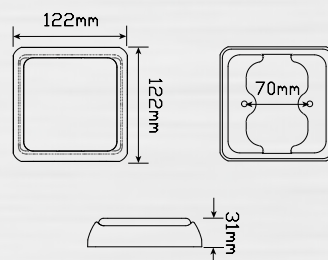

Blister Packaging



Single Function Lamps Medium Vehicle/Trailer

- Replaceable lens design
- Shock, dust & water proof
- 5 Year warranty



Part Number
200BRRM - Multivolt 12-24V, Blister single

Function	Stop/Tail		
Size	200mm x 92mm x 28mm		
Voltage	Multivolt 12-24V		
LED Qty	72		
Cable	40cm cable		
Draw	Stop	Tail	
@13.8V	0.64A	0.04A	
@28V	0.36A	0.08A	
Approvals	Function	Category	CRN
ADR	Stop	49/00	35941
ADR	Tail	49/00	35941



Part Number
200BAAM - Multivolt 12-24V, Blister single

Function	Rear Indicator		
Size	200mm x 92mm x 28mm		
Voltage	Multivolt 12-24V		
LED Qty	72		
Cable	40cm cable		
Draw	Indicator		
@13.8V	0.68A		
@28V	0.38A		
Approvals	Function	Category	CRN
ADR	Indicator	6/00/2A	35795

Fitting Instructions

Surface mount bracket onto flat surface horizontally with bolts provided, run wires through back and clip lens into place. Please refer to ADR 13/00 for mounting instructions

Accessories

- 200BRMB - Stop/tail
- 200BAMB - Indicator

Technical Drawings

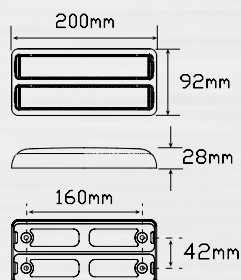

Blister Packaging



Single Function Lamps Medium Vehicle/Trailer

- Designed with rear reflector
- Shock, dust & water proof
- 5 Year warranty



Part Number

- 130RM** - Multivolt 12-24V, Reflector, Blister single
130RMB - Multivolt 12-24V, Reflector, Bulk poly bag

Function	Stop/Tail and Stop/tail with reflector		
Size	134mm x 86mm x 16mm		
Voltage	Multivolt 12-24V		
LED Qty	14		
Cable	use part no. 53102		
Draw	Stop	Tail	
@13.8V	0.23A	0.03A	
@28V	0.12A	0.04A	
Approvals	Function	Category	CRN
ADR	Stop/Tail	49/00	36844
	Reflector	47/00	38102



Part Number

- 130AM** - Multivolt 12-24V, Blister single
130AMB - Multivolt 12-24V, Bulk poly bag

Function	Rear Indicator		
Size	134mm x 86mm x 16mm		
Voltage	Multivolt 12-24V		
LED Qty	14		
Cable	use part no. 53102		
Draw	Indicator		
@13.8V	0.20A		
@28V	0.14A		
Approvals	Function	Category	CRN
ADR	Indicator	6/00/2A	36843



Part Number

- 130WM** - Multivolt 12-24V, Blister single

Function	Reverse		
Size	134mm x 86mm x 16mm		
Voltage	Multivolt 12-24V		
LED Qty	32		
Cable	use part no. 53102		
Draw	Reverse		
@13.8V	0.15A		
@28V	0.08A		
Approvals	Function	Category	CRN
ADR	Reverse	1/00	36845

Fitting Instructions

Retro fit lamps. If new installation, fit grommet or flange into cutout (cut out 139 x 91mm), plug wire into lamp and run through back then push into grommet/flange. Please refer to ADR 13/00 for mounting instructions.

Accessories

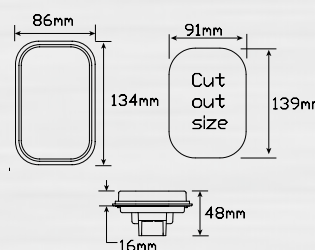

Blister Packs



Single Function Lamps Medium Vehicle/Trailer

- Horizontal or vertical mount
- Shock, dust & water proof
- 5 Year warranty



Part Number
131RM - Multivolt 12-24V, Blister single

Function Stop/Tail
Size 134mm x 87mm x 12mm
Voltage Multivolt 12-24V
LED Qty 16
Cable 40cm Spade terminals

Draw **Stop** **Tail**
@13.8V 0.22A 0.03A
@28V 0.12A 0.03A

Approvals **Function** **Category** **CRN**
ADR Stop/Tail 49/00 TBA



Part Number
131AM - Multivolt 12-24V, Blister single

Function Rear Indicator
Size 134mm x 87mm x 12mm
Voltage Multivolt 12-24V
LED Qty 16
Cable 40cm Spade terminals

Draw **Indicator**
@13.8V 0.19A
@28V 0.11A

Approvals **Function** **Category** **CRN**
ADR Indicator 6/00/2A TBA



Part Number
131WM - Multivolt 12-24V, Blister single

Function Reverse
Size 134mm x 87mm x 12mm
Voltage Multivolt 12-24V
LED Qty 16
Cable 40cm Spade terminals

Draw **Reverse**
@13.8V 0.17A
@28V 0.10A

Approvals **Function** **Category** **CRN**
ADR Reverse 1/00 TBA

Fitting Instructions

Retro fit to existing rectangle lamps. If new installation, fit grommet or flange into cutout (cut out 139mm x 91mm), run wires through back then push into grommet/flange. Please refer to ADR 13/00 for mounting instructions.

Accessories



Technical Drawings

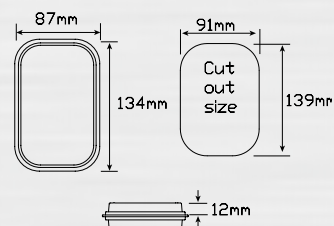

Blister Pack



Single Function Lamps Medium Vehicle/Trailer

- Economical design
- Shock, dust & water proof
- 5 Year warranty



Part Number

5940RM - Multivolt 12-24V, Blister single
5940RMB - Multivolt 12-24V, Bulk poly bag

Function	Stop/Tail		
Size	134mm x 86mm x 12mm		
Voltage	Multivolt 12-24V		
LED Qty	15		
Plug	use part no. 53102		
Draw	Stop	Tail	
@13.8V	0.20A	0.02A	
@28V	0.14A	0.04A	
Approvals	Function	Category	CRN
ADR	Stop/Tail	49/00	46832



Part Number

5940AM - Multivolt 12-24V, Blister single
5940AMB - Multivolt 12-24V, Bulk poly bag

Function	Rear Indicator		
Size	134mm x 86mm x 12mm		
Voltage	Multivolt 12-24V		
LED Qty	15		
Plug	use part no. 53102		
Draw	Indicator		
@13.8V	0.19A		
@28V	0.13A		
Approvals	Function	Category	CRN
ADR	Indicator	6/00/2A	46826



Part Number

5940W - 12 Volt, Bulk poly bag

Function	Reverse		
Size	134mm x 86mm x 12mm		
Voltage	12 Volt		
LED Qty	15		
Plug	use part no. 53102		
Draw	Reverse		
@13.8V	0.17A		
@28V	0.10A		
Approvals	Function	Category	CRN
Nil	Reverse	N/A	N/A

Fitting Instructions

Retro fit lamps. If new installation, fit grommet or flange into cutout (cut out 139 x 91mm), plug wire into lamp and run through back then push into grommet/flange. Please refer to ADR 13/00 for mounting instructions.

Accessories

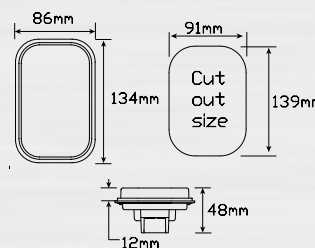

Blister Packs



Single Function Lamps Medium Vehicle/Trailer

- Popular high brightness design
- Shock, dust & water proof
- 5 Year warranty



Part Number
5590RM - Multivolt 12-24V, Bulk poly bag

Function	Stop/Tail	
Size	134mm x 86mm x 12mm	
Voltage	Multivolt 12-24V	
LED Qty	40	
Plug	use part no. 53102	

Draw	Stop	Tail
@13.8V	0.13A	0.06A
@28V	0.22A	0.04A

Approvals	Function	Category	CRN
ADR	Stop/Tail	49/00	N/A



Part Number
5590AM - Multivolt 12-24V, Bulk poly bag

Function	Rear Indicator	
Size	134mm x 86mm x 12mm	
Voltage	Multivolt 12-24V	
LED Qty	40	
Plug	use part no. 53102	

Draw	Indicator
@13.8V	0.28A
@28V	0.20A

Approvals	Function	Category	CRN
ADR	Indicator	6/00/2A	N/A



Part Number
5590WM - Multivolt 12-24V, Bulk poly bag

Function	Reverse	
Size	134mm x 86mm x 12mm	
Voltage	Multivolt 12-24V	
LED Qty	36	
Plug	use part no. 53102	

Draw	Reverse
@13.8V	0.13A
@28V	0.25A

Approvals	Function	Category	CRN
Nil	Reverse	N/A	N/A

Fitting Instructions

Retro fit to existing rectangle lamps. If new installation, fit grommet or flange into cutout (cut out 139mm x 91mm), plug wire into lamp then push into grommet/flange. Please refer to ADR 13/00 for mounting instructions.

Accessories

- 59401B - Black flange
- 59401C - Chrome flange
- 59101 - Rubber grommet
- 53102 - Plug

Accessories



Technical Drawings

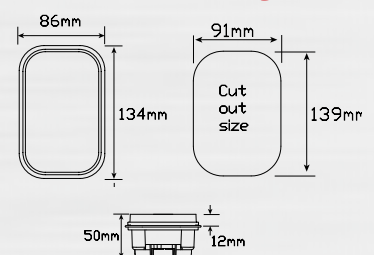

Single Function Lamps Medium Vehicle/Trailer

- Popular round series lamps
- Shock, dust & water proof
- 5 Year warranty



Part Number

- 110RM** - Multivolt 12-24V, Blister single
- 110RMB** - Multivolt 12-24V, Bulk poly bag

Function	Stop/Tail		
Size	109mm round x 12mm		
Voltage	Multivolt 12-24V		
LED Qty	27		
Plug	use part no. 53102		
Draw	Stop	Tail	
@13.8V	0.23A	0.08A	
@28V	0.14A	0.02A	
Approvals	Function	Category	CRN
ADR	Stop/Tail	49/00	35299



Part Number

- 110AM** - Multivolt 12-24V, Blister single
- 110AMB** - Multivolt 12-24V, Bulk poly bag

Function	Rear Indicator		
Size	109mm round x 12mm		
Voltage	Multivolt 12-24V		
LED Qty	27		
Plug	use part no. 53102		
Draw	Indicator		
@13.8V	0.16A		
@28V	0.13A		
Approvals	Function	Category	CRN
ADR	Indicator	6/00/2A	35298



Part Number

- 110WM** - Multivolt 12-24V, Blister single
- 110WMB** - Multivolt 12-24V, Bulk poly bag

Function	Reverse		
Size	109mm round x 12mm		
Voltage	Multivolt 12-24V		
LED Qty	27		
Plug	use part no. 53102		
Draw	Reverse		
@13.8V	0.21A		
@28V	0.15A		
Approvals	Function	Category	CRN
ADR	Reverse	1/00	36102

Fitting Instructions

Retro fit to existing 4 inch lamps. If new installation fit grommet or flange into cutout (Cut out 115mm round) plug wire into lamp and run through back then push into grommet/flange. Please refer to ADR 13/00 for mounting instructions.

Accessories



Technical Drawings

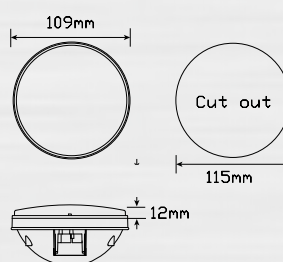

Blister Packaging



Single Function Lamps Medium Vehicle/Trailer

- Low profile recess model
- Shock, dust & water proof
- 5 Year warranty



Function	Stop/Tail		
Size	130mm round x 12mm		
Voltage	12 Volt and Multivolt 12-24V		
LED Qty	20		
Cable	40cm Spade terminals		
Draw	Stop	Tail	
@13.8V	0.31A	0.04A	
@28V	0.19A	0.04A	
Approvals	Function	Category	CRN
ADR	Stop/Tail	49/00	42963

Part Number

- 102R** - 12 Volt, Bulk poly bag
- 102RM** - Multivolt 12-24V, Blister single



Function	Rear Indicator		
Size	130mm round x 12mm		
Voltage	12 Volt and Multivolt 12-24V		
LED Qty	20		
Cable	40cm Spade terminals		
Draw	Indicator		
@13.8V	0.29A		
@28V	0.20A		
Approvals	Function	Category	CRN
ADR	Indicator	6/00/2A	42832

Part Number

- 102A** - 12 Volt, Bulk poly bag
- 102AM** - Multivolt 12-24V, Blister single



Function	Reverse		
Size	130mm round x 12mm		
Voltage	12 Volt and Multivolt 12-24V		
LED Qty	20		
Cable	40cm Spade terminals		
Draw	Reverse		
@13.8V	0.15A		
@28V	0.11A		
Approvals	Function	Category	CRN
ADR	Reverse	1/00	42826

Part Number

- 102W** - 12 Volt, Bulk poly bag
- 102WM** - Multivolt 12-24V, Blister single

Fitting Instructions

Fit into cutout (cutout 104mm round) using stick on gasket between lamp and fitting surface, run wires at back. Please refer to ADR 13/00 for mounting instructions.

Accessories

102B3B - Triple black bracket.



102W3B - Triple white bracket.



Technical Drawings

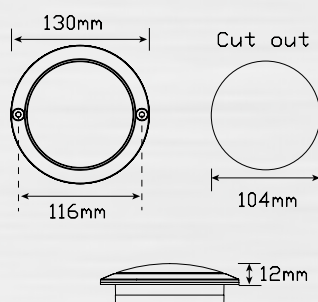

Blister Packaging



Single Function Lamps Medium Vehicle/Trailer

- High brightness American design
- Shock, dust & water proof
- 5 Year warranty



Part Number
5575R - 12 Volt, Bulk poly bag

Function Stop/Tail
Size 109mm round x 12mm
Voltage 12 Volt
LED Qty 48
Plug use part no. 53102

Draw **Stop** **Tail**
 @13.8V 0.27A 0.07A

Approvals	Function	Category	CRN
DOT/SAE	Stop/Tail	N/A	N/A



Part Number
5575A - 12 Volt, Bulk poly bag

Function Rear Indicator
Size 109mm round x 12mm
Voltage 12 Volt
LED Qty 48
Plug use part no. 53102

Draw **Indicator**
 @13.8V 0.42A

Approvals	Function	Category	CRN
DOT/SAE	Indicator	N/A	N/A



Part Number
5575W - 12 Volt, Bulk poly bag

Function Reverse
Size 109mm round x 12mm
Voltage 12 Volt
LED Qty 48
Plug use part no. 53102

Draw **Reverse**
 @13.8V 0.66A

Approvals	Function	Category	CRN
DOT/SAE	Reverse	N/A	N/A

Fitting Instructions

Retro fit to existing fittings if new installation fit grommet or flange into cutout (cut out 115mm diameter) plug wire into lamp and run through back then push into grommet/flange.

Accessories



Black Bracket



Chrome Bracket



Grommet



53102 - Plug

Technical Drawings

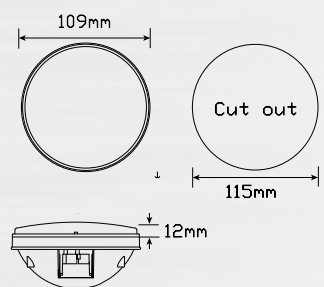

Single Function Lamps Medium Vehicle/Trailer

- High brightness American design
- Shock, dust & water proof
- 5 Year warranty



Part Number
5570R - 12 Volt, Bulk poly bag

Function Stop/Tail
Size 109mm round x 12mm
Voltage 12 Volt
LED Qty 60
Plug use part no. 53102

Draw @13.8V **Stop** **Tail**
 0.42A 0.02A

Approvals DOT/SAE	Function	Category	CRN
	Stop/Tail	N/A	N/A



Part Number
5570A - 12 Volt, Bulk poly bag

Function Rear Indicator
Size 109mm round x 12mm
Voltage 12 Volt
LED Qty 60
Plug use part no. 53102

Draw @13.8V **Indicator**
 0.42A

Approvals DOT/SAE	Function	Category	CRN
	Indicator	N/A	N/A



Part Number
5570W - 12 Volt, Bulk poly bag

Function Reverse
Size 109mm round x 12mm
Voltage 12 Volt
LED Qty 60
Plug use part no. 53102

Draw @13.8V **Reverse**
 0.78A

Approvals DOT/SAE	Function	Category	CRN
	Reverse	N/A	N/A

Fitting Instructions

Retro fit to existing fittings if new installation fit grommet or flange into cutout (cut out 115mm diameter) plug wire into lamp and run through back then push into grommet/flange.

Accessories



Black Bracket



Chrome Bracket



Grommet



53102 - Plug

Technical Drawings

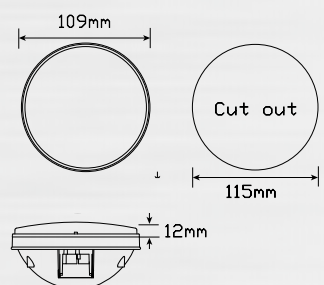

Single Function Lamps Medium Vehicle/Trailer

- American style design
- Shock, dust & water proof
- 5 Year warranty



Part Number

5513R - 12 Volt, Bulk poly bag

Function	Stop/Tail		
Size	140mm round x 10mm		
Voltage	12 Volt		
LED Qty	10		
Plug	use part no. 55062		
Draw @13.8V	Stop	Tail	
	0.27A	0.07A	
Approvals DOT/SAE	Function	Category	CRN
	Stop/Tail	N/A	N/A



Part Number

5513A - 12 Volt, Bulk poly bag

Function	Rear Indicator		
Size	140mm round x 10mm		
Voltage	12 Volt		
LED Qty	10		
Plug	use part no. 55062		
Draw @13.8V	Indicator		
	0.26A		
Approvals DOT/SAE	Function	Category	CRN
	Indicator	N/A	N/A



Part Number

5513W - 12 Volt, Bulk poly bag

Function	Reverse		
Size	140mm round x 10mm		
Voltage	12 Volt		
LED Qty	10		
Plug	use part no. 55062		
Draw @13.8V	Reverse		
	0.13A		
Approvals DOT/SAE	Function	Category	CRN
	Reverse	N/A	N/A

Fitting Instructions

Retro fit to existing fittings, wire into existing loom and fix with screws through three fixing points.

Accessories

55062 - Plug



Technical Drawings

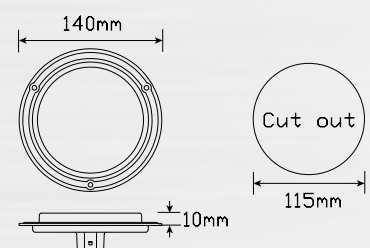

Single Function Lamps Medium Vehicle/Trailer

- American style design
- Shock, dust & water proof
- 5 Year warranty



Part Number
5523R - 12 Volt, Bulk poly bag

Function	Stop/Tail	
Size	109mm round x 10mm	
Voltage	12 Volt	
LED Qty	10	
Plug	use part no. 55062	

Draw	Stop	Tail
@13.8V	0.27A	0.07A

Approvals	Function	Category	CRN
DOT/SAE	Stop/Tail	N/A	N/A



Part Number
5523A - 12 Volt, Bulk poly bag

Function	Rear Indicator
Size	109mm round x 10mm
Voltage	12 Volt
LED Qty	10
Plug	use part no. 55062

Draw	Indicator
@13.8V	0.08A

Approvals	Function	Category	CRN
DOT/SAE	Indicator	N/A	N/A



Part Number
5525W - 12 Volt, Bulk poly bag

Function	Reverse
Size	109mm round x 10mm
Voltage	12 Volt
LED Qty	10
Plug	use part no. 55062

Draw	Reverse
@13.8V	0.23A

Approvals	Function	Category	CRN
DOT/SAE	Reverse	N/A	N/A

Fitting Instructions

Retro fit to existing fittings if new installation fit grommet or flange into cutout (cut out 115mm diameter) plug wire into lamp and run through back then push into grommet/flange.

Accessories



Black Bracket



Chrome Bracket

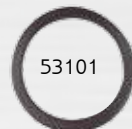

Grommet



55062 - Plug

Technical Drawings

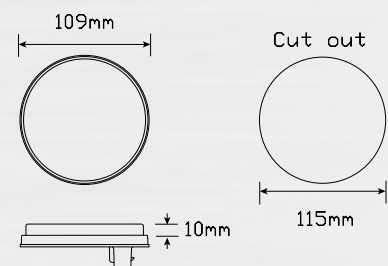

Single Function Lamps Medium Vehicle/Trailer

- American style design
- Shock, dust & water proof
- 5 Year warranty



Part Number
5543FR - 12 Volt, Bulk poly bag

Function	Stop/Tail with reflector	
Size	139mm round x 3mm	
Voltage	12 Volt	
LED Qty	10	
Cable	26cm cable with plug	

Draw	Stop	Tail
@13.8V	0.27A	0.07A

Approvals	Function	Category	CRN
DOT/SAE	Stop/Tail	N/A	N/A



Part Number
5543FA - 12 Volt, Bulk poly bag

Function	Rear Indicator with reflector	
Size	139mm round x 3mm	
Voltage	12 Volt	
LED Qty	10	
Cable	26cm cable with plug	

Draw	Indicator
@13.8V	0.26A

Approvals	Function	Category	CRN
DOT/SAE	Indicator	N/A	N/A



Part Number
5543FW - 12 Volt, Bulk poly bag

Function	Reverse with reflector	
Size	139mm round x 3mm	
Voltage	12 Volt	
LED Qty	10	
Cable	26cm cable with plug	

Draw	Reverse
@13.8V	0.26A

Approvals	Function	Category	CRN
DOT/SAE	Reverse	N/A	N/A

Fitting Instructions

Retro fit to existing fittings if new installation fit grommet or flange into cutout (cut out 115mm diameter) plug wire into lamp and run through back then push into grommet/flange.

Technical Drawings

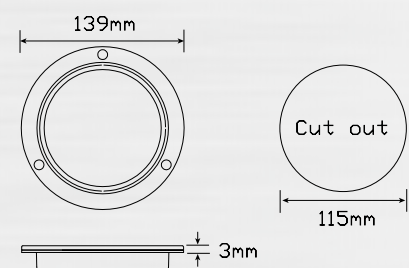

Single Function Lamps Medium Vehicle/Trailer

- American style design
- Shock, dust & water proof
- 5 Year warranty



Part Number
5503RM - Multivolt 12-24V, Bulk poly bag

Function	Stop/Tail		
Size	164mm x 58mm x 39mm		
Voltage	Multivolt 12-24V		
LED Qty	10		
Plug	Use Part no. 55062		
Draw @13.8V	Stop	Tail	
	0.30A	0.02A	
Approvals DOT/SAE	Function	Category	CRN
	Stop/Tail	N/A	N/A



Part Number
5503AM - Multivolt 12-24V, Bulk poly bag

Function	Rear Indicator		
Size	164mm x 58mm x 39mm		
Voltage	Multivolt 12-24V		
LED Qty	10		
Plug	Use Part no. 55062		
Draw @13.8V	Indicator		
	0.13A		
Approvals DOT/SAE	Function	Category	CRN
	Indicator	N/A	N/A



Part Number
5505W - 12 Volt, Bulk poly bag

Function	Reverse		
Size	164mm x 58mm x 39mm		
Voltage	12 Volt		
LED Qty	10		
Plug	Use Part no. 55062		
Draw @13.8V	Reverse		
	0.13A		
Approvals DOT/SAE	Function	Category	CRN
	Reverse	N/A	N/A

Fitting Instructions

Fit grommet into cutout in mounting surface, run wire through back of grommet and plug into back of lamp, push lamp into grommet.

Accessories

- 54101 - Grommet
- 55062 - Plug

Accessories



Technical Drawings

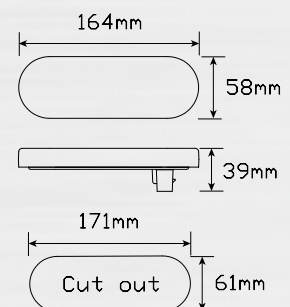

Single Function Lamps Medium Vehicle/Trailer

- American style design
- Shock, dust & water proof
- 5 Year warranty



Part Number
5533R - 12 Volt, Bulk poly bag

Function	Stop/Tail		
Size	192mm x 83mm x 39mm		
Voltage	12 Volt		
LED Qty	10		
Plug	Use Part no. 55062		
Draw @13.8V	Stop	Tail	
	0.30A	0.02A	
Approvals DOT/SAE	Function	Category	CRN
	Stop/Tail	N/A	N/A



Part Number
5533A - 12 Volt, Bulk poly bag

Function	Rear Indicator		
Size	192mm x 83mm x 39mm		
Voltage	12 Volt		
LED Qty	10		
Plug	Use Part no. 55062		
Draw @13.8V	Indicator		
	0.26A		
Approvals DOT/SAE	Function	Category	CRN
	Indicator	N/A	N/A



Part Number
5535W - 12 Volt, Bulk poly bag

Function	Reverse		
Size	192mm x 83mm x 39mm		
Voltage	12 Volt		
LED Qty	10		
Plug	Use Part no. 55062		
Draw @13.8V	Reverse		
	0.15A		
Approvals DOT/SAE	Function	Category	CRN
	Reverse	N/A	N/A

Fitting Instructions

Fit lamp onto mounting surface with 4 screw points, run wire through back and plug into back of lamp.

Accessories
55062 - Plug



Technical Drawings

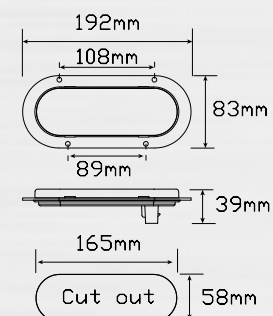

Single Function Lamps Medium Vehicle/Trailer

- Recessed lamp low profile
- Shock, dust & water proof
- 5 Year warranty



Part Number

- 380R12** - 12 Volt, Blister single
380R24 - 24 Volt, Blister single

Function	Stop/Tail	
Size	382mm x 25mm x 3mm	
Voltage	12 Volt or 24 Volt	
LED Qty	18	
Cable	40cm cable	

Draw	Stop	Tail
@13.8V	0.16A	0.04A
@28V	0.12A	0.01A

Approvals	Function	Category	CRN
ADR	Stop	49/00	39473
ADR	Tail	49/00	39473



Part Number

- 380A12** - 12 Volt, Blister single
380A24 - 24 Volt, Blister single

Function	Rear Indicator	
Size	382mm x 25mm x 3mm	
Voltage	12 Volt or 24 Volt	
LED Qty	18	
Cable	40cm cable	

Draw	Indicator
@13.8V	0.18A
@28V	0.10A

Approvals	Function	Category	CRN
ADR	Indicator	6/00/2A	39470



Part Number

- 380W12** - 12 Volt, Blister single
380W24 - 24 Volt, Blister single

Function	Supplementary reverse	
Size	382mm x 25mm x 3mm	
Voltage	12 Volt or 24 Volt	
LED Qty	18	
Cable	40cm cable	

Draw	Reverse
@13.8V	0.14A
@28V	0.09A

Approvals	Function	Category	CRN
Nil	Supp Rev	N/A	N/A

Fitting Instructions

Mount onto flat surface horizontally. Push lamp and grommet into cutout (cut out 348mm x 19mm) in mounting surface, run wires through back and fix with screws supplied at both ends. Please refer to ADR13/00 for mounting instructions.

Technical Drawings

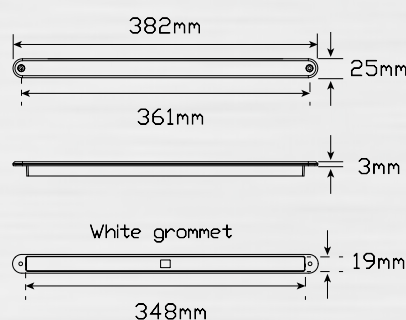

Blister Packs



Single Function Lamps Large Vehicle/Trailer

- Original square series design
- Shock, dust & water proof
- 5 Year warranty



Part Number

125RM - Multivolt 12-24V, Blister single
125RMB - Multivolt 12-24V, Bulk poly bag

Function	Stop/Tail		
Size	147mm x 147mm x 31mm		
Voltage	Multivolt 12-24V		
LED Qty	64		
Cable	40cm cable		
Draw	Stop	Tail	
@13.8V	0.42A	0.04A	
@28V	0.26A	0.06A	
Approvals	Function	Category	CRN
ADR	Stop	49/00	33403
ADR	Tail	49/00	33403



Part Number

125AM - Multivolt 12-24V, Blister single
125AMB - Multivolt 12-24V, Bulk poly bag

Function	Rear Indicator		
Size	147mm x 147mm x 31mm		
Voltage	Multivolt 12-24V		
LED Qty	64		
Cable	40cm cable		
Draw	Indicator		
@13.8V	0.43A		
@28V	0.25A		
Approvals	Function	Category	CRN
ADR	Indicator	6/00/2A	33165



Part Number

125WM - Multivolt 12-24V, Blister single
125WMB - Multivolt 12-24V, Bulk poly bag

Function	Reverse		
Size	147mm x 147mm x 31mm		
Voltage	Multivolt 12-24V		
LED Qty	25		
Cable	40cm cable		
Draw	Reverse		
@13.8V	0.36A		
@28V	0.18A		
Approvals	Function	Category	CRN
ADR	Reverse	1/00	35794

Fitting Instructions

Surface mount bracket, run wires through back and clip lens into place. Please refer to ADR 13/00 for mounting instructions.

Technical Drawings

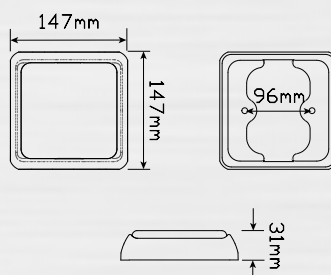

Blister Packaging



Single Function Lamps Medium Vehicle/Trailer

- Replaceable lens design
- Shock, dust & water proof
- 5 Year warranty

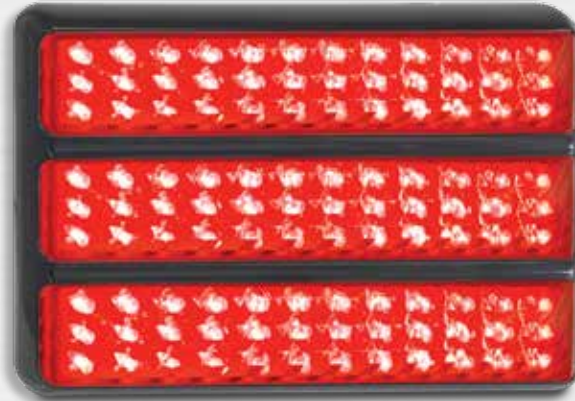

Function	Stop/Tail		
Size	200mm x 134mm x 28mm		
Voltage	Multivolt 12-24V		
LED Qty	108		
Cable	40cm cable		
Draw	Stop	Tail	
@13.8V	0.96A	0.12A	
@28V	0.54A	0.12A	
Approvals	Function	Category	CRN
ADR	Stop	49/00	35941
ADR	Tail	49/00	35941

Part Number
200BRRRM - Multivolt 12-24V, Blister single

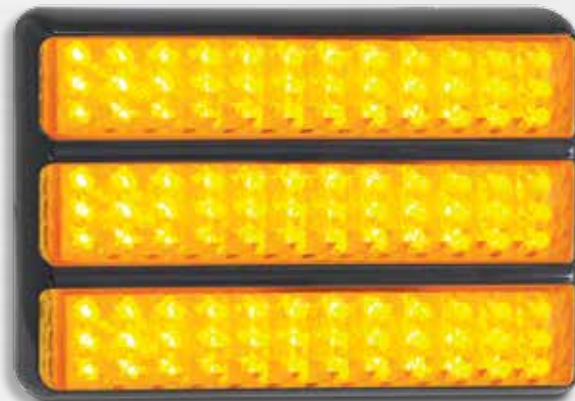

Function	Rear Indicator		
Size	200mm x 134mm x 28mm		
Voltage	Multivolt 12-24V		
LED Qty	108		
Cable	40cm cable		
Draw	Indicator		
@13.8V	1.02A		
@28V	0.57A		
Approvals	Function	Category	CRN
ADR	Indicator	6/00/2A	35795

Part Number
200BAAAM - Multivolt 12-24V, Blister single

Fitting Instructions

Surface mount bracket onto flat surface horizontally with bolts provided, run wires through back and clip lens into place. Please refer to ADR 13/00 for mounting instructions.

Technical Drawings

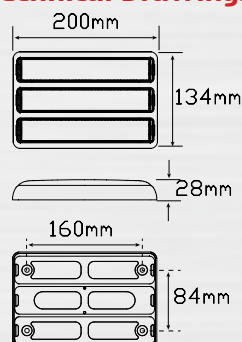

Blister Packaging



Single Function Lamps Large Vehicle/Trailer

- American style design
- Shock, dust & water proof
- 5 Year warranty



Function Stop/Tail
Size 177mm round x 25mm
Voltage 12 Volt
LED Qty 16
Cable 20cm cable

Draw **Stop** **Tail**
@13.8V 0.30A 0.07A

Approvals **Function** **Category** **CRN**
DOT/SAE Stop/Tail N/A N/A

Part Number

5585R - 12 Volt, Bulk poly bag



Function Rear Indicator
Size 177mm round x 25mm
Voltage 12 Volt
LED Qty 16
Cable 20cm cable

Draw **Indicator**
@13.8V 0.33A

Approvals **Function** **Category** **CRN**
DOT/SAE Indicator N/A N/A

Part Number

5585A - 12 Volt, Bulk poly bag



Function Reverse
Size 177mm round x 25mm
Voltage 12 Volt
LED Qty 16
Cable 20cm cable

Draw **Reverse**
@13.8V 0.31A

Approvals **Function** **Category** **CRN**
DOT/SAE Reverse N/A N/A

Part Number

5585W - 12 Volt, Bulk poly bag

Fitting Instructions

Retro fit to existing fittings, wire into existing loom and fix with screws through four fixing points.

Technical Drawings

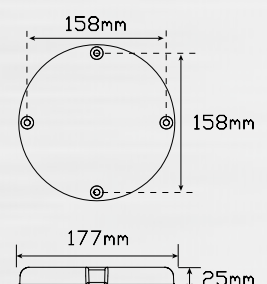

Single Function Lamps Large Vehicle/Trailer

- Replacement for 460 Series
- Shock, dust & water proof
- 5 Year warranty



Part Number
460RMB - Multivolt 12-24V, Bulk poly bag

Function	Stop/Tail	
Size	148mm x 122mm x 30mm	
Voltage	Multivolt 12-24V	
LED Qty	16	
Cable	10cm cable	

Draw	Stop	Tail
@13.8V	0.30A	0.02A
@28V	0.17A	0.04A

Approvals	Function	Category	CRN
ECE	Stop/Tail	02 R1-S1	11293
ECE	Reflector	02 1A	1472



Part Number
460AMB - Multivolt 12-24V, Bulk poly bag

Function	Rear Indicator	
Size	148mm x 122mm x 30mm	
Voltage	Multivolt 12-24V	
LED Qty	16	
Cable	10cm cable	

Draw	Indicator
@13.8V	0.32A
@28V	0.18A

Approvals	Function	Category	CRN
ECE	Indicator	01 2a	6205
ECE	Reflector	02 1A	1472



Part Number
460WMB - Multivolt 12-24V, Bulk poly bag

Function	Reverse	
Size	148mm x 122mm x 30mm	
Voltage	Multivolt 12-24V	
LED Qty	16	
Cable	10cm cable	

Draw	Reverse
@13.8V	0.19A
@28V	0.12A

Approvals	Function	Category	CRN
ECE	Reverse	00 AR	1208
ECE	Reflector	02 1A	1472

Fitting Instructions

Can also be used as a replacement lamp for the 460 series lamps. Please refer to ADR 13/00 for mounting instructions.

Accessories

460B3B - Triple black bracket

Technical Drawings

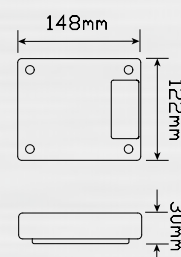

Single Function Lamps Large Vehicle/Trailer

- Replacement for Jumbo
- Shock, dust & water proof
- 5 Year warranty



Part Number

J3RM - Multivolt 12-24V, Bulk poly bag

Function	Stop/Tail	
Size	190mm x 122mm x 30mm	
Voltage	Multivolt 12-24V	
LED Qty	24	
Cable	10cm cable	

Draw	Stop	Tail
@13.8V	0.47A	0.04A
@28V	0.27A	0.03A

Approvals	Function	Category	CRN
ADR	Stop	49/00	42965
ADR	Tail	49/00	42964
ADR	Reflector	47/00	42966



Part Number

J3AM - Multivolt 12-24V, Bulk poly bag

Function	Rear Indicator	
Size	190mm x 122mm x 30mm	
Voltage	Multivolt 12-24V	
LED Qty	24	
Cable	10cm cable	

Draw	Indicator
@13.8V	0.42A
@28V	0.28A

Approvals	Function	Category	CRN
ADR	Indicator	6/00/2A	42964
ADR	Reflector	47/00	42966

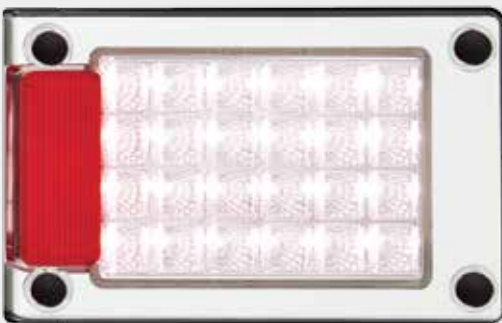

Part Number

J3WM - Multivolt 12-24V, Bulk poly bag

Function	Reverse	
Size	190mm x 122mm x 30mm	
Voltage	Multivolt 12-24V	
LED Qty	24	
Cable	10cm cable	

Draw	Reverse
@13.8V	0.18A
@28V	0.117A

Approvals	Function	Category	CRN
ADR	Reverse	1/00	42967
ADR	Reflector	47/00	42966

Fitting Instructions

Can also be used as a replacement lamp for the J2/J3 series lamps
Please refer to ADR 13/00 for mounting instructions.

Accessories

J3B3B - Triple black bracket

Technical Drawings

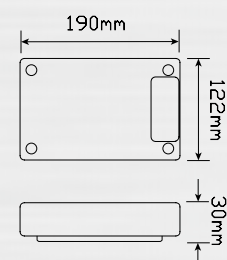

Chrome Surround Coloured Lens Single Function Lamps

- Original design
- Shock, dust & water proof
- 5 Year warranty



Part Number

- 80RMB** - Multivolt 12-24V, Bulk boxed
- 80C1B** - Single chrome bracket

Function	Stop/Tail	
Size	100mm x 100mm x 28mm	
Voltage	Multivolt 12-24V	
LED Qty	36	
Cable	40cm cable	

Draw	Stop	Tail
@13.8V	0.33A	0.06A
@28V	0.25A	0.04A

Approvals	Function	Category	CRN
ADR	Stop	49/00	33059
ADR	Tail	49/00	33059



Part Number

- 80AMB** - Multivolt 12-24V, Bulk boxed
- 80C1B** - Single chrome bracket

Function	Rear Indicator	
Size	100mm x 100mm x 28mm	
Voltage	Multivolt 12-24V	
LED Qty	36	
Cable	40cm cable	

Draw	Indicator
@13.8V	0.31A
@28V	0.22A

Approvals	Function	Category	CRN
ADR	Indicator	6/00/2A	33098



Part Number

- 80WMB** - Multivolt 12-24V, Bulk boxed
- 80C1B** - Single chrome bracket

Function	Reverse	
Size	100mm x 100mm x 28mm	
Voltage	Multivolt 12-24V	
LED Qty	36	
Cable	40cm cable	

Draw	Reverse
@13.8V	0.31A
@28V	0.22A

Approvals	Function	Category	CRN
ADR	Reverse	1/00	35797

Fitting Instructions

Surface mount bracket, run wires through back and clip lens into place. Please refer to ADR 13/00 for mounting instructions.

Technical Drawings

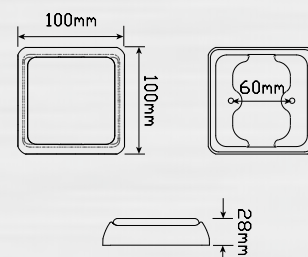

Chrome Surround Coloured Lens Single Function Lamps

- Original design
- Shock, dust & water proof
- 5 Year warranty



Part Number

- 100RMB** - Multivolt 12-24V, Bulk boxed
- 100C1B** - Single chrome bracket

Function Stop/Tail
Size 122mm x 122mm x 31mm
Voltage Multivolt 12-24V
LED Qty 49
Cable 40cm cable

Draw **Stop** **Tail**
@13.8V 0.38A 0.04A
@28V 0.24A 0.04A

Approvals	Function	Category	CRN
ADR	Stop	49/00	33402
ADR	Tail	49/00	33402



Part Number

- 100AMB** - Multivolt 12-24V, Bulk boxed
- 100C1B** - Single chrome bracket

Function Rear Indicator
Size 122mm x 122mm x 31mm
Voltage Multivolt 12-24V
LED Qty 49
Cable 40cm cable

Draw **Indicator**
@13.8V 0.38A
@28V 0.23A

Approvals	Function	Category	CRN
ADR	Indicator	6/00/2A	33156



Part Number

- 100WMB** - Multivolt 12-24V, Bulk boxed
- 100C1B** - Single chrome bracket

Function Reverse
Size 122mm x 122mm x 31mm
Voltage Multivolt 12-24V
LED Qty 25
Cable 40cm cable

Draw **Reverse**
@13.8V 0.31A
@28V 0.17A

Approvals	Function	Category	CRN
ADR	Reverse	1/00	35793

Fitting Instructions

Surface mount bracket, run wires through back and clip lens into place. Please refer to ADR 13/00 for mounting instructions.

Technical Drawings

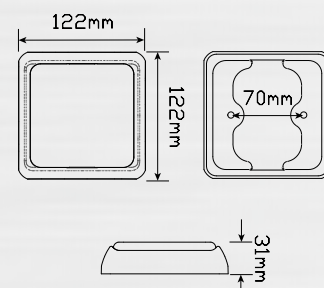

Chrome Surround Coloured Lens Single Function Lamps

- Original design
- Shock, dust & water proof
- 5 Year warranty



Part Number
200CRM - Multivolt 12-24V, Blister single

Function	Stop/Tail		
Size	200mm x 50mm x 28mm		
Voltage	Multivolt 12-24V		
LED Qty	36		
Cable	40cm cable		
Draw	Stop	Tail	
@13.8V	0.32A	0.04A	
@28V	0.18A	0.04A	
Approvals	Function	Category	CRN
ADR	Stop	49/00	35941
ADR	Tail	49/00	35941



Part Number
200CAM - Multivolt 12-24V, Blister single

Function	Rear Indicator		
Size	200mm x 50mm x 28mm		
Voltage	Multivolt 12-24V		
LED Qty	36		
Cable	40cm cable		
Draw	Indicator		
@13.8V	0.39A		
@28V	0.19A		
Approvals	Function	Category	CRN
ADR	Indicator	6/00/2A	35795



Part Number
200CWM - Multivolt 12-24V, Blister single

Function	Reverse		
Size	200mm x 50mm x 28mm		
Voltage	Multivolt 12-24V		
LED Qty	25		
Cable	40cm cable		
Draw	Reverse		
@13.8V	0.34A		
@28V	0.18A		
Approvals	Function	Category	CRN
ADR	Reverse	1/00	35796

Fitting Instructions

Surface mount bracket horizontally, run wires through back and clip lens into place. Please refer to ADR 13/00 for mounting instructions.

Technical Drawings

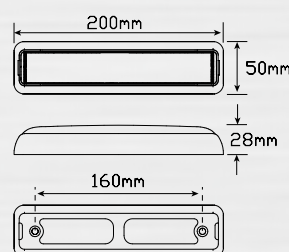

Blister Packaging



Chrome Surround Coloured Lens Single Function Lamps

- American style design
- Shock, dust & water proof
- 5 Year warranty



Function	Stop/Tail		
Size	144mm round x 22mm		
Voltage	Multivolt 12-24V		
LED Qty	10		
Cable	20cm cable		
Draw @13.8V	Stop	Tail	
	0.27A	0.07A	
Approvals ADR	Function	Category	CRN
	Stop/Tail	49/00	45130

Part Number
5543RM - Multivolt 12-24V, Blister single



Function	Rear Indicator		
Size	144mm round x 22mm		
Voltage	Multivolt 12-24V		
LED Qty	10		
Cable	20cm cable		
Draw @13.8V	Indicator		
	0.26A		
Approvals ADR	Function	Category	CRN
	Indicator	6/00CAT2A	45129

Part Number
5543AM - Multivolt 12-24V, Blister single



Function	Reverse		
Size	144mm round x 22mm		
Voltage	12 Volt		
LED Qty	10		
Cable	20cm cable		
Draw @13.8V	Reverse		
	0.15A		
Approvals Nil	Function	Category	CRN
	Reverse	N/A	N/A

Part Number
5543W - 12 Volt, Bulk poly bag

Fitting Instructions

Remove bezel and surface mount to flat surface with screws, clip bezel into place. Please refer to ADR 13/00 for mounting instructions.

Technical Drawings

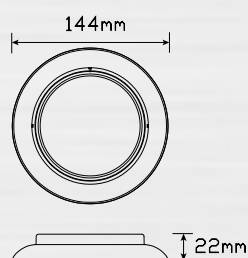

Blister Packaging



Chrome Surround Coloured Lens Single Function Lamps

- American style design
- Shock, dust & water proof
- 5 Year warranty



Part Number
5563R - 12 Volt, Bulk poly bag

Function	Stop/Tail		
Size	191mm x 84mm x 22mm		
Voltage	12 Volt		
LED Qty	10		
Cable	15cm cable		
Draw	Stop	Tail	
@13.8V	0.27A	0.07A	
Approvals	Function	Category	CRN
DOT/SAE	Stop/tail	N/A	N/A



Part Number
5563A - 12 Volt, Bulk poly bag

Function	Rear Indicator		
Size	191mm x 84mm x 22mm		
Voltage	12 Volt		
LED Qty	10		
Cable	15cm cable		
Draw	Indicator		
@13.8V	0.13A		
Approvals	Function	Category	CRN
DOT/SAE	Indicator	N/A	N/A



Part Number
5563W - 12 Volt, Bulk poly bag

Function	Reverse		
Size	191mm x 84mm x 22mm		
Voltage	12 Volt		
LED Qty	10		
Cable	15cm cable		
Draw	Reverse		
@13.8V	0.15A		
Approvals	Function	Category	CRN
DOT/SAE	Reverse	N/A	N/A

Fitting Instructions

Remove chrome bezel and fix to mounting surface using 4 mounting holes in lamp, run wires through back and then fit chrome bezel back onto lamp

Technical Drawings

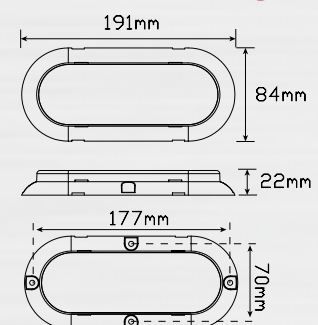

Chrome Surround Coloured Lens Single Function Lamps

- Surface mount
- Shock, dust & water proof
- 5 Year warranty

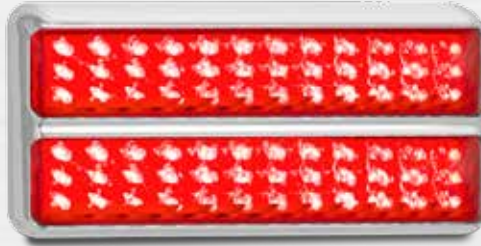

Part Number

- 200RMB** - Multivolt 12-24V, Bulk boxed
200B2C - Bracket, Bulk boxed

Function	Stop/Tail	
Size	200mm x 92mm x 28mm	
Voltage	Multivolt 12-24V	
LED Qty	72	
Cable	40cm cable	
Draw	Stop	Tail
@13.8V	0.64A	0.04A
@28V	0.36A	0.08A

Approvals	Function	Category	CRN
ADR	Stop	49/00	35941
ADR	Tail	49/00	35941

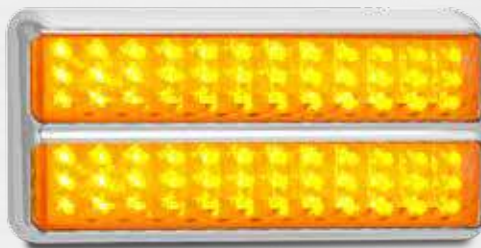

Part Number

- 200AMB** - Multivolt 12-24V, Bulk boxed
200B2C - Bracket, Bulk boxed

Function	Rear Indicator	
Size	200mm x 92mm x 28mm	
Voltage	Multivolt 12-24V	
LED Qty	72	
Cable	40cm cable	
Draw	Indicator	
@13.8V	0.68A	
@28V	0.38A	

Approvals	Function	Category	CRN
ADR	Indicator	6/00/2A	35795

Fitting Instructions

Surface mount bracket onto flat surface horizontally with bolts provided, run wires through back and clip lens into place. Please refer to ADR 13/00 for mounting instructions

Technical Drawings

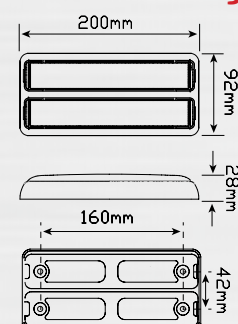

Chrome Surround Coloured Lens Single Function Lamps

- Classic American style
- Shock, dust & water proof
- 5 Year warranty



Part Number
5437R - 12 Volt, Bulk poly bag

Function	Stop/Tail		
Size	200mm x 94mm x 28mm		
Voltage	12 Volt		
LED Qty	24		
Cable	20cm cable		
Draw @13.8V	Stop	Tail	
	0.30A	0.02A	
Approvals ADR	Function	Category	CRN
	Stop/Tail	49/00	37675

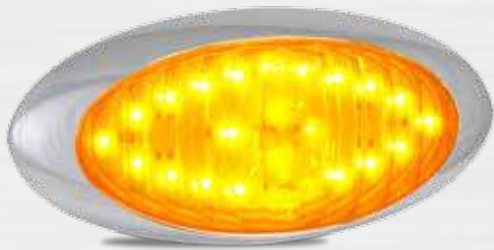

Part Number
5437A - 12 Volt, Bulk poly bag

Function	Rear Indicator		
Size	200mm x 94mm x 28mm		
Voltage	12 Volt		
LED Qty	24		
Cable	20cm cable		
Draw @13.8V	Indicator		
	0.43A		
Approvals ADR	Function	Category	CRN
	Indicator	6/00/2A	37674



Part Number
5437W - 12 Volt, Bulk poly bag

Function	Reverse		
Size	200mm x 94mm x 28mm		
Voltage	12 Volt		
LED Qty	27		
Cable	20cm cable		
Draw @13.8V	Reverse		
	0.14A		
Approvals Nil	Function	Category	CRN
	Reverse	N/A	N/A

Fitting Instructions

Remove chrome bezel and fix lamp onto flat surface horizontally through two screw holes, run wires from back of lamp, click bezel back into place. Please refer to ADR 13/00 for mounting instructions.

Technical Drawings

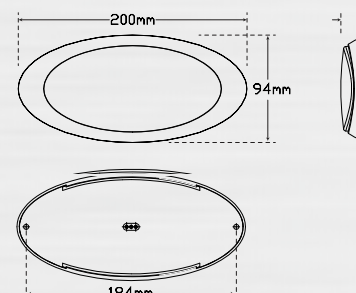

Chrome Surround Coloured Lens Single Function Lamps

- Original design
- Shock, dust & water proof
- 5 Year warranty



Part Number

125RMB - Multivolt 12-24V, Bulk poly bag
125B1C - Single chrome bracket

Function Stop/Tail
Size 147mm x 147mm x 31mm
Voltage Multivolt 12-24V
LED Qty 64
Cable 40cm cable

Draw **Stop** **Tail**
@13.8V 0.42A 0.04A
@28V 0.26A 0.06A

Approvals	Function	Category	CRN
ADR	Stop	49/00	33403
ADR	Tail	49/00	33403



Part Number

125AMB - Multivolt 12-24V, Bulk poly bag
125B1C - Single chrome bracket

Function Rear Indicator
Size 147mm x 147mm x 31mm
Voltage Multivolt 12-24V
LED Qty 64
Cable 40cm cable

Draw **Indicator**
@13.8V 0.43A
@28V 0.25A

Approvals	Function	Category	CRN
ADR	Indicator	6/00/2A	33165



Part Number

125WMB - Multivolt 12-24V, Bulk poly bag
125B1C - Single chrome bracket

Function Reverse
Size 147mm x 147mm x 31mm
Voltage Multivolt 12-24V
LED Qty 25
Cable 40cm cable

Draw **Reverse**
@13.8V 0.36A
@28V 0.18A

Approvals	Function	Category	CRN
ADR	Reverse	1/00	35794

Fitting Instructions

Surface mount bracket, run wires through back and clip lens into place. Please refer to ADR 13/00 for mounting instructions.

Technical Drawings

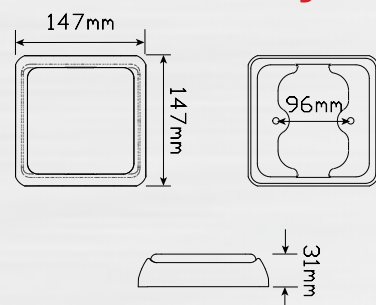

Chrome Surround Coloured Lens Single Function Lamps

- Surface mount
- Shock, dust & water proof
- 5 Year warranty

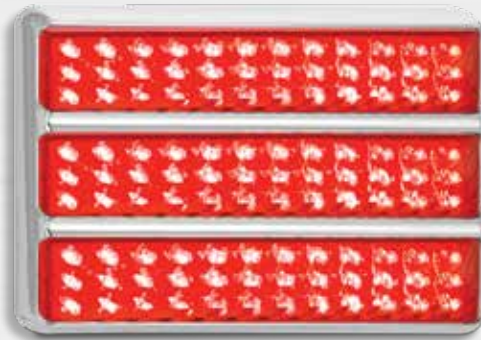

Part Number
200CRRRM - Multivolt 12-24V, Blister single

Function	Stop/Tail		
Size	200mm x 134mm x 28mm		
Voltage	Multivolt 12-24V		
LED Qty	108		
Cable	40cm cable		
Draw	Stop	Tail	
@13.8V	0.96A	0.12A	
@28V	0.54A	0.12A	
Approvals	Function	Category	CRN
ADR	Stop	49/00	35941
ADR	Tail	49/00	35941



Part Number
200CAAAM - Multivolt 12-24V, Blister single

Function	Rear Indicator		
Size	200mm x 134mm x 28mm		
Voltage	Multivolt 12-24V		
LED Qty	108		
Cable	40cm cable		
Draw	Indicator		
@13.8V	1.02A		
@28V	0.57A		
Approvals	Function	Category	CRN
ADR	Indicator	6/00/2A	35795

Fitting Instructions

Surface mount bracket onto flat surface horizontally with bolts provided, run wires through back and clip lens into place. Please refer to ADR 13/00 for mounting instructions.

Technical Drawings

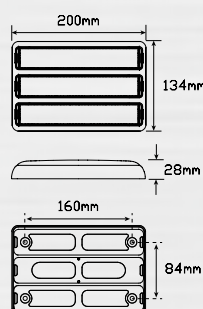

Blister Packaging



Chrome Surround Coloured Lens Single Function Lamps

- Slimline, low profile
- Shock, dust & water proof
- 5 Year warranty



Part Number
380CR12 - 12 Volt, Blister single

Function	Stop/Tail		
Size	404mm x 46mm x 17mm		
Voltage	12 Volt		
LED Qty	18		
Cable	40cm cable		
Draw @13.8V	Stop	Tail	
	0.16A	0.04A	
Approvals	Function	Category	CRN
ADR	Stop	49/00	39473
ADR	Tail	49/00	39473



Part Number
380CA12 - 12 Volt, Blister single

Function	Rear Indicator		
Size	404mm x 46mm x 17mm		
Voltage	12 Volt		
LED Qty	18		
Cable	40cm cable		
Draw @13.8V	Indicator		
	0.18A		
Approvals	Function	Category	CRN
ADR	Indicator	6/00/2A	39470



Part Number
380CW12 - 12 Volt, Blister single

Function	Supplementary reverse		
Size	404mm x 46mm x 17mm		
Voltage	12 Volt		
LED Qty	18		
Cable	40cm cable		
Draw @13.8V	Reverse		
	0.14A		
Approvals	Function	Category	CRN
Nil	Reverse	N/A	N/A

Fitting Instructions

Surface mount onto flat surface horizontally to the ground, run wires through back and fix with screws supplied at both ends. Please refer to ADR13/00 for mounting instructions.

Technical Drawings



Blister Packaging



Clear Lens Single Function Lamps

- Recessed lamp low profile
- Shock, dust & water proof
- 5 Year warranty



Part Number
235CR12 - 12 Volt, Blister single

Function	Stop/Tail		
Size	237mm x 25mm x 3mm		
Voltage	12 Volt		
LED Qty	10		
Cable	40cm Cable		
Draw @13.8V	Stop	Tail	
	0.14A	0.04A	
Approvals ADR	Function	Category	CRN
	Stop/Tail	49/00	43991



Part Number
235CA12 - 12 Volt, Blister single

Function	Rear Indicator		
Size	237mm x 25mm x 3mm		
Voltage	12 Volt		
LED Qty	10		
Cable	40cm Cable		
Draw @13.8V	Indicator		
	0.19A		
Approvals ADR	Function	Category	CRN
	Indicator	6/00/2A	43989



Part Number
235CW12 - 12 Volt, Blister single

Function	Supplementary reverse		
Size	237mm x 25mm x 3mm		
Voltage	12 Volt		
LED Qty	10		
Cable	40cm Cable		
Draw @13.8V	Reverse		
	0.19A		
Approvals Nil	Function	Category	CRN
	Reverse	N/A	N/A

Fitting Instructions

Mount onto flat surface horizontally. Push lamp and grommet into cutout (cut out 203mm x 19mm) in mounting surface, run wires through back and fix with screws supplied at both ends. Please refer to ADR13/00 for mounting instructions.

Technical Drawings

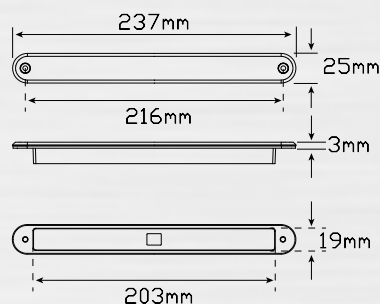

Blister Packaging



Clear Lens Coloured LEDs

- Recessed mount
- Shock, dust & water proof
- 5 Year warranty



Part Number
131CRM - Multivolt 12-24V, Blister single

Function Stop/Tail
Size 134mm x 87mm x 25mm
Voltage Multivolt 12-24V
LED Qty 16
Cable 40cm Spade terminals

Draw **Stop** **Tail**
@13.8V 0.22A 0.03A
@28V 0.12A 0.03A

Approvals **Function** **Category** **CRN**
ADR Stop/Tail 49/00 TBA



Part Number
131CAM - Multivolt 12-24V, Blister single

Function Rear Indicator
Size 134mm x 87mm x 25mm
Voltage Multivolt 12-24V
LED Qty 16
Cable 40cm Spade terminals

Draw **Indicator**
@13.8V 0.19A
@28V 0.11A

Approvals **Function** **Category** **CRN**
ADR Indicator 6/00CAT2A TBA



Part Number
131WM - Multivolt 12-24V, Blister single

Function Reverse
Size 134mm x 87mm x 25mm
Voltage Multivolt 12-24V
LED Qty 16
Cable 40cm Spade terminals

Draw **Reverse**
@13.8V 0.17A
@28V 0.10A

Approvals **Function** **Category** **CRN**
ADR Reverse 1/00 TBA

Fitting Instructions

Retro fit to existing rectangle lamps. If new installation, fit grommet or flange into cutout (cut out 139mm x 91mm), run wires through back then push into grommet/flange. Please refer to ADR 13/00 for mounting instructions.

Accessories



Technical Drawings

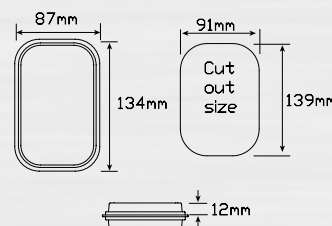

Blister Pack



**Clear Lens
Coloured LEDs**

- Recessed mount
- Shock, dust & water proof
- 5 Year warranty



Part Number
102RC - 12 Volt, Bulk poly bag

Function	Stop/Tail		
Size	130mm round x 12mm		
Voltage	12 Volt		
LED Qty	20		
Cable	36cm Spade terminals		
Draw @13.8V	Stop	Tail	
	0.34A	0.04A	
Approvals ADR	Function	Category	CRN
	Stop/Tail	49/00	42963



Part Number
102AC - 12 Volt, Bulk poly bag

Function	Rear Indicator		
Size	130mm round x 12mm		
Voltage	12 Volt		
LED Qty	20		
Cable	36cm Spade terminals		
Draw @13.8V	Indicator		
	0.61A		
Approvals ADR	Function	Category	CRN
	Indicator	6/00/2A	42832



Part Number
102W - 12 Volt, Bulk poly bag

Function	Reverse		
Size	130mm round x 12mm		
Voltage	12 Volt		
LED Qty	20		
Cable	36cm Spade terminals		
Draw @13.8V	Reverse		
	0.27A		
Approvals ADR	Function	Category	CRN
	Reverse	1/00	42826

Fitting Instructions

Fit into cutout (cutout 104mm round) using stick on gasket between lamp and fitting surface, run wires at back. Please refer to ADR 13/00 for mounting instructions.

Technical Drawings

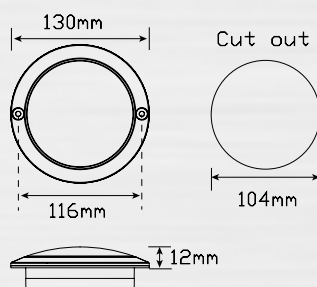

**Clear Lens
Coloured LEDs**

- Original design
- Shock, dust & water proof
- 5 Year warranty



Part Number
200CCRM - Multivolt 12-24V, Blister single

Function	Stop/Tail	
Size	200mm x 50mm x 28mm	
Voltage	Multivolt 12-24V	
LED Qty	12	
Cable	40cm cable	
Draw	Stop	Tail
@13.8V	0.18A	0.02A
@28V	0.12A	0.04A
Approvals	Function	Category CRN
ADR	Stop/Tail	49/00 35941



Part Number
200CCAM - Multivolt 12-24V, Blister single

Function	Rear Indicator	
Size	200mm x 50mm x 28mm	
Voltage	Multivolt 12-24V	
LED Qty	12	
Cable	40cm cable	
Draw	Indicator	
@13.8V	0.20A	
@28V	0.12A	
Approvals	Function	Category CRN
ADR	Indicator	6/00/2A 35795



Part Number
200CCWM - Multivolt 12-24V, Blister single

Function	Reverse	
Size	200mm x 50mm x 28mm	
Voltage	Multivolt 12-24V	
LED Qty	12	
Cable	40cm cable	
Draw	Reverse	
@13.8V	0.21A	
@28V	0.12A	
Approvals	Function	Category CRN
ADR	Reverse	1/00 35796

Fitting Instructions

Surface mount bracket horizontally, run wires through back and clip lens into place. Please refer to ADR 13/00 for mounting instructions.

Technical Drawings

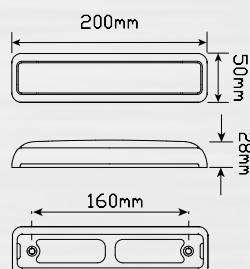

Blister Packaging



**Clear Lens
Coloured LEDs
Chrome Surround**

- Surface mount slimline design
- Shock, dust & water proof
- 5 Year warranty

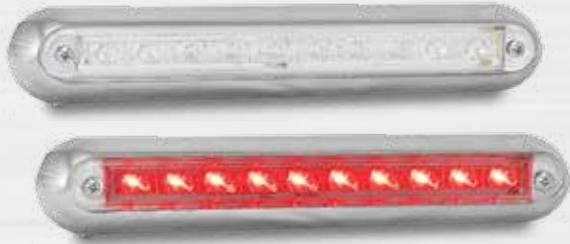

Part Number
235CCR12 - 12 Volt, Blister single

Function	Stop/Tail		
Size	237mm x 46mm x 17mm		
Voltage	12 Volt		
LED Qty	10		
Cable	40cm cable		
Draw @13.8V	Stop	Tail	
	0.14A	0.04A	
Approvals ADR	Function	Category	CRN
	Stop/Tail	49/00	43991



Part Number
235CCA12 - 12 Volt, Blister single

Function	Rear Indicator		
Size	237mm x 46mm x 17mm		
Voltage	12 Volt		
LED Qty	10		
Cable	40cm cable		
Draw @13.8V	Indicator		
	0.19A		
Approvals ADR	Function	Category	CRN
	Indicator	6/00/2A	43989



Part Number
235CCW12 - 12 Volt, Blister single

Function	Supplementary reverse		
Size	237mm x 46mm x 17mm		
Voltage	12 Volt		
LED Qty	10		
Cable	40cm cable		
Draw @13.8V	Reverse		
	0.19A		
Approvals Nil	Function	Category	CRN
	Reverse	N/A	N/A

Fitting Instructions

Surface mount onto flat surface horizontally, run wires through back and fix with screws supplied at both ends. Please refer to ADR13/00 for mounting instructions.

Technical Drawings

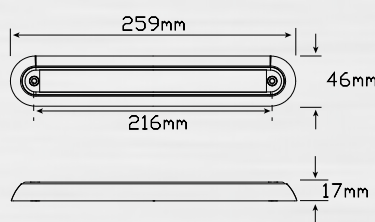

Blister Packaging



**Clear Lens
Coloured LEDs
Chrome Surround**

- Recessed mount
- Shock, dust & water proof
- 5 Year warranty



Function	Stop/Tail		
Size	122mm x 167mm x 11mm		
Voltage	Multivolt 12-24V		
LED Qty	12		
Plug	use plug 53102		
Draw	Stop	Tail	
@13.8V	0.23A	0.03A	
@28V	0.12A	0.04A	
Approvals	Function	Category	CRN
ADR	Stop/tail	49/00	40655

Part Number
130CCRM - Multivolt 12-24V, Blister single



Function	Rear Indicator		
Size	122mm x 167mm x 11mm		
Voltage	Multivolt 12-24V		
LED Qty	12		
Plug	use plug 53102		
Draw	Indicator		
@13.8V	0.20A		
@28V	0.14A		
Approvals	Function	Category	CRN
ADR	Indicator	6/00/2A	36845

Part Number
130CCAM - Multivolt 12-24V, Blister single

Fitting Instructions

Retro fit to existing rectangle lamps. If new installation, fit grommet or flange into cutout (cut out 139mm x 91mm), run wires through back then push into grommet/flange. Please refer to ADR 13/00 for mounting instructions.

Accessories
53102 - Plug



Technical Drawings

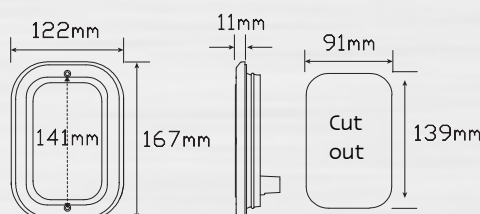

Blister Packaging



**Clear Lens
Coloured LEDs
Chrome Surround**

- Recessed mount
- Shock, dust & water proof
- 5 Year warranty



Function	Stop/Tail		
Size	148mm round x 30mm		
Voltage	Multivolt 12-24V		
LED Qty	12		
Plug	use part 53102		
Draw	Stop	Tail	
@13.8V	0.23A	0.8A	
@28V	0.14A	0.02A	
Approvals	Function	Category	CRN
ADR	Stop/Tail	49/00	35299

Part Number

110CCRM - Multivolt 12-24V, Blister single



Function	Rear Indicator		
Size	148mm round x 30mm		
Voltage	Multivolt 12-24V		
LED Qty	12		
Cable	use part 53102		
Draw	Indicator		
@13.8V	0.16A		
@28V	0.13A		
Approvals	Function	Category	CRN
ADR	Indicator	6/00/2A	35298

Part Number

110CCAM - Multivolt 12-24V, Blister single

Fitting Instructions

Retro fit to existing 4 inch lamps. If new installation fit grommet or flange into cutout (Cut out 115mm round) plug wire into lamp and run through back then push into grommet/flange. Screw chrome housing with screws supplied. Please refer to ADR 13/00 for mounting instructions.

Accessories

53102 - Plug



Technical Drawings

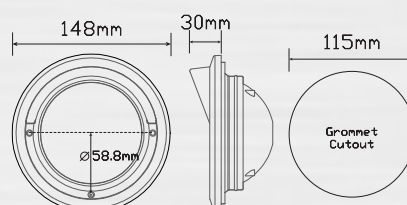

Blister Packaging



**Clear Lens
Coloured LEDs
Chrome Surround**

- Surface mount slimline design
- Shock, dust & water proof
- 5 Year warranty



Function	Stop/Tail		
Size	404mm x 46mm x 17mm		
Voltage	12 Volt		
LED Qty	18		
Cable	40cm cable		
Draw @13.8V	Stop	Tail	
	0.22A	0.03A	
Approvals ADR	Function	Category	CRN
	Stop/Tail	49/00	43990

Part Number
380CCR12 - 12 Volt, Blister single



Function	Rear Indicator		
Size	404mm x 46mm x 17mm		
Voltage	12 Volt		
LED Qty	18		
Cable	40cm cable		
Draw @13.8V	Indicator		
	0.18A		
Approvals ADR	Function	Category	CRN
	Indicator	6/00/2A	35796

Part Number
380CCA12 - 12 Volt, Blister single



Function	Reverse		
Size	404mm x 46mm x 17mm		
Voltage	12 Volt		
LED Qty	18		
Cable	40cm cable		
Draw @13.8V	Reverse		
	0.14A		
Approvals ADR	Function	Category	CRN
	Reverse	1/00	TBA

Part Number
380CCW12 - 12 Volt, Blister single

Fitting Instructions

Surface mount bracket and lights horizontally to ground with screws provided, please refer to ADR 13/00 for mounting instructions

Technical Drawings



Blister Packaging



Combination Lamps Small Vehicle/Trailer

- Premium trailer lamps
- Shock, dust & water proof
- 5 Year warranty



• Smallest LED combination lamp



Inactive

Active

Part Number

81STI - 12 Volt, Blister single

81STIM - Multivolt 12-24V, Blister single

Function	Stop/Tail/Indicator		
Size	81mm x 81mm x 24mm		
Voltage	12 Volt or Multivolt 12-24V		
LED Qty	12		
Cable	30cm cable		
Draw	Stop	Tail	Indicator
@13.8V	0.12A	0.11A	0.02A
@28V	0.07A	0.07A	0.03A
Approvals	Function	Category	CRN
ECE	Stop/Tail	01 2a	11054
ECE	Indicator	02 R1-S1	11054

Part Number - Twin Pack

81STI2 - 12 Volt, Blister twin pack

80STIM2 - Multivolt 12-24V, Blister twin pack



Part Number

80BSTIM - Multivolt 12-24V, Blister single

80BSTIMB - Multivolt 12-24V, Bulk boxed

80BSTIM6 - Multivolt 12-24V, 6m cable, Bulk poly bag

Function	Stop/Tail/Indicator		
Size	100mm x 100mm x 28mm		
Voltage	Multivolt 12-24V		
LED Qty	24		
Cable	40cm cable or 6 meter cable		
Draw	Stop	Tail	Indicator
@13.8V	0.33A	0.06A	0.31A
@28V	0.25A	0.04A	0.22A
Approvals	Function	Category	CRN
ADR	Stop	49/00	35788
ADR	Tail	49/00	35789
ADR	Indicator	6/00/2A	35787

Fitting Instructions

Surface mount onto flat surface with Indicator at top using screws supplied, run wire through 10mm hole in fixing surface. Please refer to ADR 13/00 for mounting instructions.

Technical Drawings

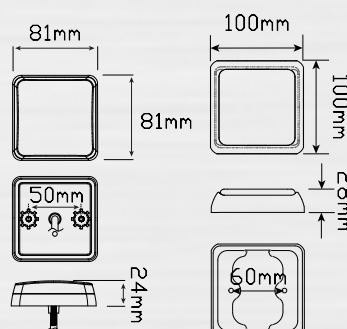

Blister Packaging



Combination Lamps Small Vehicle/Trailer

- Budget trailer lamp
- Shock, dust & water proof
- 5 Year warranty



Part Number

- 99AR** - 12 Volt, Bulk boxed
- 99ARM** - Multivolt 12-24V, Bulk boxed
- 99ARM10** - Multivolt 12-24V, 10m cable, Bulk poly bag

Function	Stop/Tail/Indicator/Reflector		
Size	107mm x 107mm x 23mm		
Voltage	12 Volt and Multivolt 12-24V		
LED Qty	8		
Cable	40cm cable or 10 meter cable		

Draw	Stop	Tail	Indicator
@13.8V	0.07A	0.05A	0.08A
@28V	0.07A	0.06A	0.06A

Approvals	Function	Category	CRN
ECE	Stop/Tail	02R-1S1	6877
ECE	Indicator	E9 01 2a	6877
ECE	Reflector	02 1A	6877

Part Number - Twin Pack

- 99ARL2** - 12 Volt, Blister twin pack
- 99ARLM2** - Multivolt 12-24V, Blister twin pack



Part Number

- 99ARL** - 12 Volt, with licence lamp, Bulk boxed
- 99ARLM** - Multivolt 12-24V, with licence lamp. Bulk boxed
- 99ARLM10** - Multivolt 12-24V, with licence lamp, 10m cable, Bulk poly bag

Function	Stop/Tail/Indicator/Reflector with Inbuilt Licence Lamp		
Size	107mm x 107mm x 23mm		
Voltage	12 Volt and Multivolt 12-24V		
LED Qty	8		
Cable	40cm cable or 10 meter cable		

Draw	Stop	Tail	Indicator
@13.8V	0.07A	0.05A	0.08A
@28V	0.07A	0.06A	0.06A

Approvals	Function	Category	CRN
ECE	Stop/Tail	02R-1S1	6877
ECE	Indicator	E9 01 2a	6877
ECE	Reflector	02 1A	6877
ECE	Licence	E9 00 L	6877

Fitting Instructions

Surface mount onto flat surface with Indicator at top using screws supplied, run wire through 10mm hole in fixing surface. Please refer to ADR 13/00 for mounting instructions.

Technical Drawings

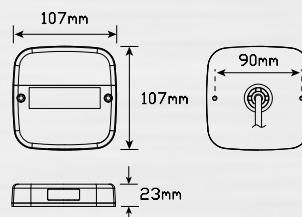

Blister Packaging



Combination Lamps Small Vehicle/Trailer

- Budget trailer lamp
- Shock, dust & water proof
- 5 Year warranty



Part Number
101BAR - 12 Volt, Bulk boxed

Function Stop/Tail/Indicator/Reflector
Size 100mm x 100mm x 22mm
Voltage 12 Volt
LED Qty 8
Cable 40cm cable

Draw @13.8V	Stop	Tail	Indicator
	0.13A	0.04A	0.12A

Approvals	Function	Category	CRN
ECE	Stop/Tail	02R-1S1	6444
ECE	Indicator	01 2a	6444
ECE	Reflector	02 1A	6444

Part Number - Twin Pack

101BAR2 - 12 Volt, Blister twin pack
101BARLP2 - 12 Volt, Blister twin pack with licence plate lamp



Part Number
101BAR10 - 12 Volt, 10m cable, Bulk poly bag

Function Stop/Tail/Indicator/Reflector with Licence Lamp
Size 100mm x 100mm x 22mm
Voltage 12 Volt
LED Qty 8
Cable 40cm cable or 10 meter cable

Draw @13.8V	Stop	Tail	Ind	Lic
	0.13A	0.04A	0.12A	0.03A

Approvals	Function	Category	CRN
ECE	Stop/Tail	02R-1S1	6444
ECE	Indicator	01 2a	6444
ECE	Reflector	02 1A	6444
ECE	Licence	L00	6110

Fitting Instructions

Surface mount onto flat surface vertically with Indicator at top using bolts in back of lamp, run wire through 10mm hole in fixing surface. Please refer to ADR 13/00 for mounting instructions.

Accessories

LP101 - Licence lamp frame

Technical Drawings

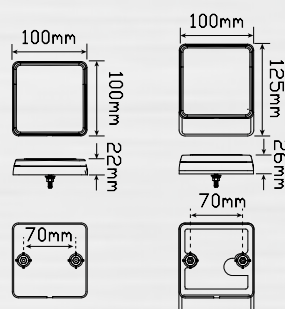

Blister Packaging



Combination Lamps Small Vehicle/Trailer

- Diamond pattern lens
- Premium trailer lamps
- Shock, dust & water proof
- Lifetime warranty



Part Number

- 100BAR** - 12 Volt, White PCB, Bulk boxed
- 100BARB** - 12 Volt, Black PCB, Bulk boxed
- 100ARM** - White PCB, Multivolt 12-24V, Blister single

Function	Stop/Tail/Indicator/Reflector		
Size	100mm x 100mm x 22mm		
Voltage	12 Volt and Multivolt 12-24V		
LED Qty	14		
Cable	40cm with plug		

Draw	Stop	Tail	Indicator
@13.8V	0.13A	0.04A	0.12A
@28V	0.12A	0.06A	0.07A

Approvals	Function	Category	CRN
ADR	Stop/Tail	49/00	37986
ADR	Indicator	6/00/2A	37985
ADR	Reflector	47/00	38102

Part Number - Twin Pack

- 100BAR2** - 12 Volt, Blister twin pack
- 100BARLP2** - 12 Volt, Blister twin pack with licence lamp



Part Number

- 100BAR10** - 12 Volt, 10m cable, Bulk poly bag
- 100ARM10** - Multivolt 12-24V, 10m cable, Bulk poly bag

Function	Stop/tail/Indicator/Reflector with licence lamp			
Size	100mm x 100mm x 22mm			
Voltage	12 Volt and Multivolt 12-24V			
LED Qty	14			
Cable	40cm with plug or 10 meter cable			

Draw	Stop	Tail	Ind	Lic
@13.8V	0.13A	0.04A	0.12A	0.03A
@28V	0.12A	0.06A	0.07A	0.03A

Approvals	Function	Category	CRN
ADR	Stop/Tail	49/00	37986
ADR	Indicator	6/00/2A	37985
ADR	Reflector	47/00	38102
ADR	Licence	L00	6134

Fitting Instructions

Surface mount onto flat surface vertically with Indicator at top using bolts in back of lamp, run wire and plug through 10mm hole in fixing surface. Please refer to ADR 13/00 for mounting instructions.

Accessories

LP100 - Licence lamp frame

Technical Drawings

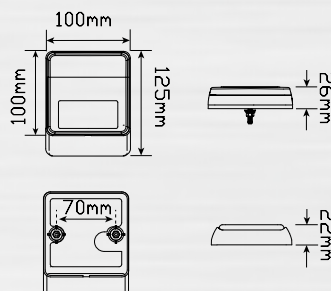

Blister Packaging



Combination Lamps Small Vehicle/Trailer

- Diamond pattern lens
- Premium trailer lamps
- Shock, dust & water proof
- Lifetime warranty



Part Number

- 150BAR** - 12 Volt, White PCB, Bulk boxed
- 150ARM** - Multivolt 12-24V, Blister single
- 150BAR10** - 12 Volt, 10m cable, Bulk poly bag
- 150ARM10** - Multivolt 12-24V, 10m cable, Bulk poly bag

Part Number - Twin Pack

- 150BAR2** - 12 Volt, Blister twin pack
- 150BARLP2** - 12 Volt, Licence lamp frame, Blister twin pack
- 150BARB2** - 12 Volt, Black PCB, Blister twin pack

Function	Stop/Tail/Indicator/Reflector		
Size	150mm x 80mm x 24mm		
Voltage	12 Volt and Multivolt 12-24V		
LED Qty	14		
Cable	40cm with plug or 10 metre cable		
Draw	Stop	Tail	Indicator
@13.8V	0.13A	0.04A	0.12A
@28V	0.12A	0.06A	0.07A
Approvals	Function	Category	CRN
ADR	Stop/Tail	49/00	37381
ADR	Indicator	6/00/2A	37380
ADR	Reflector	47/00	38102

**This is arguably the best
product LED Autolamps
has ever produced,
Please go to
Page 226 for the full story**



Part Number

- 150BARB** - 12 Volt, Black PCB, Bulk boxed

Function	Stop/tail/Indicator/Reflector with Licence Lamp			
Size	150mm x 80mm x 24mm			
Voltage	12 Volt and Multivolt 12-24V			
LED Qty	14			
Cable	40cm cable with plug			
Draw	Stop	Tail	Ind	Lic
@13.8V	0.13A	0.04A	0.12A	0.03A
@28V	0.12A	0.06A	0.07A	0.03A
Approvals	Function	Category	CRN	
ADR	Stop/Tail	49/00	37381	
ADR	Indicator	6/00/2A	37380	
ADR	Reflector	47/00	38102	
ECE	Licence	L00	6110	

Fitting Instructions

Surface mount onto flat surface vertically with Indicator at top using bolts in back of lamp, run wire and plug through 10mm hole in fixing surface. Please refer to ADR 13/00 for mounting instructions.

Accessories

LP151 - Licence lamp frame

Technical Drawings

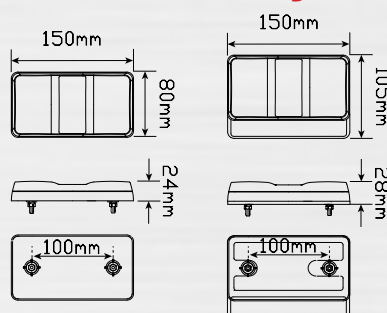

Blister Packaging



Combination Lamps Small Vehicle/Trailer

- Budget trailer lamp
- Shock, dust & water proof
- 5 Year warranty



Function	Stop/Tail/Indicator/Reflector
Size	150mm x 80mm x 22mm
Voltage	12 Volt
LED Qty	8
Cable	40cm cable 10 metre cable

Draw @13.8V	Stop	Tail	Indicator
	0.13A	0.04A	0.12A

Approvals	Function	Category	CRN
ECE	Stop/Tail	02R-1S1	6362
ECE	Indicator	E9 01 2a	6362
ECE	Reflector	02 1A	6362

Part Number

- 151BAR1** - 12 Volt, Blister single pack
- 151BAR** - 12 Volt, Bulk boxed
- 151BAR10** - 12 Volt, 10m cable, Bulk poly bag

Part Number - Twin Pack

- 151BAR2** - 12 Volt, Blister twin pack
- 151BARLP2** - 12 Volt, Blister twin pack with licence lamp



Function	Stop/Tail/Indicator/Reflector with licence lamp
Size	150mm x 80mm x 22mm
Voltage	12 Volt
LED Qty	8
Cable	40cm cable

Draw @13.8V	Stop	Tail	Ind	Lic
	0.13A	0.04A	0.12A	0.03A

Approvals	Function	Category	CRN
ECE	Stop/Tail	02R-1S1	6362
ECE	Indicator	E9 01 2a	6362
ECE	Reflector	02 1A	6362
ECE	Licence	L00	6110

Part Number

- 151BAR** - 12 Volt, Bulk boxed

Fitting Instructions

Surface mount onto flat surface vertically with Indicator at top using bolts in back of lamp, run wire through 10mm hole in fixing surface. Please refer to ADR 13/00 for mounting instructions.

Accessories

LP151 - Licence lamp frame

Technical Drawings

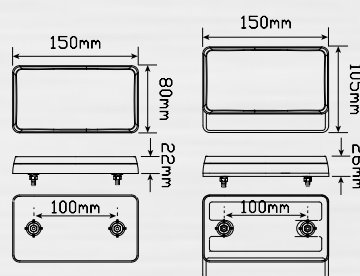

Blister Packaging



Combination Lamps Small Vehicle/Trailer

- Budget trailer lamp
- Shock, dust & water proof
- 5 Year warranty



Part Number

153BAR - 12 Volt, Bulk boxed

153BAR2 - 12 Volt, Blister twin pack

Function	Stop/Tail/Indicator/Reflector		
Size	150mm x 80mm x 22mm		
Voltage	12 Volt		
LED Qty	8		
Cable	40cm cable		
Draw @13.8V	Stop	Tail	Indicator
	0.07A	0.01A	0.06A
Approvals	Function	Category	CRN
ADR	Stop/Tail	49/00	TBA
ADR	Indicator	6/00/2A	TBA
ADR	Reflector	47/00	38102



Part Number

155BAR - 12 Volt, Bulk boxed

155BAR2 - 12 Volt, Blister twin pack

Function	Stop/Tail/Indicator/Reflector		
Size	150mm x 80mm x 22mm		
Voltage	12 Volt		
LED Qty	8		
Cable	40cm cable		
Draw @13.8V	Stop	Tail	Indicator
	0.07A	0.01A	0.06A
Approvals	Function	Category	CRN
ADR	Stop/Tail	49/00	44016
ADR	Indicator	6/00/2A	44015
ADR	Reflector	47/00	38102

Fitting Instructions

Surface mount onto flat surface vertically with Indicator at top using bolts in back of lamp, run wire through 10mm hole in fixing surface. Please refer to ADR 13/00 for mounting instructions.

Technical Drawings

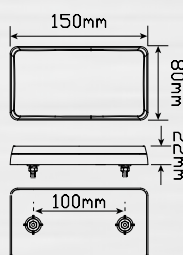

Blister Packaging



Combination Lamps Small Vehicle/Trailer

- High brightness LEDs
- Shock, dust & water proof
- 5 Year warranty

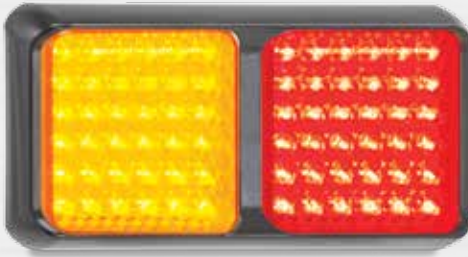

Part Number

- 80BAR** - 12 Volt, Blister single
- 80BARM** - Multivolt 12-24V, Blister single

Function	Stop/Tail/Indicator		
Size	188mm x 100mm x 28mm		
Voltage	12 Volt or Multivolt 12-24V		
LED Qty	72		
Cable	40cm cable		

Draw	Stop	Tail	Indicator
@13.8V	0.33A	0.06A	0.31A
@28V	0.25A	0.04A	0.22A

Approvals	Function	Category	CRN
ADR	Stop/Tail	49/00	33059
ADR	Indicator	6/00/2A	33098



Part Number

- 275GARM** - Multivolt 12-24V, Blister single
- 275GARMB** - Multivolt 12-24V, Bulk boxed



Function	Stop/Tail/Indicator/Reflector		
Size	176mm x 100mm x 33mm		
Voltage	Multivolt 12-24V		
LED Qty	48		
Cable	20cm cable		

Draw	Stop	Tail	Indicator
@13.8V	0.23A	0.04A	0.22A
@28V	0.12A	0.04A	0.12A

Approvals	Function	Category	CRN
ADR	Stop/Tail	49/00	43223
ADR	Indicator	6/00/2A	43221
ADR	Reflector	02 1A	1472



Part Number

- 275RARM** - Multivolt 12-24V, Blister single
- 275RARMB** - Multivolt 12-24V, Bulk boxed



Function	Stop/Tail/Indicator/Reflector		
Size	176mm x 100mm x 33mm		
Voltage	Multivolt 12-24V		
LED Qty	48		
Cable	20cm cable		

Draw	Stop	Tail	Indicator
@13.8V	0.23A	0.04A	0.22A
@28V	0.12A	0.04A	0.12A

Approvals	Function	Category	CRN
ADR	Stop/Tail	49/00	43223
ADR	Indicator	6/00/2A	43221
ADR	Reflector	02 1A	1472

Fitting Instructions

Surface mount onto flat surface horizontally using bolts in back of lamp, run wire and plug through 10mm hole in fixing surface. Please refer to ADR 13/00 for mounting instructions.

Technical Drawings

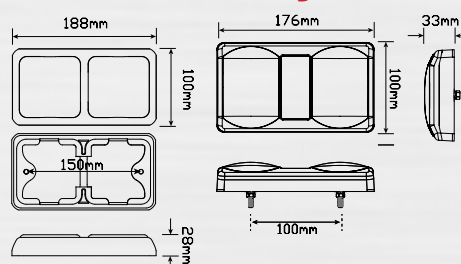

Blister Packaging



Combination Lamps Small Vehicle/Trailer

- Surface or recessed mount
- Shock, dust & water proof
- 5 Year warranty



Part Number
135ARM - Multivolt 12-24V, Surface mounted, Blister single



Part Number
135ARMG - Multivolt 12-24V, Recess mounted, Blister single

Function	Stop/Tail/Indicator		
Size	135mm x 38mm x 24mm 145mm x 48mm x 10mm		
Voltage	Multivolt 12-24V		
LED Qty	18		
Cable	40cm cable		
Draw	Stop	Tail	Indicator
@13.8V	0.12A	0.01A	0.21A
@28V	0.08A	0.02A	0.11A
Approvals	Function	Category	CRN
ADR	Stop/Tail	49/00	39847
ADR	Indicator	6/00/2A	39846



Part Number
200BSTIM - Multivolt 12-24V, Blister single
200BSTIMB - Multivolt 12-24V, Bulk boxed

Function	Stop/Tail/Indicator		
Size	200mm x 50mm x 28mm		
Voltage	Multivolt 12-24V		
LED Qty	24		
Cable	40cm cable		
Draw	Stop	Tail	Indicator
@13.8V	0.29A	0.09A	0.19A
@28V	0.16A	0.07A	0.07A
Approvals	Function	Category	CRN
ADR	Stop	49/00	35785
ADR	Tail	49/00	35786
ADR	Indicator	6/00/2A	35784



Part Number
200BSTIRMB - Multivolt 12-24V, Bulk boxed
200BSTIR48 - 48 Volt, Bulk boxed

Function	Stop/Tail/Indicator/Reverse			
Size	200mm x 50mm x 28mm			
Voltage	Multivolt 12-24V or 48V			
LED Qty	24			
Cable	40cm cable			
Draw	Stop	Tail	Ind	Rev
@28V	0.08A	0.04A	0.08A	0.08A
@48V	0.41A	0.11A	0.40A	0.28A
Approvals	Function	Category	CRN	
N/A	Stop	49/00	N/A	
N/A	Tail	49/00	N/A	
N/A	Indicator	6/00/2A	N/A	

Fitting Instructions

Horizontally surface mount with screws or plugs provided, run wires through back & clip lens into place.

135ARMG - Recess mount horizontally with grommet provided, run wires through back & push lens into place, (cut out for grommet 133mm x 36mm) Refer to ADR 13/00 for mounting instructions.

Technical Drawings

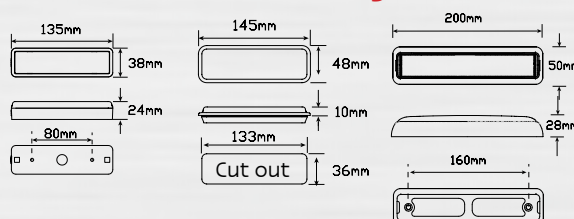

Blister Packaging



Combination Lamps Small Vehicle/Trailer

- High brightness slimline design
- Shock, dust & water proof
- 5 Year warranty



Inactive



Active

Part Number

- 200BIRSTME2** - Multivolt 12-24V, Black PCB, Blister twin
200BIRSTMEB - Multivolt 12-24V, Bulk boxed

Function	Stop/Tail/Indicator/Reverse			
Size	200mm x 50mm x 28mm			
Voltage	Multivolt 12-24V			
LED Qty	36			
Cable	40cm cable			

Draw	Stop	Tail	Ind	Rev
@13.8V	0.20A	0.02A	0.20A	0.23A
@28V	0.11A	0.02A	0.11A	0.14A

Approvals	Function	Category	CRN
ECE	Stop/Tail	49/00	TBA
ECE	Indicator	45/01	TBA
ECE	Reverse	1/00	TBA

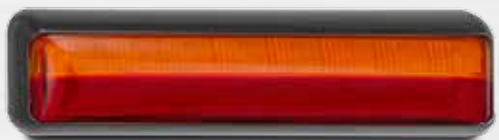

Inactive



Active

Part Number

- 201BSTIM** - Multivolt 12-24V, Blister single
201BSTIMB - Multivolt 12-24V, Bulk boxed

Function	Stop/Tail/Indicator			
Size	200mm x 50mm x 28mm			
Voltage	Multivolt 12-24V			
LED Qty	16			
Cable	40cm cable			

Draw	Stop	Tail	Ind
@13.8V	0.13A	0.02A	0.13A
@28V	0.40A	0.03A	0.40A

Approvals	Function	Category	CRN
ADR	Stop	49/00	TBA
ADR	Tail	49/00	TBA
ADR	Indicator	6/00/2A	TBA

Fitting Instructions

Horizontally mount bracket onto flat surface with screws provided, run wires through back and clip lens into place. Please refer to ADR 13/00.

Technical Drawings

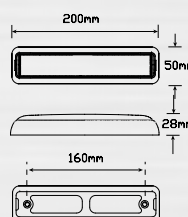

Blister Packaging



Combination Lamps Small Vehicle/Trailer

- Slimline design
- Shock, dust & water proof
- 5 Year warranty



Part Number

- 235BBSTI12** - 12 Volt, Black PCB, Blister single
235WWSTI12 - 12 Volt, White PCB, White bracket, Bulk boxed

Function	Stop/Tail/Indicator		
Size	259mm x 46mm x 17mm		
Voltage	12 Volt		
LED Qty	12		
Cable	40cm cable		
Draw @13.8V	Stop	Tail	Indicator
	0.17A	0.02A	0.17A
Approvals	Function	Category	CRN
ECE	Stop/Tail	2a E9 01	11436
ECE	Indicator	R1 Si E9	11436



Part Number

- 380BBSTI12** - 12 Volt, Black PCB, Blister single
380WWSTI12 - 12 Volt, White PCB, White bracket, Bulk boxed

Function	Stop/Tail/Indicator		
Size	404mm x 46mm x 17mm		
Voltage	12 Volt		
LED Qty	18		
Cable	40cm cable		
Draw @13.8V	Stop	Tail	Indicator
	TBA	TBA	TBA
Approvals	Function	Category	CRN
ECE	Stop/Tail	2a E9 01	11821
ECE	Indicator	R1 S1 02	11821

Fitting Instructions

Surface mount bracket onto flat surface horizontally, run wires through back and fix with screws supplied at both ends. Please refer to ADR 13/00.

Technical Drawings

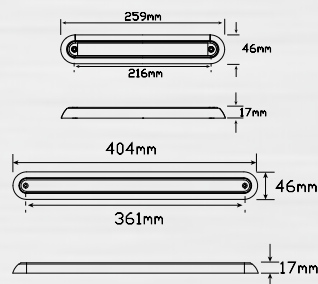

Blister Packaging



Combination Lamps Small Vehicle/Trailer

- Boat trailer lamp design
- Shock, dust & water proof
- 5 Year warranty

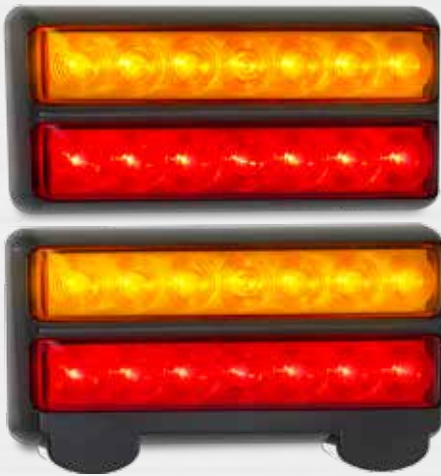

Part Number

- 207BARLP2** - 12 Volt, LHS/RHS Blister twin pack
- 207BARP** - 12 Volt, Bulk poly bag
- 207BARL** - 12 Volt, licence lamp, Bulk poly bag

Function	Stop/Tail/Indicator and Stop/Tail/Indicator/Licence			
Size	200mm x 92mm x 28mm			
Voltage	12 Volt			
LED Qty	14, 4 (Licence)			
Cable	40cm cable with plug			
Draw	Stop	Tail	Ind	Lic
@13.8V	0.18A	0.07A	0.17A	0.02A
@28V	0.32A	0.04A	0.39A	0.02A
Approvals	Function	Category	CRN	
ADR	Stop/Tail	49/00	37371	
ADR	Indicator	6/00/2A	37350	
ADR	Licence	47/00	37845	

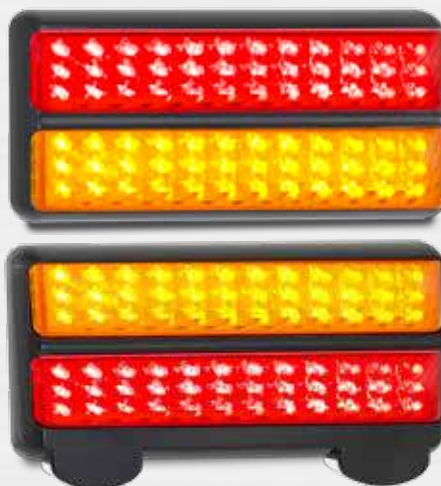

Part Number

- 200BARLPM2** - Multivolt 12-24V, Blister twin pack
- 200BARM** - Multivolt 12-24V, Bulk poly bag
- 200BARLPM** - Multivolt 12-24V, licence lamp, Bulk poly bag

Function	Stop/Tail/Indicator and Stop/Tail/Indicator/Licence			
Size	200mm x 92mm x 28mm			
Voltage	Multivolt 12-24V			
LED Qty	72, 4 (Licence)			
Cable	40cm cable with plug			
Draw	Stop	Tail	Ind	Lic
@13.8V	0.18A	0.07A	0.17A	0.02A
@28V	0.32A	0.04A	0.39A	0.02A
Approvals	Function	Category	CRN	
ADR	Stop/Tail	49/00	35941	
ADR	Indicator	6/00/2A	35795	
ADR	Licence	47/00	37844	

Fitting Instructions

Surface mount onto flat surface horizontally with stainless steel bolts provided in assembly and run cable through 12mm hole. Please refer to ADR 13/00.

Accessories

- 7030-1 - Reflector
- 200AMB - Indicator
- 200RMB - Stop/tail

Technical Drawings

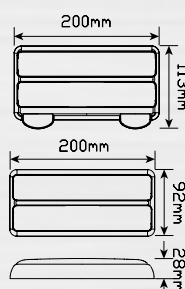

Blister Packaging



Combination Lamps Small Vehicle/Trailer

- High brightness LEDs
- Shock, dust & water proof
- 7 Year warranty



Part Number
MaXilampC1XRE - Multivolt 12-24V, Blister single

Function	Stop/Tail/Indicator/Reflector		
Size	125mm round x 40mm		
Voltage	Multivolt 12-24V		
LED Qty	30		
Cable	40cm cable		
Draw	Stop	Tail	Ind
@13.8V	0.34A	0.07A	0.37A
@28V	0.17A	0.06A	0.16A
Approvals	Function	Category	CRN
ECE	Stop/Tail	02 R1-S1	6064
ECE	Indicator	01 2a	6064
ECE	Reflector	02 1A	1472



Part Number
MaXilamp1XRE - Multivolt 12-24V, Blister single

Function	Stop/Tail/Indicator/Reflector		
Size	125mm round x 40mm		
Voltage	Multivolt 12-24V		
LED Qty	30		
Cable	40cm cable		
Draw	Stop	Tail	Ind
@13.8V	0.34A	0.07A	0.37A
@28V	0.17A	0.06A	0.16A
Approvals	Function	Category	CRN
ECE	Stop/Tail	02 R1-S1	6064
ECE	Indicator	01 2a	6064
ECE	Reflector	02 1A	1472



Part Number
MaXilamp1XRWE - Multivolt 12-24V, Blister single

Function	Reverse/Reflector		
Size	125mm round x 40mm		
Voltage	Multivolt 12-24V		
LED Qty	30		
Cable	40cm cable		
Draw	Reverse		
@13.8V	0.39A		
@28V	0.23A		
Approvals	Function	Category	CRN
ECE	Reverse	AR 00	1150

Fitting Instructions

Surface mount using bolts in back of lamp, run wire through hole in fixing surface. Please refer to ADR 13/00 for mounting instructions.

Technical Drawings

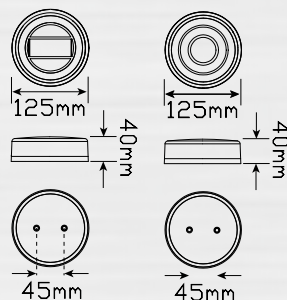

Blister Packaging



Combination Lamps Small Vehicle/Trailer

- High brightness LEDs
- Shock, dust & water proof
- 7 Year warranty



Part Number
MaXilampC1XCE - Multivolt 12-24V, Blister single

Function	Stop/Tail/Indicator/Reflector		
Size	125mm round x 40mm		
Voltage	Multivolt 12-24V		
LED Qty	30		
Cable	40cm cable		
Draw	Stop	Tail	Ind
@13.8V	0.34A	0.07A	0.37A
@28V	0.17A	0.06A	0.16A
Approvals	Function	Category	CRN
ECE	Stop/Tail	02 R1-S1	6445
ECE	Indicator	01 2a	6445
ECE	Reflector	02 1A	6445



Part Number
MaXilamp1XC - Multivolt 12-24V, Blister single

Function	Stop/Tail/Indicator/Reflector		
Size	125mm round x 40mm		
Voltage	Multivolt 12-24V		
LED Qty	30		
Cable	40cm cable		
Draw	Stop	Tail	Ind
@13.8V	0.34A	0.07A	0.37A
@28V	0.17A	0.06A	0.16A
Approvals	Function	Category	CRN
ECE	Stop/Tail	02 R1-S1	6445
ECE	Indicator	01 2a	6445
ECE	Reflector	02 1A	6445



Part Number
MaXilamp1XCWE - Multivolt 12-24V, Blister single

Function	Reverse/Reflector		
Size	125mm round x 40mm		
Voltage	Multivolt 12-24V		
LED Qty	30		
Cable	40cm cable		
Draw	Reverse		
@13.8V	0.39A		
@28V	0.23A		
Approvals	Function	Category	CRN
ECE	Reverse	AR 00	1152

Fitting Instructions

Surface mount using bolts in back of lamp, run wire through hole in fixing surface. Please refer to ADR 13/00 for mounting instructions.

Technical Drawings

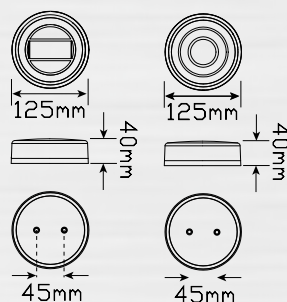

Blister Packaging



Combination Lamps Small Vehicle/Trailer

- Easy fit - No tools required
- Shock, dust & water proof
- 5 Year warranty



Part Number

EU140TFM - Multivolt 12-24V, Blister single

EU140TFMB - Multivolt 12-24V, Bulk poly bag

Function	Fog lamp		
Size	140mm Round x 20mm		
Voltage	Multivolt 12-24V		
LED Qty	24		
Cable	40cm cable		
Draw	Fog		
@13.8V	0.38A		
@28V	0.24A		
Approvals	Function	Category	CRN
ECE	Fog	F1-00	11172

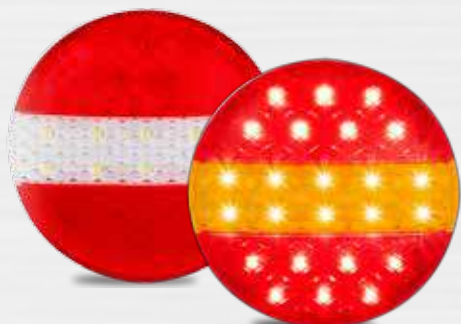

Part Number

EU140STIM - Multivolt 12-24V, Blister single

EU140STIMB - Multivolt 12-24V, Bulk poly bag

Function	Stop/Tail/Indicator		
Size	140mm Round x 20mm		
Voltage	Multivolt 12-24V		
LED Qty	24		
Cable	40cm cable		
Draw	Stop	Tail	Ind
@13.8V	0.54A	0.08A	0.77A
@28V	0.17A	0.06A	0.16A
Approvals	Function	Category	CRN
ECE	Stop/Tail	02 R1-S1	11171
ECE	Indicator	01 2a	11171

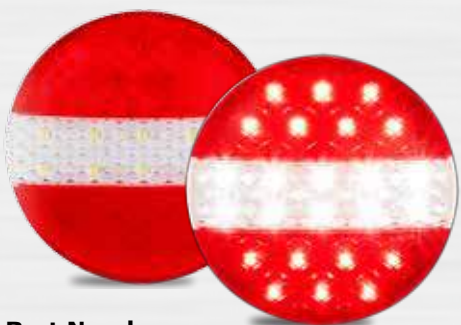

Part Number

EU140TRM - Multivolt 12-24V, Blister single

EU140TRMB - Multivolt 12-24V, Bulk poly bag

Function	Stop/Tail/Reverse		
Size	140mm Round x 20mm		
Voltage	Multivolt 12-24V		
LED Qty	24		
Cable	40cm cable		
Draw	Stop	Tail	Rev
@13.8V	0.54A	0.08A	0.39A
@28V	0.17A	0.06A	0.23A
Approvals	Function	Category	CRN
ECE	Tail	02 R1	11318
ECE	Reverse	AR 00	11318

Fitting Instructions

Drill two 10mm holes for serrated plugs and one 12mm hole or larger for the cable. Remove the protective film from the back and simply push into place



Technical Drawings

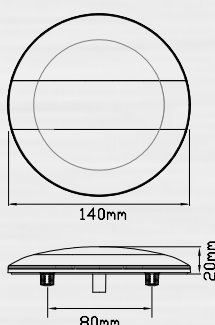

Blister Packaging



Combination Lamps Small Vehicle/Trailer

- Clip in lens with no visible screws
- Shock, dust & water proof
- 5 Year warranty



Part Number
200BARM - Multivolt 12-24V, Blister single

Function	Stop/Tail/Indicator		
Size	200mm x 92mm x 28mm		
Voltage	Multivolt 12-24V		
LED Qty	72		
Cable	40cm cable		
Draw	Stop	Tail	Indicator
@13.8V	0.32A	0.04A	0.34A
@28V	0.18A	0.04A	0.19A
Approvals	Function	Category	CRN
ADR	Stop/Tail	49/00	35941
ADR	Indicator	6/00/2A	35795

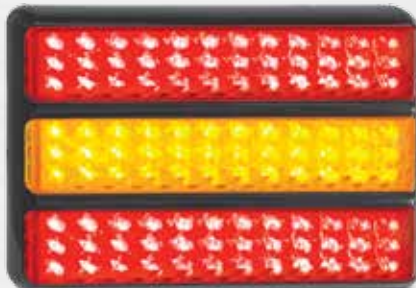

Part Number
200BARRM - Multivolt 12-24V, Blister single

Function	Stop/Tail/Indicator		
Size	200mm x 134mm x 28mm		
Voltage	Multivolt 12-24V		
LED Qty	108		
Cable	40cm cable		
Draw	Stop	Tail	Indicator
@13.8V	0.32A	0.04A	0.34A
@28V	0.18A	0.04A	0.19A
Approvals	Function	Category	CRN
ADR	Stop/Tail	49/00	35941
ADR	Indicator	6/00/2A	35795



Part Number
200BARWM - Multivolt 12-24V, Blister single

Function	Stop/Tail/Indicator/Reverse			
Size	200mm x 134mm x 28mm			
Voltage	Multivolt 12-24V			
LED Qty	97			
Cable	40cm cable			
Draw	Stop	Tail	Ind	Rev
@13.8V	0.32A	0.04A	0.34A	0.17A
@28V	0.18A	0.04A	0.19A	0.18A
Approvals	Function	Category	CRN	
ADR	Stop/Tail	49/00	35941	
ADR	Indicator	6/00/2A	35795	
ADR	Reverse	1/00	35796	

Fitting Instructions

Surface mount bracket onto flat surface horizontally with bolts provided, run wires through back and clip lens into place. Please refer to ADR 13/00.

Accessories

- 200B2B - Twin Bracket
- 200B3B - Triple Bracket
- 200BAMB - Indicator
- 200BRMB - Stop/tail
- 200BWMB - Reverse

Technical Drawings

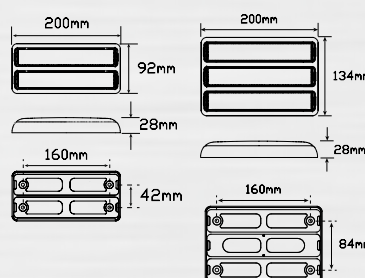

Blister Packaging



Combination Lamps Small Vehicle/Trailer

- Diamond lens pattern
- Shock, dust & water proof
- 5 Year warranty



Part Number

250RARM - Multivolt 12-24V, Blister single

Function	Stop/Tail/Indicator/Reflector		
Size	250mm x 80mm x 24mm		
Voltage	Multivolt 12-24V		
LED Qty	23		
Cable	40cm cable		

Draw	Stop	Tail	Indicator
@13.8V	0.11A	0.02A	0.16A
@28V	0.07A	0.02A	0.09A

Approvals	Function	Category	CRN
ADR	Stop/Tail	49/00	43362
ADR	Indicator	6/00/2A	43361
ADR	Reflector	47/00	38102



Part Number

250ARWM - Multivolt 12-24V, Blister single

Function	Stop/tail/Indicator/Reverse/Reflector			
-----------------	---------------------------------------	--	--	--

Size	250mm x 80mm x 24mm			
Voltage	Multivolt 12-24V			
LED Qty	33			
Cable	40cm cable			

Draw	Stop	Tail	Ind	Rev
@13.8V	0.04A	0.32A	0.32A	0.24A
@28V	0.17A	0.03A	0.17A	0.13A

Approvals	Function	Category	CRN
ECE	Stop/Tail	02R-1S1	6461
ECE	Indicator	01 2a	6461
ECE	Reverse	00 AR	6461
ECE	Reflector	02 1A	6461

Fitting Instructions

Surface mount using bolts in back of lamp, run wire and plug through 10mm hole in fixing surface. Please refer to ADR 13/00 for mounting instructions.

Technical Drawings

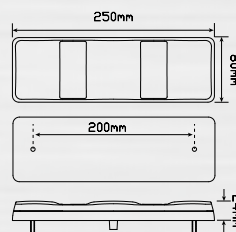

Blister Packaging



Combination Lamps Small Vehicle/Trailer

- Modern design square combination
- Horizontal and vertical mount
- Shock, dust & water proof
- 5 Year warranty



NEW DESIGN SQUARE SERIES LAMP

Function	Stop/Tail/Indicator		
Size	284mm x 100mm x 27mm		
Voltage	Multivolt 12-24V		
LED Qty	48		
Cable	20cm cable		
Draw	Stop	Tail	Indicator
@13.8V			
@28V			
Approvals	Function	Category	CRN

Part Number

282ARRM - Multivolt 12-24V, Blister single

282ARRMB - Multivolt 12-24V, Bulk boxed



NEW DESIGN SQUARE SERIES LAMP

Function	Stop/Tail/Indicator/Reverse			
Size	284mm x 100mm x 37mm			
Voltage	Multivolt 12-24V			
LED Qty	48			
Cable	20cm cable			
Draw	Stop	Tail	Ind	Rev
@13.8V				
@28V				
Approvals	Function	Category	CRN	

Part Number

282ARWM - Multivolt 12-24V, Blister single

282ARWMB - Multivolt 12-24V, Bulk boxed

Fitting Instructions

Horizontally surface mount using bolts in back of lamp, run wire and plug through 10mm hole in fixing surface. Please refer to ADR 13/00 for mounting instructions.

Technical Drawings

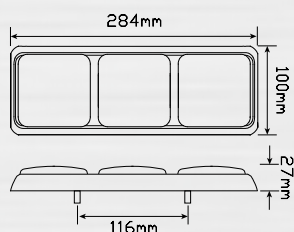

Blister Packaging



Combination Lamps Small Vehicle/Trailer

- New design mini jumbo
- Horizontal and vertical mount
- Shock, dust & water proof
- 5 Year warranty



Part Number
280ARRM - Multivolt 12-24V, Blister single

Function	Stop/Tail/Indicator with reflector included			
Size	282mm x 95mm x 28mm			
Voltage	Multivolt 12-24V			
LED Qty	36			
Cable	40cm cable			
Draw	Stop	Tail	Ind	
@13.8V	0.30A	0.04A	0.14A	
@28V	0.22A	0.06A	0.11A	
Approvals	Function	Category	CRN	
ECE	Stop/Tail	02 R1 S1	11544	
ECE	Indicator	01 2a	11545	



Part Number
280ARWM - Multivolt 12-24V, Blister single

Function	Stop/Tail/Indicator/Reverse with reflector included			
Size	282mm x 95mm x 28mm			
Voltage	Multivolt 12-24V			
LED Qty	36			
Cable	40cm cable			
Draw	Stop	Tail	Ind	Rev
@13.8V	0.15A	0.02A	0.14A	0.17A
@28V	0.11A	0.03A	0.11A	0.13A
Approvals	Function	Category	CRN	
ECE	Stop/Tail	02 R1 S1	11544	
ECE	Indicator	01 2a	11545	
ECE	Reverse	00 AR	1207	

Fitting Instructions

Surface mount onto flat surface horizontally with stainless steel bolts provided in assembly and run cable through 12mm hole. Please refer to ADR 13/00.

Technical Drawings

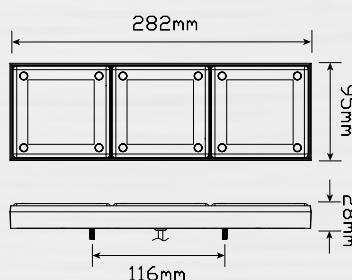

Blister Packaging



Combination Lamps Small Vehicle/Trailer

- Made in Melbourne Australia
- High brightness 72 LEDs
- 5 Year warranty



Part Number
275GARWM - Multivolt 12-24V, Blister single
275GARWMB - Multivolt 12-24V, Bulk boxed



Function	Stop/Tail/Indicator/Reverse with Reflector			
Size	275mm x 100mm x 33mm			
Voltage	Multivolt 12-24V			
LED Qty	72			
Cable	20cm cable			
Draw	Stop	Tail	Ind	Rev
@13.8V	0.23A	0.04A	0.22A	0.16A
@28V	0.12A	0.04A	0.12A	0.09A
Approvals	Function	Category	CRN	
ADR	Stop/Tail	49/00	43223	
ADR	Indicator	6/00/2A	43221	
ADR	Reverse	1/00	43222	
ADR	Reflector	02 1A	1472	



Part Number
275RARWM - Multivolt 12-24V, Blister single
275RARWMB - Multivolt 12-24V, Bulk boxed



Function	Stop/Tail/Indicator/Reverse with Reflector			
Size	275mm x 100mm x 33mm			
Voltage	Multivolt 12-24V			
LED Qty	72			
Cable	20cm cable			
Draw	Stop	Tail	Ind	Rev
@13.8V	0.23A	0.04A	0.22A	0.16A
@28V	0.12A	0.04A	0.12A	0.09A
Approvals	Function	Category	CRN	
ADR	Stop/Tail	49/00	43223	
ADR	Indicator	6/00/2A	43221	
ADR	Reverse	1/00	43222	
ADR	Reflector	02 1A	1472	

Fitting Instructions

Horizontally mount onto flat surface using bolts in back of lamp, run wire and plug through 10mm hole in fixing surface. Please refer to ADR 13/00 for mounting instructions.

Technical Drawings

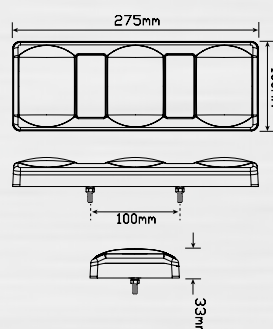

Blister Packaging



Combination Lamps Small Vehicle/Trailer

- Individual lens replacements
- Shock, dust & water proof
- 5 Year warranty



Part Number

80BARR - 12 Volt, Blister single

80BARRM - Multivolt 12-24V, Blister single

Order Separately

80B3BB - Black Bracket, Bulk

80AMB - Indicator, Bulk

80RMB - Stop/tail, Bulk

Function	Stop/Tail/Indicator		
Size	278mm x 100mm x 28mm		
Voltage	12 Volt and Multivolt 12-24V		
LED Qty	108		
Cable	40cm cable		
Draw	Stop	Tail	Indicator
@13.8V	0.33A	0.06A	0.29A
@28V	0.25A	0.04A	0.22A
Approvals	Function	Category	CRN
ADR	Stop/Tail	49/00	33059
ADR	Indicator	6/00/2A	33098



Part Number

80BARW - 12 Volt, Blister single

80BARWM - Multivolt 12-24V, Blister single

Order Separately

80B3BB - Black Bracket, Bulk

80AMB - Indicator, Bulk

80RMB - Stop/tail, Bulk

80WMB - Reverse, Bulk

Function	Stop/Tail/Indicator/Reverse			
Size	278mm x 100mm x 28mm			
Voltage	12 Volt and Multivolt 12-24V			
LED Qty	97			
Cable	40cm cable			
Draw	Stop	Tail	Ind	Rev
@13.8V	0.33A	0.06A	0.29A	0.17A
@28V	0.25A	0.04A	0.22A	0.21A
Approvals	Function	Category	CRN	
ADR	Stop/Tail	49/00	33059	
ADR	Indicator	6/00/2A	33098	
ADR	Reverse	1/00	35797	

Fitting Instructions

Horizontally mount onto flat surface with screws provided, run wires through back and clip lens into place. Please refer to ADR 13/00

Accessories

80B3B - Black Bracket

80AMB - Indicator

80RMB - Stop/tail

80WMB - Reverse

Technical Drawings

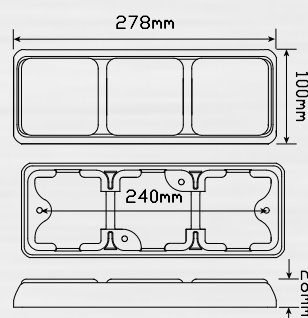

Blister Packaging



Combination Lamps Small Vehicle/Trailer

- Individual lens replacements
- Shock, dust & water proof
- 5 Year warranty



Part Number

80BARRSKT - 12 Volt, Blister twin pack

- 90° Angle bracket design

Function	Stop/Tail/Indicator		
Size	280mm x 110mm x 29mm		
Voltage	12 Volt		
LED Qty	97		
Cable	40cm cable		

Draw	Stop	Tail	Indicator
@13.8V	0.33A	0.06A	0.29A
@28V	0.25A	0.04A	0.22A

Approvals	Function	Category	CRN
ADR	Stop/Tail	49/00	33059
ADR	Indicator	6/00/2A	33098



Part Number

80BARWSKT - 12 Volt, Blister twin pack

- 90° Angle bracket design

Function	Stop/Tail/Indicator/Reverse			
Size	280mm x 110mm x 29mm			
Voltage	12 Volt			
LED Qty	97			
Cable	40cm cable			

Draw	Stop	Tail	Ind	Rev
@13.8V	0.33A	0.06A	0.29A	0.17A
@28V	0.25A	0.04A	0.22A	0.21A

Approvals	Function	Category	CRN
ADR	Stop/Tail	49/00	33059
ADR	Indicator	6/00/2A	33098
ADR	Reverse	1/00	35797

Fitting Instructions

Mount 90° bracket to the underside of vehicle horizontally to the ground with screws provided. Please refer to ADR 13/00 for mounting instructions.

Accessories

- 80B3B - Black Bracket
- 80AMB - Indicator
- 80RMB - Stop/tail
- 80WMB - Reverse

Technical Drawings

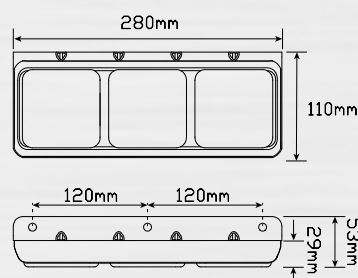

Blister Packaging



Combination Lamps Small Vehicle/Trailer

- Diamond lens pattern
- Shock, dust & water proof
- Lifetime warranty



Part Number

- 275BAR** - 12 Volt, White PCB, Bulk boxed
- 275BAR2** - 12 Volt, Blister twin pack
- 275ARM** - Multivolt 12-24V, Blister single

Function	Stop/Tail/Indicator/Reflector		
Size	275mm x 100mm x 22mm		
Voltage	12 Volt and Multivolt 12-24V		
LED Qty	16		
Cable	30cm cable with plug		
Draw	Stop	Tail	Indicator
@13.8V	0.14A	0.07A	0.10A
@28V	0.11A	0.05A	0.12A
Approvals	Function	Category	CRN
ADR	Stop/Tail	49/00	38658
ADR	Indicator	6/00/2A	38657
ADR	Reflector	47/00	38102



Part Number

- 275BARB** - 12 Volt, Black PCB, Bulk boxed

Function	Stop/Tail/Indicator/Reflector		
Size	275mm x 100mm x 22mm		
Voltage	12 Volt		
LED Qty	16		
Cable	30cm cable with plug		
Draw	Stop	Tail	Indicator
@13.8V	0.14A	0.07A	0.10A
@28V	0.11A	0.05A	0.12A
Approvals	Function	Category	CRN
ADR	Stop/Tail	49/00	38658
ADR	Indicator	6/00/2A	38657
ADR	Reflector	47/00	38102

Fitting Instructions

Horizontally mount onto flat surface with Indicator at top using bolts in back of lamp, run wire and plug through 10mm hole in fixing surface. Please refer to ADR 13/00 for mounting instructions.

Technical Drawings

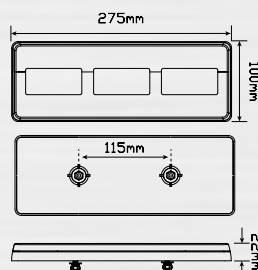

Blister Packaging



Combination Lamps Small Vehicle/Trailer

- Individual lens replacements
- Shock, dust & water proof
- 5 Year warranty



Part Number
80BAARRM - Multivolt 12-24V, Blister single

Function	Stop/Tail/Indicator		
Size	350mm x 105mm x 48mm		
Voltage	Multivolt 12-24V		
LED Qty	144		
Cable	40cm cable		
Draw	Stop	Tail	Indicator
@13.8V	0.38A	0.04A	0.38A
@28V	0.25A	0.04A	0.22A
Approvals	Function	Category	CRN
ADR	Stop/Tail	49/00	33059
ADR	Indicator	6/00/2A	33098



Part Number
80BARRWM - Multivolt 12-24V, Blister single

Function	Stop/Tail/Indicator/Reverse			
Size	350mm x 105mm x 48mm			
Voltage	Multivolt 12-24V			
LED Qty	133			
Cable	40cm cable			
Draw	Stop	Tail	Ind	Rev
@13.8V	0.38A	0.04A	0.38A	0.31A
@28V	0.25A	0.04A	0.22A	0.21A
Approvals	Function	Category	CRN	
ADR	Stop/Tail	49/00	33059	
ADR	Indicator	6/00/2A	33098	
ADR	Reverse	1/00	35797	

Fitting Instructions

Horizontally mount bracket onto flat surface with bolts at back of assembly. Please refer to ADR 13/00 for mounting instructions.

Accessories

- 80AMB - Indicator
- 80RMB - Stop/tail
- 80WMB - Reverse

Technical Drawings

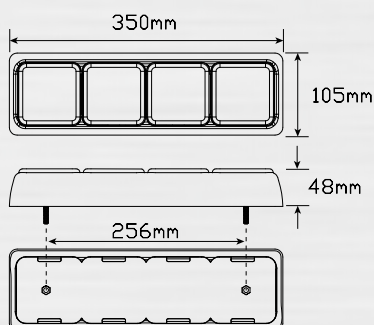

Blister Packaging



Combination Lamps Small Vehicle/Trailer

- European design lamps
- Shock, dust & water proof
- 5 Year warranty



Part Number
EU200LR2 - Multivolt 12-24V, Left/Right side, Blister twin pack

Function	Stop/Tail/Indicator/Reverse/ Fog and Reflector				
Size	200mm x 150mm x 25mm				
Voltage	Multivolt 12-24V				
LED Qty	46				
Cable	40cm cable				
Draw	Stop	Tail	Ind	Rev	Fog
@13.8V	0.31A	0.01A	0.15A	0.27A	0.15A
@28V	0.19A	0.01A	0.09A	0.15A	0.10A
Approvals	Function	Category	CRN		
ECE	Stop/Tail	02R-1S1	11173		
ECE	Indicator	01 2a	11173		
ECE	Reverse	00 AR	11173		
ECE	Fog	01 F1	11173		
ECE	Reflector	02 1A	11173		



Part Number
EU195LR2 - Multivolt 12-24V, Left/Right side, Blister twin pack

Function	Stop/Tail/Indicator/Reverse/ Fog and Reflector				
Size	195mm x 180mm x 22mm				
Voltage	Multivolt 12-24V				
LED Qty	38				
Cable	40cm cable				
Draw	Stop	Tail	Ind	Rev	Fog
@13.8V	0.24A	0.04A	0.17A	0.02A	0.17A
@28V	0.15A	0.03A	0.09A	0.12A	0.09A
Approvals	Function	Category	CRN		
ECE	Stop/Tail	02R-1S1	11057		
ECE	Indicator	01 2a	11057		
ECE	Reverse	00 AR	11057		
ECE	Fog	01 F1	11057		
ECE	Reflector	02 1A	11057		

Fitting Instructions

Horizontally or vertically mount onto flat surface using bolts in back of lamp, run wire and plug through 10mm hole in fixing surface. Please refer to ADR 13/00 for mounting instructions.

Technical Drawings

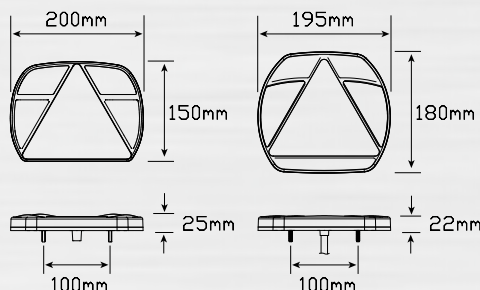

Blister Packaging



Combination Lamps Medium Vehicle/Trailer

- Premium lamps
- Shock, dust & water proof
- 5 Year warranty



Part Number
235BAR12 - 12 Volt, Blister single



Part Number
380BAR12 - 12 Volt, Blister single

Function	235BAR Stop/Tail/Indicator		
Size	258mm x 82mm x 17mm		
Voltage	12 Volt		
LED Qty	20		
Cable	40cm cable		
Draw @13.8V	Stop 0.14A	Tail 0.04A	Indicator 0.16A
Approvals	Function	Category	CRN
ADR	Stop/Tail	49/00	37678
ADR	Indicator	6/00/2A	39092

Function	380BAR Stop/Tail/Indicator		
Size	428mm x 97mm x 22mm		
Voltage	12 Volt		
LED Qty	36		
Cable	40cm Cable		
Draw @13.8V	Stop 0.16A	Tail 0.04A	Indicator 0.18A
Approvals	Function	Category	CRN
ADR	Stop/Tail	49/00	39473
ADR	Indicator	6/00/2A	39470



Part Number
125BARMR - Multivolt 12-24V, RHS Bulk boxed
125BARMML - Multivolt 12-24V, LHS Bulk boxed

Accessories

- 125AMB - Indicator
- 125RMB - Stop/tail

Function	Stop/Tail/Indicator/Reflector		
Size	340mm x 200mm x 60mm		
Voltage	Multivolt 12-24V		
LED Qty	128		
Cable	40cm cable		
Draw @13.8V	Stop 0.42A	Tail 0.04A	Indicator 0.43A
Draw @28V	0.26A	0.06A	0.26A
Approvals	Function	Category	CRN
ADR	Stop/Tail	49/00	33403
ADR	Indicator	6/00/2A	33165
ADR	Reflector	47/00	38102

Fitting Instructions

235/380 - Horizontally mount on to flat surface using screws provided, run wire through hole in fixing surface. Please refer to ADR 13/00 for mounting instructions.

125BAR - Horizontally secure using top or back mounting holes in assemblies and run wires through back.

Technical Drawings

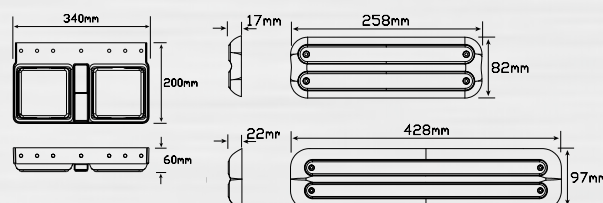

Blister Packaging



Combination Lamps Medium Vehicle/Trailer

- Individual lens replacements
- Shock, dust & water proof
- 5 Year warranty

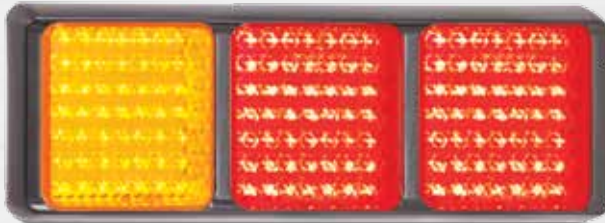

Part Number

100BARRM - Multivolt 12-24V, Blister single

Order Separately

100B3B - Black Bracket, Bulk
100AMB - Indicator, Bulk
100RMB - Stop/tail, Bulk

Function Stop/Tail/Indicator
Size 350mm x 120mm x 31mm
Voltage Multivolt 12-24V
LED Qty 147
Cable 40cm cable

Draw	Stop	Tail	Indicator
@13.8V	0.38A	0.04A	0.38A
@28V	0.24A	0.07A	0.23A

Approvals	Function	Category	CRN
ADR	Stop/Tail	49/0	33402
ADR	Indicator	6/00/2A	33156

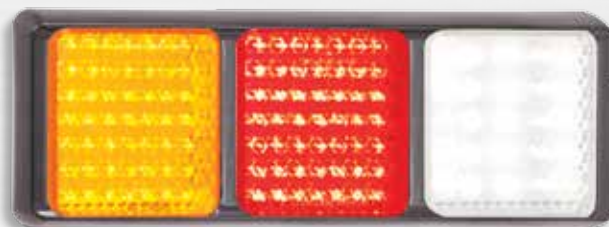

Part Number

100BARWM - Multivolt 12-24V, Blister single

Order Separately

100B3B - Black Bracket, Bulk
100AMB - Indicator, Bulk
100RMB - Stop/tail, Bulk
100WMB - Reverse, Bulk

Function Stop/Tail/Indicator/Reverse
Size 350mm x 120mm x 31mm
Voltage Multivolt 12-24V
LED Qty 123
Cable 40cm cable

Draw	Stop	Tail	Ind	Rev
@13.8V	0.38A	0.04A	0.38A	0.31A
@28V	0.24A	0.07A	0.23A	0.17A

Approvals	Function	Category	CRN
ADR	Stop/Tail	49/00	33402
ADR	Indicator	6/00/2A	33156
ADR	Reverse	1/00	35793

Fitting Instructions

Horizontally mount bracket onto flat surface with screws provided, run wires through back and clip lens into place. Please refer to ADR 13/00 for mounting instructions.

Accessories

100AMB - Indicator
100RMB - Stop/tail
100WMB - Reverse

Technical Drawings

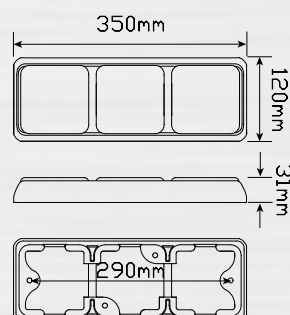

Blister Packaging



Combination Lamps Medium Vehicle/Trailer

- New design mini jumbo
- Horizontal and vertical mount
- Shock, dust & water proof
- 5 Year warranty



Part Number
420AARRM - Multivolt 12-24V, Blister single

Function Stop/Tail/Indicator/Reflector
Size 420mm x 95mm x 28mm
Voltage Multivolt 12-24V
LED Qty 48
Cable 1.2 meter cable

Draw	Stop	Tail	Ind
@13.8V	0.30A	0.04A	0.28A
@28V	0.22A	0.06A	0.22A

Approvals	Function	Category	CRN
ECE	Stop/Tail	02 R1 S1	11544
ECE	Indicator	01 2a	11545



Part Number
420ARRWM - Multivolt 12-24V, Blister single

Function Stop/Tail/Indicator/
Reverse/Reflector
Size 420mm x 95mm x 28mm
Voltage Multivolt 12-24V
LED Qty 48
Cable 1.2 meter cable

Draw	Stop	Tail	Ind	Rev
@13.8V	0.30A	0.04A	0.14A	0.17A
@28V	0.22A	0.06A	0.11A	0.13A

Approvals	Function	Category	CRN
ECE	Stop/Tail	02 R1 S1	11544
ECE	Indicator	02 2a	11545
ECE	Reverse	00 AR	1207

Fitting Instructions

Surface mount onto flat surface horizontally with stainless steel bolts provided in assembly and run cable through 12mm hole. Please refer to ADR 13/00.

Technical Drawings

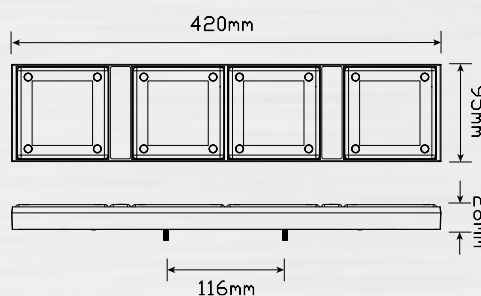

Blister Packaging



Combination Lamps Medium Vehicle/Trailer

- Individual lens replacements
- Easy fit bolt on design
- 5 Year warranty



Part Number
207BAR4 - 12 Volt, Bulk boxed

Function	Stop/Tail/Indicator		
Size	400mm x 92mm x 40mm		
Voltage	12 Volt		
LED Qty	144		
Cable	40cm cable		
Draw	Stop	Tail	Indicator
@13.8V	0.36A	0.14A	0.34A
@28V	0.64A	0.08A	0.78A
Approvals	Function	Category	CRN
ADR	Stop/Tail	49/00	37371
ADR	Indicator	6/00/2A	37350



Part Number
207BARL4 - 12 Volt, Bulk boxed

Function	Stop/Tail/Indicator/Licence			
Size	400mm x 113mm x 40mm			
Voltage	12 Volt			
LED Qty	144			
Cable	40cm cable			
Draw	Stop	Tail	Ind	Lic
@13.8V	0.36A	0.14A	0.34A	0.02A
@28V	0.64A	0.08A	0.78A	0.02A
Approvals	Function	Category	CRN	
ADR	Stop/Tail	49/00	37371	
ADR	Indicator	6/00/2A	37350	
ADR	Licence	47/00	37845	



Part Number
207BAR6 - 12 Volt, Blister single

Function	Stop/Tail/Indicator		
Size	400mm x 135mm x 40mm		
Voltage	12 Volt		
LED Qty	216		
Cable	40cm cable		
Draw	Stop	Tail	Indicator
@13.8V	0.54A	0.21A	0.51A
@28V	0.96A	0.12A	1.17A
Approvals	Function	Category	CRN
ADR	Stop/Tail	49/00	35941
ADR	Indicator	6/00/2A	35795

Fitting Instructions

Horizontally mount onto flat surface with stainless steel bolts provided in assembly and run cable through 12mm hole. Please refer to ADR 13/00.

Accessories

- 207A12 - Indicator
- 207R12 - Stop/tail

Technical Drawings

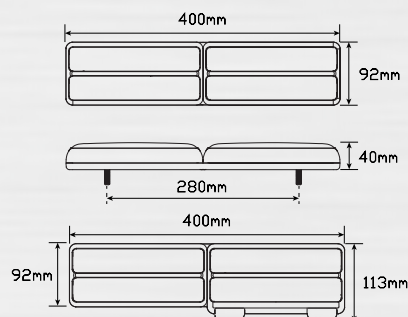

Blister Packaging



Combination Lamps Medium Vehicle/Trailer

- Individual lens replacements
- Easy fit bolt on design
- 5 Year warranty



Part Number
200BARM4 - Multivolt 12-24V, Blister single

Function	Stop/Tail/Indicator		
Size	400mm x 92mm x 40mm		
Voltage	Multivolt 12-24V		
LED Qty	144		
Cable	40cm cable		
Draw	Stop	Tail	Indicator
@13.8V	0.36A	0.14A	0.34A
@28V	0.64A	0.08A	0.78A
Approvals	Function	Category	CRN
ADR	Stop/Tail	49/00	35941
ADR	Indicator	6/00/2A	35795



Part Number
200BARLM4 - Multivolt 12-24V, Blister single

Function	Stop/Tail/Indicator/Licence			
Size	400mm x 113mm x 40mm			
Voltage	Multivolt 12-24V			
LED Qty	144			
Cable	40cm cable			
Draw	Stop	Tail	Ind	Lic
@13.8V	0.36A	0.14A	0.34A	0.02A
@28V	0.64A	0.08A	0.78A	0.02A
Approvals	Function	Category	CRN	
ADR	Stop/Tail	49/00	35941	
ADR	Indicator	6/00/2A	35795	
ADR	Licence	47/00	37844	



Part Number
200BARM6 - Multivolt 12-24V, Bulk boxed

Function	Stop/Tail/Indicator		
Size	400mm x 135mm x 40mm		
Voltage	Multivolt 12-24V		
LED Qty	216		
Cable	40cm cable		
Draw	Stop	Tail	Indicator
@13.8V	0.54A	0.21A	0.51A
@28V	0.96A	0.12A	1.17A
Approvals	Function	Category	CRN
ADR	Stop/Tail	49/00	37371
ADR	Indicator	6/00/2A	37350

Fitting Instructions

Horizontally mount onto flat surface with stainless steel bolts provided in assembly and run cable through 12mm hole. Please refer to ADR 13/00.

Accessories

200AMB - Indicator
200RMB - Stop/tail

Technical Drawings

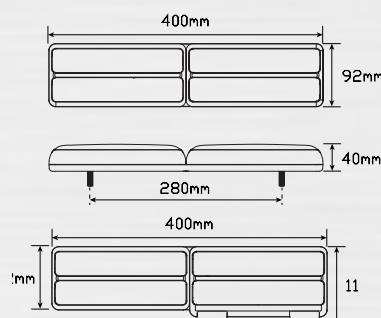

Blister Packaging



Combination Lamps Medium Vehicle/Trailer

- European inspired design
- Shock, dust & water proof
- 5 Year warranty



Part Number

- EU390LB** - Multivolt 12-24V, LHS Bulk boxed
- EU390RB** - Multivolt 12-24V, RHS Bulk boxed
- EU390LR2** - Multivolt 12-24V, LHS/RHS Blister twin pack

Function	Stop/Tail/Indicator/Reverse/ Fog/Reflector				
Size	390mm x 140mm x 20mm				
Voltage	Multivolt 12-24V				
LED Qty	66				
Cable	40cm cable				
Draw	Stop	Tail	Ind	Rev	Fog
@13.8V	0.59A	0.47A	0.55A	0.58A	0.44A
@28V	0.38A	0.25A	0.31A	0.29A	0.29A
Approvals	Function	Category	CRN		
ECE	Stop/Tail	49/00	11295		
ECE	Indicator	6/00/2A	11295		
ECE	Reverse	1/00	11295		
ECE	Reflector	47/00	11295		



Part Number

- LUMILAMPLB** - Multivolt 12-24V, LHS Bulk boxed
- LUMILAMP2** - Multivolt 12-24V, LHS/RHS Blister twin pack
- LUMILAMP2** - Multivolt 12-24V, LHS/RHS Blister twin pack

Function	Stop/Tail/Indicator/Reverse/ Reflector, side marker				
Size	390mm x 150mm x 44mm				
Voltage	Multivolt 12-24V				
LED Qty	88				
Cable	40cm cable				
Draw	Stop	Tail	Ind	Rev	
@13.8V	0.55A	0.51A	0.58A	0.48A	
@28V	0.27A	0.26A	0.27A	0.32A	
Approvals	Function	Category	CRN		
ADR	Stop/Tail	49/00	42101		
ADR	Indicator	6/00/2A	42103		
ADR	Reverse	1/00	41986		
ADR	Reflector	47/00	42102		

Fitting Instructions

Horizontally mount onto flat surface using bolts in back of lamp, run wire through hole in fixing surface.

Please refer to ADR 13/00 for mounting instructions

Technical Drawings

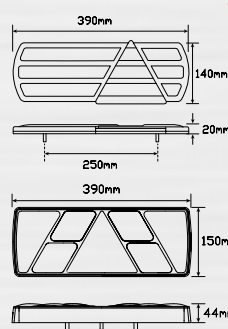

Blister Packaging



Combination Lamps Medium Vehicle/Trailer

- Dual lamp jumbo design
- Shock, dust & water proof
- 5 Year warranty



Part Number
J2BARM - Multivolt 12-24V, Blister single

Function Stop/Tail/Indicator/Reflector
Size 400mm x 130mm x 45mm
Voltage Multivolt 12-24V
LED Qty 48
Cable 1.20 meter cable

Draw	Stop	Tail	Indicator
@13.8V	0.47A	0.04A	0.42A
@28V	0.27A	0.03A	0.28A

Approvals	Function	Category	CRN
ADR	Stop/Tail	49/00	42965
ADR	Indicator	6/00/2A	42964
ADR	Reflector	47/00	42966

- Stainless steel with ultra narrow design and 90° mounting bracket



Part Number
135CARRM - Multivolt 12-24V, Bulk boxed

Function Stop/Tail/Indicator/Reverse
Size 470mm x 70mm x 40mm
Voltage Multivolt 12-24V
LEDs 24
Cable 40cm cable

Draw	Stop	Tail	Ind	Rev
@13.8V	0.11A	0.02A	0.16A	0.23A
@28V	0.08A	0.02A	0.06A	0.19A



Part Number
135CARWML - Multivolt 12-24V, LHS Bulk boxed
135CARWMR - Multivolt 12-24V, RHS Bulk boxed
135CARWM2 - Multivolt 12-24V, LHS/RHS Blister twin pack

Approvals	Function	Category	CRN
ADR	Stop/Tail	49/00	39848
ADR	Indicator	6/00/2A	39845
ADR	Reverse	1/00	39849

Fitting Instructions

Horizontally mount using fixing points. Refer to ADR 13/00 for mounting

Accessories

- 135AMB - Indicator
- 135RMB - Stop/tail
- 135WMB - Reverse
- J3AMB - Indicator
- J3RMB - Stop/tail

Technical Drawings

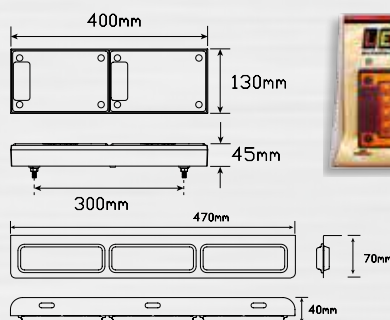

Blister Packaging



Combination Lamps Medium Vehicle/Trailer

- Great looking stop/tail design
- Shock, dust & water proof
- 5 Year warranty



Part Number

- 102BARR** - 12 Volt, Individual lamp and bracket assembly
102BARRM - Multivolt 12-24V, Individual lamp and bracket assembly

Function	Stop/Tail/Indicator		
Size	438mm x 148mm x 45mm		
Voltage	12 volt or Multivolt 12-24V		
LED Qty	63		
Cable	40cm cable		

Draw	Stop	Tail	Ind
@13.8V	0.62A	0.08A	0.29A
@28V	0.57A	0.08A	0.20A

Approvals	Function	Category	CRN
ADR	Stop/Tail	49/00	42963
ADR	Indicator	06/00	42832



Part Number

- 102BARW** - 12 Volt, Individual lamp and bracket assembly
102BARWM - Multivolt 12-24V, Individual lamp and bracket assembly

Function	Stop/Tail/Indicator/Reverse			
Size	438mm x 148mm x 45mm			
Voltage	12 volt or Multivolt 12-24V			
LED Qty	63			
Cable	40cm cable			

Draw	Stop	Tail	Ind	Rev
@13.8V	0.31A	0.04A	0.29A	0.15A
@28V	0.19A	0.04A	0.20A	0.11A

Approvals	Function	Category	CRN
ADR	Stop/Tail	49/00	42963
ADR	Indicator	6/00	42832
ADR	Reverse	1/00	42826

Fitting Instructions

Horizontally mount onto flat surface using Screws in back of lamp, run wire through hole in fixing surface. Please refer to ADR 13/00 for mounting instructions.

Technical Drawings

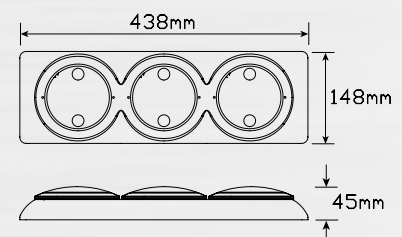

Combination Lamps Medium Vehicle/Trailer

- Ideal for the caravan industry
- Shock, dust & water proof
- 5 Year warranty



Part Number

- 102WARR** - 12 Volt, Individual lamp and bracket assembly
102WARRM - Multivolt 12-24V, Individual lamp and bracket assembly

Function	Stop/Tail/Indicator		
Size	438mm x 148mm x 45mm		
Voltage	12 volt or Multivolt 12-24V		
LED Qty	63		
Cable	40cm cable		

Draw	Stop	Tail	Ind
@13.8V	0.62A	0.08A	0.29A
@28V	0.57A	0.08A	0.20A

Approvals	Function	Category	CRN
ADR	Stop/Tail	49/00	42963
ADR	Indicator	06/00	42832



Part Number

- 102WARW** - 12 Volt, Individual lamp and bracket assembly
102WARWM - Multivolt 12-24V, Individual lamp and bracket assembly

Function	Stop/Tail/Indicator/Reverse			
Size	438mm x 148mm x 45mm			
Voltage	12 volt or Multivolt 12-24V			
LED Qty	63			
Cable	40cm cable			

Draw	Stop	Tail	Ind	Rev
@13.8V	0.31A	0.04A	0.29A	0.15A
@28V	0.19A	0.04A	0.20A	0.11A

Approvals	Function	Category	CRN
ADR	Stop/Tail	49/00	42963
ADR	Indicator	6/00	42832
ADR	Reverse	1/00	42826

Fitting Instructions

Horizontally mount onto flat surface using screws in back of lamp, run wire through hole in fixing surface. Please refer to ADR 13/00 for mounting instructions.

Technical Drawings

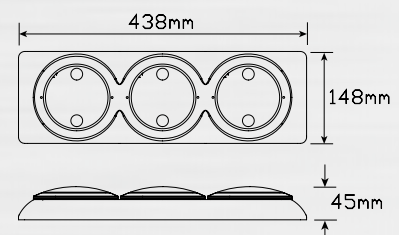

Combination Lamps Large Vehicle/Trailer

- Robust heavy duty design
- Shock, dust & water proof
- 5 Year warranty



Part Number
100BAARRM - Multivolt 12-24V, Blister single

Function	Stop/Tail/Indicator		
Size	430mm x 125mm x 50mm		
Voltage	Multivolt 12-24V		
LED Qty	196		
Cable	40cm cable		
Draw	Stop	Tail	Indicator
@13.8V	0.38A	0.04A	0.38A
@28V	0.24A	0.07A	1.23A
Approvals	Function	Category	CRN
ADR	Stop/Tail	49/00	33402
ADR	Indicator	6/00/2A	33156



Part Number
100BARRWM - Multivolt 12-24V, Blister single

Function	Stop/Tail/Indicator/Reverse			
Size	430mm x 125mm x 50mm			
Voltage	Multivolt 12-24V			
LED Qty	196			
Cable	40cm cable			
Draw	Stop	Tail	Ind	Rev
@13.8V	0.38A	0.04A	0.38A	0.29A
@28V	0.24A	0.07A	1.23A	0.17A
Approvals	Function	Category	CRN	
ADR	Stop/Tail	49/00	33402	
ADR	Indicator	6/00/2A	33156	
ADR	Reverse	1/00	35793	

Fitting Instructions

Horizontally mount onto flat surface with bolts at back of assembly. Please refer to ADR 13/00 for mounting instructions.

Accessories

- 100AMB - Indicator
- 100RMB - Stop/tail
- 100WMB - Reverse

Technical Drawings

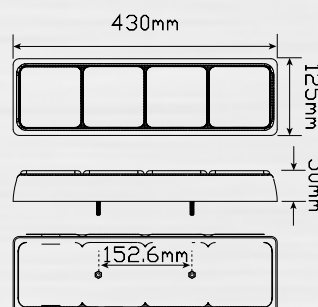

Blister Packaging



Combination Lamps Large Vehicle/Trailer

- Individual lens replacements
- Shock, dust & water proof
- 5 Year warranty



Part Number
125BARRM - Multivolt 12-24V, Blister single
Order Separately
 125B3B - Black Bracket, Bulk
 125AMB - Indicator, Bulk
 125RMB - Stop/tail, Bulk

Function	Stop/Tail/Indicator		
Size	435mm x 146mm x 31mm		
Voltage	Multivolt 12-24V		
LED Qty	192		
Cable	40cm cable		
Draw	Stop	Tail	Indicator
@13.8V	0.42A	0.04A	0.43A
@28V	0.26A	0.06A	0.25A
Approvals	Function	Category	CRN
ADR	Stop/Tail	49/00	33403
ADR	Indicator	6/00/2A	33165

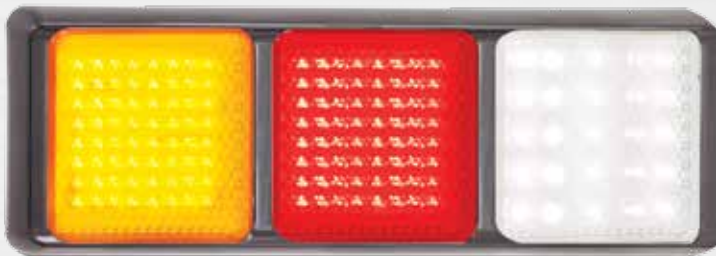

Part Number
125BARWM - Multivolt 12-24V, Blister single
Order Separately
 125B3B - Black Bracket, Bulk
 125AMB - Indicator, Bulk
 125RMB - Stop/tail, Bulk
 125WMB - Reverse, Bulk

Function	Stop/Tail/Indicator/Reverse			
Size	435mm x 146mm x 31mm			
Voltage	Multivolt 12-24V			
LED Qty	153			
Cable	40cm cable			
Draw	Stop	Tail	Ind	Rev
@13.8V	0.42A	0.04A	0.43A	0.36A
@28V	0.26A	0.06A	0.25A	0.18A
Approvals	Function	Category	CRN	
ADR	Stop/Tail	49/00	33403	
ADR	Indicator	6/00/2A	33165	
ADR	Reverse	1/00	35794	

Fitting Instructions

Horizontally mount onto flat surface with screws provided, run wires through back and clip lens into place. Please refer to ADR 13/00 for mounting instructions.

Accessories

- 125AMB - Indicator
- 125RMB - Stop/tail
- 125WMB - Reverse

Technical Drawings

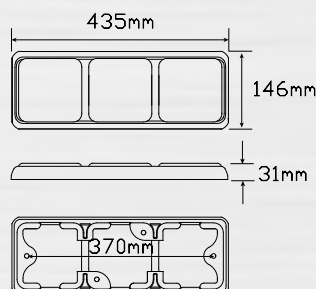

Blister Packaging



Combination Lamps Large Vehicle/Trailer

- New mid sized Jumbo
- Horizontal and vertical mount
- Shock, dust & water proof
- 5 Year warranty



Part Number
460ARRM - Multivolt 12-24V, Blister single
460ARRMB - Multivolt 12-24V, Bulk boxed



Part Number
460ARWM - Multivolt 12-24V, Blister single
460ARWMB - Multivolt 12-24V, Bulk boxed



Part Number
460RRRMB - Multivolt 12-24V, Bulk boxed

Function	Stop/Tail/Indicator/Reverse/Reflector	Approvals	Function	Category	CRN	Draw	Stop	Tail	Ind	Rev
		ECE	Stop/Tail	02 R1-S1	11293	@13.8V	0.30A	0.02A	0.32A	0.19A
Size	460mm x 130mm x 33mm	ECE	Indicator	01 2a	6205	@28V	0.17A	0.04A	0.18A	0.12A
Voltage	Multivolt 12-24V	ECE	Reverse	00 AR	1208					
LED Qty	48	ECE	Reflector	02 1A	1472					
Cable	1.2 meter cable									

Fitting Instructions

Horizontally mount onto flat surface using bolts in back of lamp, run wire through hole in fixing surface. Please refer to ADR 13/00 for mounting instructions.

Accessories

- 460RMB - Stop/tail
- 460AMB - Indicator
- 460WMB - Reverse

Technical Drawings

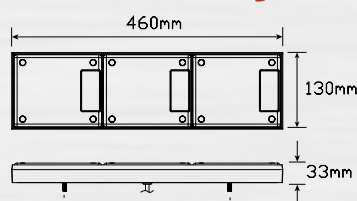

Blister Packaging



Combination Lamps Large Vehicle/Trailer

- Australia's popular jumbo size
- Shock, dust & water proof
- 5 Year warranty



Part Number

J3BARRM - Multivolt 12-24V, Blister single



Part Number

J3BARWM - Multivolt 12-24V, Blister single



Part Number

J3BRRRM - Multivolt 12-24V, Bulk boxed

Function	Stop/Tail/Indicator/Reverse/Reflector	Approvals	Function	Category	CRN	Draw @13.8V	Stop 0.47A	Tail 0.04A	Ind 0.42A	Rev 0.18A
Size	595mm x 130mm x 45mm	ADR	Indicator	6/00/2A	42964	@28V	0.27A	0.03A	0.28A	0.11A
Voltage	Multivolt 12-24V	ADR	Reverse	1/00	42967					
LED Qty	72	ADR	Reflector	47/00	42966					
Cable	1.2 meter cable									

Fitting Instructions

Horizontally or vertically mount using bolts in back of lamp, run wires through hole in fixing surface. Please refer to ADR 13/00 for mounting instructions.

Accessories

- J3RM - Stop/tail
- J3AM - Indicator
- J3WM - Reverse

Technical Drawings

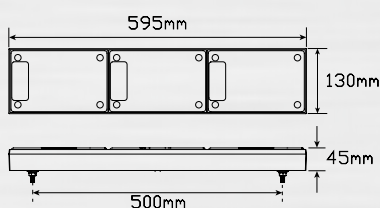

Blister Packaging



Combination Lamps Large Vehicle/Trailer

- Nine individual lens design
- Shock, dust & water proof
- 5 Year warranty



Part Number

J9BARRM - Multivolt 12-24V, Blister single

Function	Stop/Tail/Indicator		
Size	594mm x 130mm x 28mm		
Voltage	Multivolt 12-24V		
LED Qty	324		
Cable	40cm cable		
Draw	Stop	Tail	Indicator
@13.8V	0.32A	0.04A	0.34A
@28V	0.18A	0.04A	0.19A
Approvals	Function	Category	CRN
ADR	Stop/Tail	49/00	35941
ADR	Indicator	6/00/2A	35795



Part Number

J9BARWM - Multivolt 12-24V, Blister single

Function	Stop/Tail/Indicator/Reverse			
Size	594mm x 130mm x 28mm			
Voltage	Multivolt 12-24V			
LED Qty	324			
Cable	40cm cable			
Draw	Stop	Tail	Ind	Rev
@13.8V	0.32A	0.04A	0.34A	0.17A
@28V	0.18A	0.04A	0.19A	0.18A
Approvals	Function	Category	CRN	
ADR	Stop/Tail	49/00	35941	
ADR	Indicator	6/00/2A	35795	
ADR	Reverse	1/00	35796	

Fitting Instructions

Horizontally mount onto flat surface using bolts provided, run wires through back and clip lens into place. Please refer to ADR 13/00.

Accessories

- 200AMB - Indicator
- 200RMB - Stop/tail
- 200WMB - Reverse

Technical Drawings

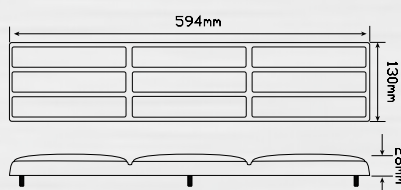

Blister Packaging



Combination Lamps Large Vehicle/Trailer

- Black chrome design
- Shock, dust & water proof
- 7 Year warranty

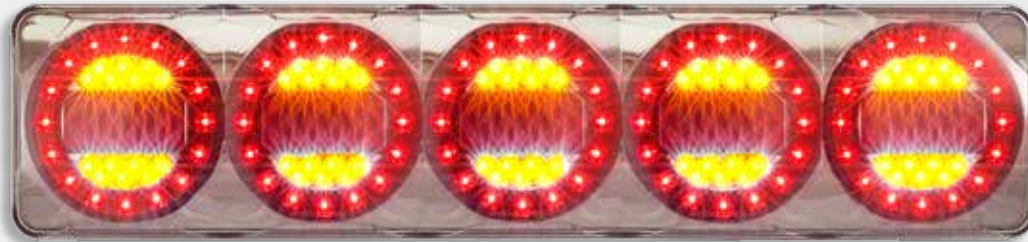

Part Number

MaxilampC5XRR - Multivolt 12-24V, Blister single

Function	Stop/Tail/Indicator/Reflector		
Size	600mm x 135mm x 40mm		
Voltage	Multivolt 12-24V		
LED Qty	150		
Cable	40cm cable		
Draw	Stop	Tail	Ind
@13.8V	1.12A	0.09A	0.62A
@28V	0.73A	0.04A	0.31A
Approvals	Function	Category	CRN
ADR	Stop/Tail	49/00	40966
ADR	Indicator	6/00	40964
ECE	Reflector	02 1A	1472



Part Number

MaxilampC5XRW - Multivolt 12-24V, Blister single

Function	Stop/Tail/Indicator/ Reverse/Reflector			
Size	600mm x 135mm x 40mm			
Voltage	Multivolt 12-24V			
LED Qty	150			
Cable	40cm cable			
Draw	Stop	Tail	Ind	Rev
@13.8V	1.12A	0.08A	0.62A	0.68A
@28V	0.73A	0.04A	0.31A	0.36A
Approvals	Function	Category	CRN	
ADR	Stop/Tail	49/00	40966	
ADR	Indicator	6/00	40964	
ADR	Reverse	1/00	40965	
ECE	Reflector	02 1A	1472	

Fitting Instructions

Horizontally mount onto flat surface using bolts in back of lamp, run wire through hole in fixing surface. Please refer to ADR 13/00 for mounting instructions.

Technical Drawings

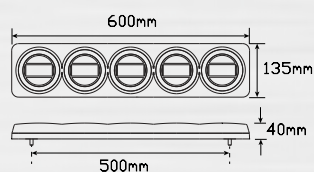

Blister Packaging



Chrome Surround Combination Lamps

- Low profile original design
- Shock, dust & water proof
- 5 Year warranty



Part Number

- 80CSTIM** - Multivolt 12-24V, Blister single
- 80CSTIMB** - Multivolt 12-24V, Bulk boxed
- 80CSTIM6** - Multivolt 12-24V, 6 meter cable, Bulk poly bag

Function	Stop/Tail/Indicator		
Size	100mm x 100mm x 28mm		
Voltage	Multivolt 12-24V		
LED Qty	24		
Cable	40cm cable 6 meter cable		

Draw	Stop	Tail	Indicator
@13.8V	0.33A	0.06A	0.31A
@28V	0.25A	0.04A	0.22A

Approvals	Function	Category	CRN
ADR	Stop	49/00	35788
ADR	Tail	49/00	35789
ADR	Indicator	6/00/2A	35787



Part Number

- 80CAR** - 12 Volt, Blister single
- 80CARM** - Multivolt 12-24V, Blister single

Function	Stop/Tail/Indicator		
Size	188mm x 100mm x 28mm		
Voltage	12 Volt and Multivolt 12-24V		
LED Qty	72		
Cable	40cm cable		

Draw	Stop	Tail	Indicator
@13.8V	0.33A	0.06A	0.31A
@28V	0.25A	0.04A	0.22A

Approvals	Function	Category	CRN
ADR	Stop/Tail	49/00	33059
ADR	Indicator	6/00/2A	33098

Fitting Instructions

Horizontally mount onto flat surface using screws provided, run wires through back and clip lens into place. Please refer to ADR 13/00 for mounting instructions.

Technical Drawings

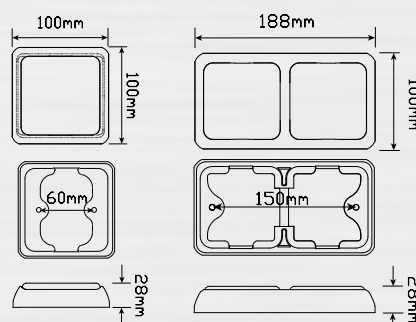

Blister Packaging



Chrome Surround Combination Lamps

- Clip in lens with no visible screws
- Shock, dust & water proof
- 5 Year warranty



Part Number

- 200CSTIM** - Multivolt 12-24V, Blister single
- 200CSTIMB** - Multivolt 12-24V, Bulk boxed

Function	Stop/Tail/Indicator		
Size	200mm x 50mm x 28mm		
Voltage	Multivolt 12-24V		
LED Qty	24		
Cable	40cm cable		
Draw	Stop	Tail	Indicator
@13.8V	0.29A	0.09A	0.19A
@28V	0.16A	0.07A	0.07A
Approvals	Function	Category	CRN
ADR	Stop	49/00	35785
ADR	Tail	49/00	35786
ADR	Indicator	6/00/2A	35784



Part Number

- 200CSTIRMB** - Multivolt 12-24V, Bulk boxed
- 200CSTIR48** - 48 Volt, Bulk boxed

Function	Stop/Tail/Indicator/Reverse			
Size	200mm x 50mm x 28mm			
Voltage	Multivolt 12-24V or 48V			
LED Qty	24			
Cable	40cm cable			
Draw	Stop	Tail	Ind	Rev
@13.8V	0.10A	0.02A	0.11A	0.10A
@28V	0.08A	0.40A	0.08A	0.08A
@48V	0.41A	0.11A	0.40A	0.28A
Approvals	Non ADR/ECE approved			



Part Number

- 201CSTI2** - 12 Volt, Blister twin
- 201CSTIM** - Multivolt 12-24V, Blister single
- 201CSTIMB** - Multivolt 12-24V, Bulk boxed

Function	Stop/Tail/Indicator		
Size	200mm x 50mm x 28mm		
Voltage	12 Volt or Multivolt 12-24V		
LED Qty	16		
Cable	40cm cable		
Draw	Stop	Tail	Ind
@13.8V	0.13A	0.02A	0.13A
@28V	0.40A	0.03A	0.40A
Approvals	Function	Category	CRN
ADR	Stop	49/00	TBA
ADR	Tail	49/00	TBA
ADR	Indicator	6/00/2A	TBA

Fitting Instructions

Horizontally mount onto flat surface using screws provided, run wires through back and clip lens into place. Please refer to ADR 13/00.

Technical Drawings

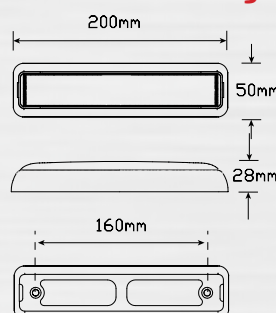

Blister Packaging



Chrome Surround Combination Lamps

- Clip in lens with no visible screws
- Shock, dust & water proof
- 5 Year warranty

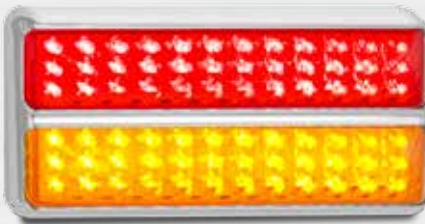

Part Number
200CARM - Multivolt 12-24V, Blister single

Function	Stop/Tail/Indicator		
Size	200mm x 92mm x 28mm		
Voltage	Multivolt 12-24V		
LED Qty	72		
Cable	40cm cable		
Draw	Stop	Tail	Indicator
@13.8V	0.32A	0.04A	0.34A
@28V	0.18A	0.04A	0.19A
Approvals	Function	Category	CRN
ADR	Stop/Tail	49/00	35941
ADR	Indicator	6/00/2A	35795

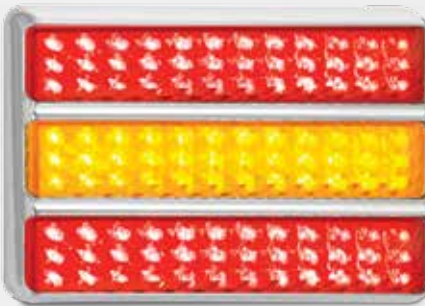

Part Number
200CARRM - Multivolt 12-24V, Blister single

Function	Stop/Tail/Indicator		
Size	200mm x 134mm x 28mm		
Voltage	Multivolt 12-24V		
LED Qty	108		
Cable	40cm cable		
Draw	Stop	Tail	Indicator
@13.8V	0.32A	0.04A	0.34A
@28V	0.18A	0.04A	0.19A
Approvals	Function	Category	CRN
ADR	Stop/Tail	49/00	35941
ADR	Indicator	6/00/2A	35795



Part Number
200CARWM - Multivolt 12-24V, Blister single

Function	Stop/Tail/Indicator/Reverse			
Size	200mm x 134mm x 28mm			
Voltage	Multivolt 12-24V			
LED Qty	97			
Cable	40cm cable			
Draw	Stop	Tail	Ind	Rev
@13.8V	0.32A	0.04A	0.34A	0.17A
@28V	0.18A	0.04A	0.19A	0.18A
Approvals	Function	Category	CRN	
ADR	Stop/Tail	49/00	35941	
ADR	Indicator	6/00/2A	35795	
ADR	Reverse	1/00	35796	

Fitting Instructions

Horizontally mount onto flat surface using bolts provided, run wires through back and clip lens into place. Please refer to ADR 13/00.

Accessories

200AMB - Indicator
200RMB - Stop/tail
200WMB - Reverse

Technical Drawings

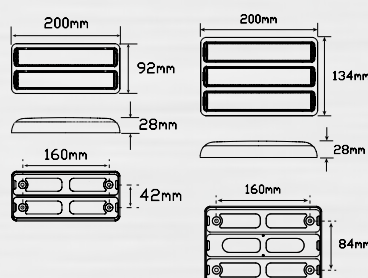

Blister Packaging



Chrome Surround Combination Lamps

- Surface mounted low profile
- Shock, dust & water proof
- 5 Year warranty



Part Number
235CAR12 - 12 Volt, Blister single

Function	Stop/Tail/Indicator		
Size	258mm x 82mm x 17mm		
Voltage	12 Volt		
LED Qty	20		
Cable	40cm cable		
Draw	Stop	Tail	Indicator
@13.8V	0.14A	0.04A	0.16A
@28V	0.13A	0.05A	0.12A
Approvals	Function	Category	CRN
ADR	Stop/Tail	49/00	37678
	Indicator	6/00/2A	39092



Part Number
380CAR12 - 12 Volt, Blister single
380CAR24 - 24 Volt, Blister single

Function	Stop/Tail/Indicator		
Size	428mm x 97mm x 22mm		
Voltage	12 Volt or 24 Volt		
LED Qty	36		
Cable	40cm cable		
Draw	Stop	Tail	Ind
@13.8V	0.16A	0.04A	0.18A
@28V	0.12A	0.01A	0.10A
Compliance	Function	Category	CRN
ADR	Stop/Tail	49/00	39473
	Indicator	6/00CAT2A	39470

Fitting Instructions

Horizontally mount onto flat surface using screws provided. Please refer to ADR 13/00 for mounting instructions.

Technical Drawings

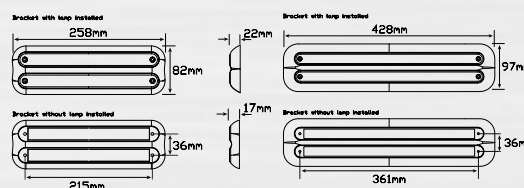

Blister Packaging



Chrome Surround Combination Lamps

- Individual lens replacements
- Shock, dust & water proof
- 5 Year warranty



Part Number

- 80CARR** - 12 Volt, Blister single
- 80CARRM** - Multivolt 12-24V, Blister single

Function	Stop/Tail/Indicator		
Size	278mm x 100mm x 28mm		
Voltage	12 Volt and Multivolt 12-24V		
LED Qty	108		
Cable	40cm cable		
Draw	Stop	Tail	Indicator
@13.8V	0.33A	0.06A	0.29A
@28V	0.25A	0.04A	0.22A
Approvals	Function	Category	CRN
ADR	Stop/Tail	49/00	33059
ADR	Indicator	6/00/2A	33098

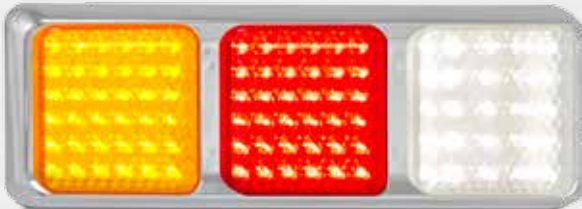

Part Number

- 80CARW** - 12 Volt, Blister single
- 80CARWM** - Multivolt 12-24V, Blister single

Function	Stop/Tail/Indicator/Reverse			
Size	278mm x 100mm x 28mm			
Voltage	12 Volt and Multivolt 12-24V			
LED Qty	97			
Cable	40cm cable			
Draw	Stop	Tail	Ind	Rev
@13.8V	0.33A	0.06A	0.29A	0.17A
@28V	0.25A	0.04A	0.22A	0.21A
Approvals	Function	Category	CRN	
ADR	Stop/Tail	49/00	33059	
ADR	Indicator	6/00/2A	33098	
ADR	Reverse	1/00	35797	

Fitting Instructions

Horizontally mount onto flat surface using screws provided, run wires through back and clip lens into place. Please refer to ADR 13/00

Accessories

- 80AMB - Indicator
- 80RMB - Stop/tail
- 80WMB - Reverse

Technical Drawings

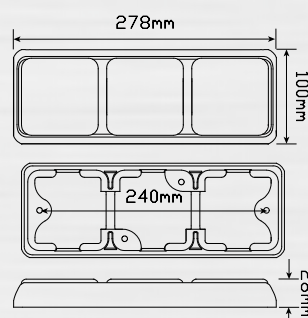

Blister Packaging



Chrome Surround Combination Lamps

- Individual lens replacements
- Shock, dust & water proof
- 5 Year warranty



Part Number
100CARRM - Multivolt 12-24V, Blister single

Function	Stop/Tail/Indicator		
Size	350mm x 120mm x 31mm		
Voltage	Multivolt 12-24V		
LED Qty	147		
Cable	40cm cable		
Draw	Stop	Tail	Indicator
@13.8V	0.38A	0.04A	0.38A
@28V	0.24A	0.07A	0.23A
Approvals	Function	Category	CRN
ADR	Stop/Tail	49/0	33402
ADR	Indicator	6/00/2A	33156



Part Number
100CARWM - Multivolt 12-24V, Blister single

Function	Stop/Tail/Indicator/Reverse			
Size	350mm x 120mm x 31mm			
Voltage	Multivolt 12-24V			
LED Qty	123			
Cable	40cm cable			
Draw	Stop	Tail	Ind	Rev
@13.8V	0.38A	0.04A	0.38A	0.31A
@28V	0.24A	0.07A	0.23A	0.17A
Approvals	Function	Category	CRN	
ADR	Stop/Tail	49/00	33402	
ADR	Indicator	6/00/2A	33156	
ADR	Reverse	1/00	35793	

Fitting Instructions

Horizontally mount onto flat surface using screws provided, run wires through back and clip lens into place. Please refer to ADR 13/00 for mounting instructions.

Accessories

- 100AMB - Indicator
- 100RMB - Stop/tail
- 100WMB - Reverse

Technical Drawings

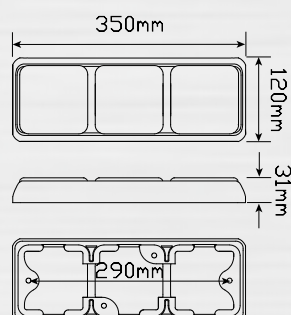

Blister Packaging



Chrome Surround Combination Lamps

- Black chrome design
- Shock, dust & water proof
- 7 Year warranty



Part Number

MaXilampC3XR - Multivolt 12-24V, Blister single

MaXilampC3XRB - Multivolt 12-24V, Bulk boxed

Function	Stop/Tail/Indicator/Reflector		
Size	370mm x 135mm x 40mm		
Voltage	Multivolt 12-24V		
LED Qty	90		
Cable	40cm cable		

Draw	Stop	Tail	Ind
@13.8V	0.54A	0.08A	0.77A
@28V	0.27A	0.04A	0.35A

Approvals	Function	Category	CRN
ADR	Stop/Tail	49/00	40963
ADR	Indicator	06/00	40962
ECE	Reflector	02 1A	1472



Part Number

MaXilampC3XRW - Multivolt 12-24V, Blister single

MaXilampC3XRWB - Multivolt 12-24V, Bulk boxed

Function	Stop/Tail/Indicator/Reverse/Reflector			
Size	370mm x 135mm x 40mm			
Voltage	Multivolt 12-24V			
LED Qty	90			
Cable	40cm cable			

Draw	Stop	Tail	Ind	Rev
@13.8V	0.54A	0.08A	0.77A	0.67A
@28V	0.27A	0.04A	0.35A	0.34A

Approvals	Function	Category	CRN
ADR	Stop/Tail	49/00	40963
ADR	Indicator	6/00	40962
ADR	Reverse	1/00	40961
ECE	Reflector	02 1A	1472

Fitting Instructions

Horizontally mount onto flat surface with stainless steel bolts provided in assembly and run cable through 12mm hole. Please refer to ADR 13/00 for mounting instructions.

Technical Drawings

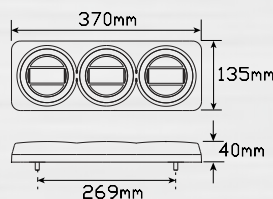

Blister Packaging



Chrome Surround Combination Lamps

- Individual lens replacements
- Shock, dust & water proof
- 5 Year warranty



Part Number
125CARRM - Multivolt 12-24V, Blister single

Function	Stop/Tail/Indicator		
Size	435mm x 146mm x 31mm		
Voltage	Multivolt 12-24V		
LED Qty	192		
Cable	40cm cable		
Draw	Stop	Tail	Indicator
@13.8V	0.42A	0.04A	0.43A
@28V	0.26A	0.06A	0.25A
Approvals	Function	Category	CRN
ADR	Stop/Tail	49/00	33403
ADR	Indicator	6/00/2A	33165



Part Number
125CARWM - Multivolt 12-24V, Blister single

Function	Stop/Tail/Indicator/Reverse			
Size	435mm x 146mm x 31mm			
Voltage	Multivolt 12-24V			
LED Qty	153			
Cable	40cm cable			
Draw	Stop	Tail	Ind	Rev
@13.8V	0.42A	0.04A	0.43A	0.36A
@28V	0.26A	0.06A	0.25A	0.18A
Approvals	Function	Category	CRN	
ADR	Stop/Tail	49/00	33403	
ADR	Indicator	6/00/2A	33165	
ADR	Reverse	1/00	35794	

Fitting Instructions

Horizontally mount onto flat surface using screws provided. Please refer to ADR 13/00 for mounting instructions.

Accessories

- 125AMB - Indicator
- 125RMB - Stop/tail
- 125WMB - Reverse

Technical Drawings

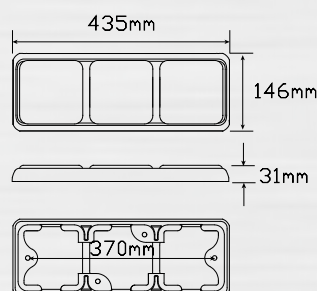

Blister Packaging



Chrome Surround Combination Lamps

- Nine individual lens design
- Shock, dust & water proof
- 5 Year warranty



Part Number

J9CARRM - Multivolt 12-24V, Blister single

Function	Stop/Tail/Indicator		
Size	594mm x 130mm x 28mm		
Voltage	Multivolt 12-24V		
LED Qty	324		
Cable	40cm cable		
Draw	Stop	Tail	Indicator
@13.8V	0.32A	0.04A	0.34A
@28V	0.18A	0.04A	0.19A
Approvals	Function	Category	CRN
ADR	Stop/Tail	49/00	35941
ADR	Indicator	6/00/2A	35795



Part Number

J9CARWM - Multivolt 12-24V, Blister single

Function	Stop/Tail/Indicator/Reverse			
Size	594mm x 130mm x 28mm			
Voltage	Multivolt 12-24V			
LED Qty	324			
Cable	40cm cable			
Draw	Stop	Tail	Ind	Rev
@13.8V	0.32A	0.04A	0.34A	0.17A
@28V	0.18A	0.04A	0.19A	0.18A
Approvals	Function	Category	CRN	
ADR	Stop/Tail	49/00	35941	
ADR	Indicator	6/00/2A	35795	
ADR	Reverse	1/00	35796	

Fitting Instructions

Horizontally mount onto flat surface with bolts provided, run wires through back and clip lens into place. Please refer to ADR 13/00.

Accessories

- J9B9B - Black Bracket
- J9B9C - Chrome Bracket

Technical Drawings

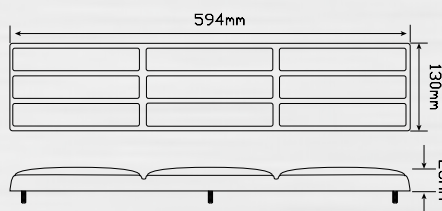

Blister Packaging



Combination Lamps Large Vehicle/Trailer

- Black chrome design
- Shock, dust & water proof
- 7 Year warranty

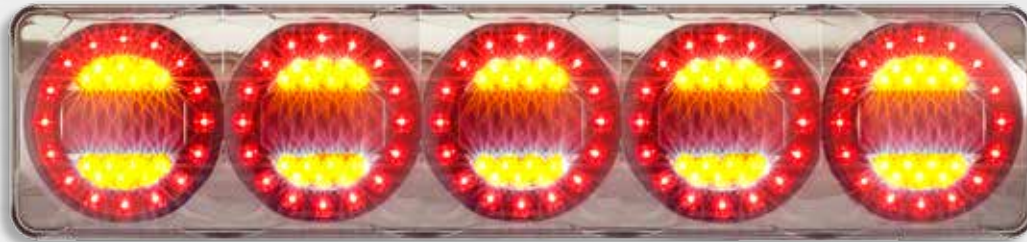

Part Number

MaxilampC5XRR - Multivolt 12-24V, Blister single

Function	Stop/Tail/Indicator/Reflector		
Size	600mm x 135mm x 40mm		
Voltage	Multivolt 12-24V		
LED Qty	150		
Cable	40cm cable		
Draw	Stop	Tail	Ind
@13.8V	1.12A	0.09A	0.62A
@28V	0.73A	0.04A	0.31A
Approvals	Function	Category	CRN
ADR	Stop/Tail	49/00	40966
ADR	Indicator	6/00	40964
ECE	Reflector	02 1A	1472



Part Number

MaxilampC5XRW - Multivolt 12-24V, Blister single

Function	Stop/Tail/Indicator/Reverse/Reflector			
Size	600mm x 135mm x 40mm			
Voltage	Multivolt 12-24V			
LED Qty	150			
Cable	40cm cable			
Draw	Stop	Tail	Ind	Rev
@13.8V	1.12A	0.08A	0.62A	0.68A
@28V	0.73A	0.04A	0.31A	0.36A
Approvals	Function	Category	CRN	
ADR	Stop/Tail	49/00	40966	
ADR	Indicator	6/00	40964	
ADR	Reverse	1/00	40965	
ECE	Reflector	02 1A	1472	

Fitting Instructions

Horizontally mount onto flat surface using bolts in back of lamp, run wire through hole in fixing surface. Please refer to ADR 13/00 for mounting instructions.

Technical Drawings

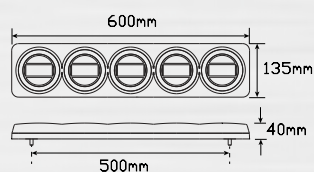

Blister Packaging



Clear Lens Chrome Surround Combination Lamps

- Surface mounted low profile
- Shock, dust & water proof
- 5 Year warranty

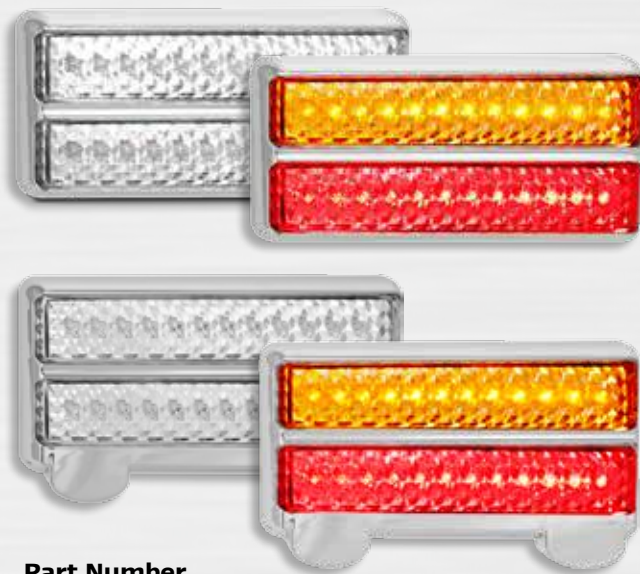

Part Number
200CCARLPM2 - Multivolt 12-24V, LHS/RHS Blister twin pack

- This product is only available in a twin pack
- The twin pack includes 200CARM

Function	Stop/Tail/Indicator and Stop/Tail/Indicator/Licence			
Size	200mm x 92mm x 28mm			
Voltage	Multivolt 12-24V			
LED Qty	24, 4 (Licence)			
Cable	40cm cable with plug			
Draw	Stop	Tail	Ind	Lic
@13.8V	0.18A	0.07A	0.17A	0.02A
@28V	0.32A	0.04A	0.39A	0.02A
Approvals	Function	Category	CRN	
ADR	Stop/Tail	49/00	35941	
ADR	Indicator	6/00/2A	35795	
ADR	Licence	47/00	37844	

Fitting Instructions

Horizontally mount onto flat surface with bolts provided. Please refer to ADR 13/00 for mounting instructions.

Technical Drawings

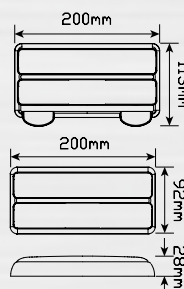

Blister Packaging



Clear Lens Chrome Surround Combination Lamps

- Surface mounted low profile
- Shock, dust & water proof
- 5 Year warranty



Part Number

235CWSTI12 - 12 Volt, White PCB, Blister single

235CWSTI24 - 24 Volt, White PCB, Chrome bracket, Bulk boxed

Function	Stop/Tail/Indicator		
Size	259mm x 46mm x 17mm		
Voltage	12 Volt		
LED Qty	12		
Cable	40cm cable		

Draw	Stop	Tail	Indicator
@13.8V	0.17A	0.02A	0.17A

Approvals	Function	Category	CRN
ADR	Stop/Tail	49/00	TBA
ADR	Indicator	6/00	TBA



Part Number

235CCAR12 - 12 Volt, Blister single

Function	Stop/Tail/Indicator		
Size	258mm x 82mm x 17mm		
Voltage	12 Volt		
LED Qty	20		
Cable	40cm cable		

Draw	Stop	Tail	Indicator
@13.8V	0.14A	0.04A	0.16A

Approvals	Function	Category	CRN
ADR	Stop/Tail	49/00	37678
	Indicator	6/00/2A	39092

Fitting Instructions

Horizontally mount onto flat surface with screws provided. Please refer to ADR 13/00 for mounting instructions.

Technical Drawings

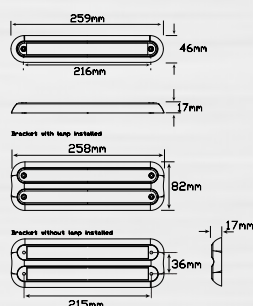

Blister Packaging



Clear Lens Chrome Surround Combination Lamps

- Clip in lens with no visible screws
- Shock, dust & water proof
- 5 Year warranty



Part Number
200CCARM - Multivolt 12-24V, Blister single

Function	Stop/Tail/Indicator		
Size	200mm x 92mm x 28mm		
Voltage	Multivolt 12-24V		
LED Qty	24		
Cable	40cm cable		
Draw	Stop	Tail	Indicator
@13.8V	0.32A	0.04A	0.34A
@28V	0.18A	0.04A	0.19A
Approvals	Function	Category	CRN
ADR	Stop/Tail	49/00	35941
ADR	Indicator	6/00/2A	35795



Part Number
200CCARRM - Multivolt 12-24V, Blister single

Function	Stop/Tail/Indicator		
Size	200mm x 134mm x 28mm		
Voltage	Multivolt 12-24V		
LED Qty	36		
Cable	40cm cable		
Draw	Stop	Tail	Indicator
@13.8V	0.32A	0.04A	0.34A
@28V	0.18A	0.04A	0.19A
Approvals	Function	Category	CRN
ADR	Stop/Tail	49/00	35941
ADR	Indicator	6/00/2A	35795



Part Number
200CCARWM - Multivolt 12-24V, Blister single

Function	Stop/Tail/Indicator/Reverse			
Size	200mm x 134mm x 28mm			
Voltage	Multivolt 12-24V			
LED Qty	36			
Cable	40cm cable			
Draw	Stop	Tail	Ind	Rev
@13.8V	0.32A	0.04A	0.34A	0.17A
@28V	0.18A	0.04A	0.19A	0.18A
Approvals	Function	Category	CRN	
ADR	Stop/Tail	49/00	35941	
ADR	Indicator	6/00/2A	35795	
ADR	Reverse	1/00	35796	

Fitting Instructions

Horizontally mount onto flat surface with bolts provided, run wires through back and clip lens into place. Please refer to ADR 13/00.

Technical Drawings

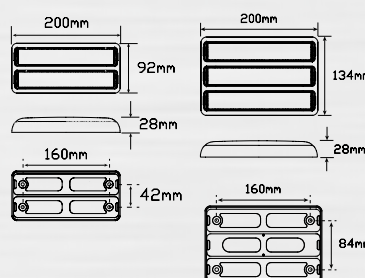

Blister Packaging



Clear Lens Chrome Surround Combination Lamps

- Nine individual lens design
- Shock, dust & water proof
- 5 Year warranty

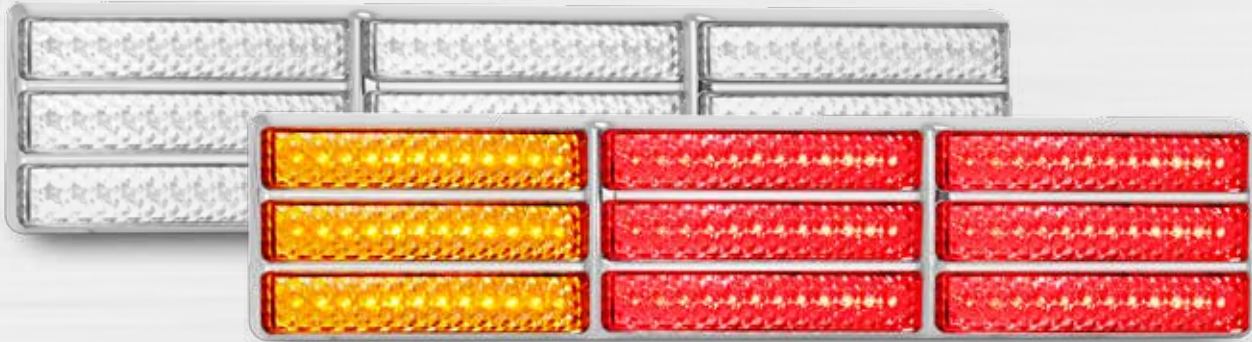

Part Number

J9CCARRM - Multivolt 12-24V, Blister single

Function Stop/Tail/Indicator
Size 594mm x 130mm x 28mm
Voltage Multivolt 12-24V
LED Qty 108
Cable 40cm cable

Draw	Stop	Tail	Indicator
@13.8V	0.32A	0.04A	0.34A
@28V	0.18A	0.04A	0.19A

Approvals	Function	Category	CRN
ADR	Stop/Tail	49/00	35941
ADR	Indicator	6/00/2A	35795



Part Number

J9CCARWM - Multivolt 12-24V, Blister single

Function Stop/Tail/Indicator/Reverse
Size 594mm x 130mm x 28mm
Voltage Multivolt 12-24V
LED Qty 108
Cable 40cm cable

Draw	Stop	Tail	Ind	Rev
@13.8V	0.32A	0.04A	0.34A	0.17A
@28V	0.18A	0.04A	0.19A	0.18A

Approvals	Function	Category	CRN
ADR	Stop/Tail	49/00	35941
ADR	Indicator	6/00/2A	35795
ADR	Reverse	1/00	35796

Fitting Instructions

Horizontally mount onto flat surface with bolts provided, run wires through back and clip lens into place. Please refer to ADR 13/00.

Technical Drawings

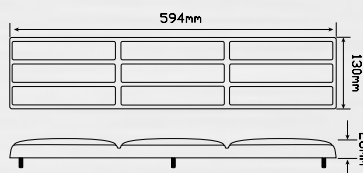

Blister Packaging



Front indicator

- Low profile design
- Shock, dust & water proof
- 5 Year warranty



Part Number

- 135CAT1** - 12 Volt, Blister single
- 135CAT124** - 24 Volt, Blister single
- 135CAT1B** - 12 Volt, Bulk poly bag
- 135CAT124B** - 24 Volt, Bulk poly bag

Function Front Indicator Lamp
Size 135mm x 38mm x 24mm
 145mm x 48mm x 10mm
Voltage 12 Volt or 24 Volt
LED Qty 18
Cable 40cm cable

Draw
@13.8V 0.39A
@28V 0.17A

Approvals	Function	Category	CRN
ADR	12V Ind	6/00/1	39340
ADR	24V Ind	6/00/1	42131



Part Number

- 135CAT1G** - 12 Volt, Blister single



Part Number

- 235CAT1B** - 12 Volt, Bulk boxed
- 235CAT1-24B** - 24 Volt, Bulk boxed

Function Front Indicator
Size 237mm x 25mm x 3mm
Voltage 12 Volt or 24 Volt
LED Qty 10
Cable 40cm cable

Draw
@13.8V 0.19A
@28V 0.10A

Approvals	Function	Category	CRN
ADR	Indicator	6/00/1	44226



Available as surface mount with black, chrome or white brackets.

Fitting Instructions

135CAT1 - Horizontally mount onto flat surface & clip lens into place.

135CAT1G - Recess mount grommet (cut out for grommet 133mm x 36mm) horizontally to the ground & push lens into place.

235CAT1 - Recess mount grommet (cut out 203mm x 19mm) horizontally to the ground & push lens into place. Refer to ADR 13/00 for mounting instructions.

Technical Drawings

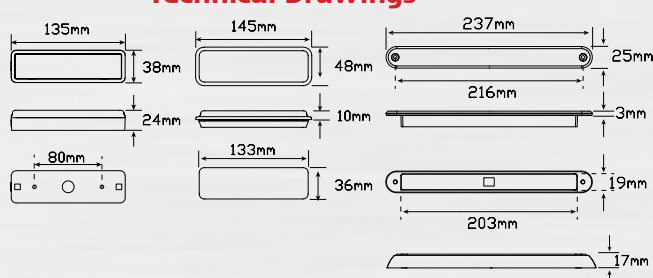

Blister Packaging



Front indicator

- Retro fit to existing 4x4
- 5 Year warranty
- ADR approved



Part Number

175AW - 12 Volt, straight bull bars, Blister single

176AW - 12 Volt, angled bull bars, Blister single

Two versions available, standard version and LEDs at 24° for bullbars that are curved at 24°

Function Front Indicator/Marker lamp
horizontal mount
Straight or 24°
angled mount

Size 175mm x 50mm x 24mm

Voltage 12 Volt

LED Qty 25

Cable 40cm cable

Draw **Indicator** **Position**

@13.8V 0.32A 0.03A

Approvals **Function** **Category** **CRN**

ADR (175) Indicator 6/00/1 42822

ADR (175) Position 49/00 42821

ADR (176) Indicator 6/00/1 43995

ADR (176) Position 49/00 43996



Part Number

200CAW - 12 Volt, Bulk boxed

200CAW/24 - 24 Volt, Bulk boxed

Function Front Indicator/Marker Lamp

Size 200mm x 50mm x 28mm

Voltage 12 Volt or 24 Volt

LED Qty 29

Cable 40cm cable

Draw **Indicator** **Position**

@13.8V 0.12A 0.01A

@28V 0.08A 0.02A

Approvals **Function** **Category** **CRN**

ADR Indicator 6/00/1 38794

ADR Position 49/00 38795

Fitting Instructions

Horizontally mount onto flat surface and clip lens into place. Please refer to ADR 13/00 for mounting instructions

Technical Drawings

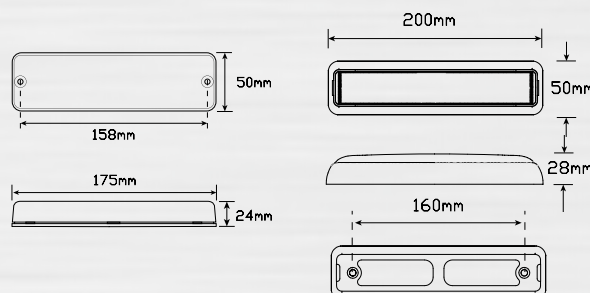

Blister Packaging



Front Indicator/ Daytime Running Lamp

- Retro fit to existing 4x4 bullbar
- 5 Year warranty
- ADR approved



Part Number

- 80AW** - 12 Volt, Blister single
80AWB - 12 Volt, Bulk boxed

Function	Front Indicator/Marker Lamp	
Size	80mm round x 40mm	
Voltage	12 Volt	
LED Qty	34	
Cable	40cm cable	

Draw	Indicator	Position
@13.8V	0.32A	0.03A

Approvals	Function	Category	CRN
ADR	Indicator	6/00/1	TBA
ADR	Position	49/00	TBA

Daytime running accessory function when used in conjunction with Part Number: DRLHOTDOG



Daytime running lamps

The increased presence of daytime running lights on our roads has caused some confusion within the community due to the outwardly similar appearances between daytime running lights, driving lights and fog lights. The purpose of daytime running lights is to increase the visibility of a vehicle to other road users in daylight conditions.

The results of European studies have shown that daytime running lights assist road users to easily recognise and identify vehicles. As a result, a European Commission Directive mandated the addition of daytime running lights to new vehicles from 2011. A number of European manufacturers have brought these vehicles to Australia.



Function	Front Indicator/marker daytime running lamp		
Size	225mm x 50mm x 28mm		
Voltage	12 Volt		
LED Qty	39		
Cable	40cm cable		

Draw	Indicator	Position	DRL
@13.8V	0.26A	0.02A	0.22A

Approvals	Function	Category	CRN
ADR	Indicator	6/00CAT1	TBA
ADR	Position	49/00	TBA
ADR	Daytime	45/01	TBA

Daytime running accessory function when used in conjunction with Part Number: DRLHOTDOG



Part Number

- 175AWDRL** - 12 Volt, Blister single
175AWDRLB - 12 Volt, Bulk boxed

Fitting Instructions

Retro fit to existing bullbar applications. Please refer to ADR 13/00 for mounting instructions.

Accessories

DRLHOTDOG



Technical Drawings

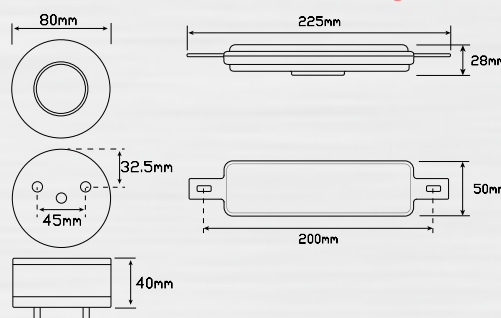

Blister Packaging



Side Direction Indicators

- Side direction indicator
- Category 5 and 6 approved
- 5 Year warranty



Part Number

170CAT5 - 12 Volt, Blister single

170CAT5/24 - 24 Volt, Bulk boxed

Suits M2-3, N1 class vehicles under 6 meters

Function	Side direction indicator/marker Category 5		
Size	170mm x 68mm x 32mm		
Voltage	12 Volt or 24 Volt		
LED Qty	15		
Cable	21cm cable		
Draw	@13.8V	@28V	
	0.265A	0.12A	

Approvals	Function	Category	CRN
ADR	Side	6/00 /5	TBA
ADR	Marker	74/00	TBA



Part Number

3102BM - Multivolt 9-33V, Bulk boxed

Suits M2-3, N1 class vehicles over 6 meters
All N2-N3 class vehicles



Function	Side direction indicator Category 6		
Size	150mm x 88mm x 30mm		
Voltage	Multivolt 9-33V		
LED Qty	12		
Cable	19cm cable		
Draw	@13.8V	@28V	
	0.02A	0.10A	

Approvals	Function	Category	CRN
ECE	Side	6 01 E4	61333

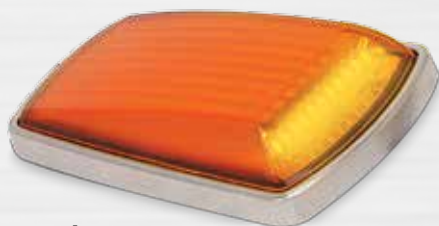

Part Number

3102CM - Multivolt 9-33V, Bulk boxed

Suits M2-3, N1 class vehicles over 6 meters
All N2-N3 class vehicles

Function	Side direction indicator Category 6		
Size	150mm x 88mm x 30mm		
Voltage	Multivolt 9-33V		
LED Qty	12		
Cable	19cm cable		
Draw	@13.8V	@28V	
	0.02A	0.10A	

Approvals	Function	Category	CRN
ECE	Side	6 01 E4	61333

Fitting Instructions

170CAT5 Series

Remove bezel from assembly and surface mount horizontally to ground using screws included, then refit bezel. ADR 13/00

3102 Series

Left or right hand mountable. Surface mount bracket onto flat surface horizontally to the ground using three screw points, run wires through back and clip lens into place. Please refer to ADR 13/00 for mounting instructions.

Technical Drawings

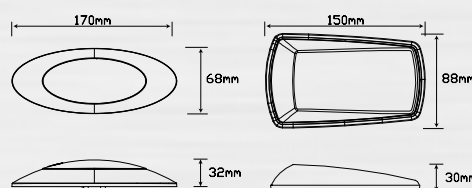

Blister Packaging



Hazard Warning Emergency Lamps

- Strobe or constant function
- Shock, dust & water proof
- 3 Year warranty



Part Number
93RM - Multivolt 12-24V, Bulk boxed



Part Number
93AM - Multivolt 12-24V, Bulk boxed



Part Number
93BM - Multivolt 12-24V, Bulk boxed



Part Number
93GM - Multivolt 12-24V, Bulk boxed



Part Number
93WM - Multivolt 12-24V, Bulk boxed

Function Emergency lamp with synchronising wire
Size 93mm x 36mm x 25mm
Voltage Multivolt 12-24V
LED Qty 3 x 1 Watt
Flash Rate 6 Flashes every 0.3 sec
Cable 19cm cable

Draw	Lamp	Constant	Strobe
@13.8V	93RM	0.11A	0.10-0.34A
@28V	93RM	0.06A	0.01-0.19A
@13.8V	93AM	0.11A	0.10-0.34A
@28V	93AM	0.06A	0.01-0.19A
@13.8V	93BM	0.08A	0.02-0.20A
@28V	93BM	0.05A	0.01-0.12A
@13.8V	93GM	0.13A	0.01-0.42A
@28V	93GM	0.08A	0.01-0.23A
@13.8V	93WM	0.09A	0.02-0.21A
@28V	93WM	0.05A	0.02-0.13A

Function Emergency lamp with synchronising wire
Size 93mm x 36mm x 25mm
Voltage Multivolt 12-24V
LED Qty 3 x 1 Watt
Flash Rate 6 Flashes every 0.3 sec
Cable 19cm cable

Draw	Lamp	Constant	Strobe
@13.8V	93RM	0.11A	0.10-0.34A
@28V	93RM	0.06A	0.01-0.19A
@13.8V	93AM	0.11A	0.10-0.34A
@28V	93AM	0.06A	0.01-0.19A
@13.8V	93BM	0.08A	0.02-0.20A
@28V	93BM	0.05A	0.01-0.12A
@13.8V	93GM	0.13A	0.01-0.42A
@28V	93GM	0.08A	0.01-0.23A
@13.8V	93WM	0.09A	0.02-0.21A
@28V	93WM	0.05A	0.02-0.13A

Fitting instructions

Horizontally mount onto flat surface with screws provided using flange and foam gasket.

Technical drawings

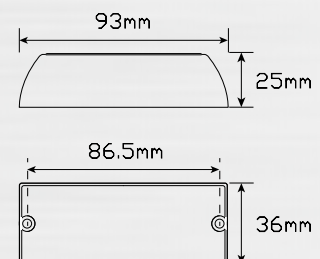

Hazard Warning Emergency Lamps

- Various flash pattern 180°
- 12 Strobe function, synchronised
- 3 Year warranty



Part Number

90RM - Multivolt 12-24V, Bulk boxed



Part Number

90AM - Multivolt 12-24V, Bulk boxed



Part Number

90BM - Multivolt 12-24V, Bulk boxed



Part Number

90WM - Multivolt 12-24V, Bulk boxed



Side view of lamp

Function Emergency lamp with synchronising wire
12 Strobe patterns

Size 112mm x 37mm x 23mm

Voltage Multivolt 12-24V

LED Qty 3 x 1 Watt

Flash Rate Multiple

Cable 18cm cable

Draw	Lamp	Strobe
@13.8V	90RM	0.01-0.15A
@28V	90RM	0.03-0.06A
@13.8V	90AM	0.01-0.15A
@28V	90AM	0.03-0.06A
@13.8V	90BM	0.08-0.16A
@28V	90BM	0.02-0.12A
@13.8V	90WM	0.01-0.20A
@28V	90WM	0.01-0.19A

Function Emergency lamp with synchronising wire
12 Strobe patterns

Size 112mm x 37mm x 23mm

Voltage Multivolt 12-24V

LED Qty 3 x 1 Watt

Flash Rate Multiple

Cable 18cm cable

Draw	Lamp	Strobe
@13.8V	90RM	0.01-0.15A
@28V	90RM	0.03-0.06A
@13.8V	90AM	0.01-0.15A
@28V	90AM	0.03-0.06A
@13.8V	90BM	0.08-0.16A
@28V	90BM	0.02-0.12A
@13.8V	90WM	0.01-0.20A
@28V	90WM	0.01-0.19A

Fitting instructions

Fix to flat surface at two fixing points.

Technical drawings

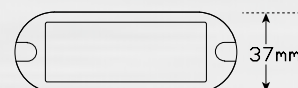
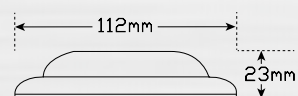

Hazard Warning Emergency Lamps

- Various pattern strobe
- Shock, dust & water proof
- 3 Year warranty

IP 67
TESTED

12 & 24
MULTIVOLT



Part Number
94RM - Multivolt 12-24V, Bulk boxed



Part Number
94AM - Multivolt 12-24V, Bulk boxed



Part Number
94BM - Multivolt 12-24V, Bulk boxed



Part Number
94WM - Multivolt 12-24V, Bulk boxed

Function	Emergency lamp 18 Strobe patterns
Size	72mm x 72mm x 28mm
Voltage	Multivolt 12-24V
LED Qty	4
Flash Rate	6 Flashes every 0.3 sec
Cable	25cm cable

Draw	Lamp	Constant	Strobe
@13.8V	94RM	0.11A	0.10-0.34A
@28V	94RM	0.06A	0.10-0.16A
@13.8V	94AM	0.11A	0.10-0.34A
@28V	94AM	0.06A	0.10-0.16A
@13.8V	94BM	0.08A	0.02-0.20A
@28V	94BM	0.05A	0.01-0.12A
@13.8V	94WM	0.09A	0.02-0.21A
@28V	94WM	0.05A	0.02-0.13A

Fitting instructions

Fix to mounting surface using adjustable U bracket, bolts and fittings supplied.

Technical drawings

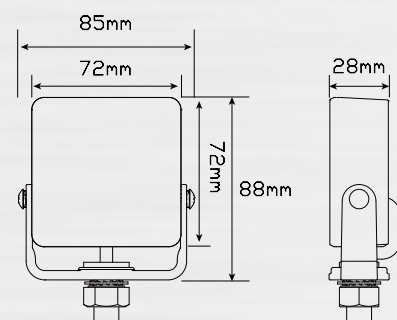

Hazard Warning Strobe Beacons

- 10-110 Volt Mini beacon
- Shock, dust & water proof
- 3 Year warranty



Smallest beacon in the market



Part Number

MB12AM - Multivolt 10-110V
Amber lens, Blister single



Part Number

MB12AMC - Multivolt 10-110V
Clear lens, Blister single

Function	Amber mini strobe beacon SAE Approved	
Size	64mm round x 96mm	
Voltage	Multivolt 10-110V	
LED Qty	12 x 1 Watt	
Flash Rate	45 flashes per min	
Cable	40cm cable	
Draw	Peak	
@13.8V	1.00A	
@28V	1.00A	
Approvals	Function	Category
SAE	Beacon	SAE J85 Class 1

Smallest R65 beacon in the world



Part Number

MB12AME - Multivolt 10-110V
Amber lens, Blister single



Part Number

MB12AMCE - Multivolt 10-110V
Clear lens, Blister single

Function	Amber mini strobe beacon R65 Approved	
Size	64mm round x 96mm	
Voltage	Multivolt 10-110V	
LED Qty	12 x 1 Watt	
Flash Rate	120-140 flashes per min	
Cable	40cm cable	
Draw	Peak	
@13.8V	1.00A	
@28V	1.00A	
Approvals	Function	Category
ECE	Beacon	R65

Fitting instructions

Fit to flat surface using screws at two fixing points supplied.

Technical drawings

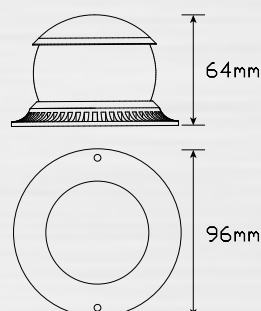

Blister Packaging



Hazard Warning Strobe Beacons

- High powered GIII LEDs
- Shock, dust & water proof
- 5 Year warranty

IP 67
TESTED

10-110v
MULTIVOLT



Part Number
111AM - Multivolt 10-36V, Blister single

Function	Strobe beacon
Size	64mm round x 111mm
Voltage	Multivolt 10-36V
LED Qty	3 x 1 watt GEN III
Flash Rate	45 flashes per min
Cable	34cm cable
Draw	Peak
@13.8V	0.13A
@28V	0.13A



Part Number
112ABM - Multivolt 10-110V, Blister single

Function	Strobe beacon
Size	130mm x 98mm
Voltage	Multivolt 10-110V
LED Qty	3 x 1 watt GEN III
Flash Rate	45 flashes per min
Cable	34cm cable
Draw	Peak
@13.8V	0.13A
@28V	0.13A

Fitting instructions

111 Series - Fit to flat surface with foam gasket fitted between lamp and fixing surface using bolt in centre of lamp.

112 Series - Fit to flat surface with foam gasket fitted between lamp and fixing surface using screws at two fixing points supplied.

Technical drawings

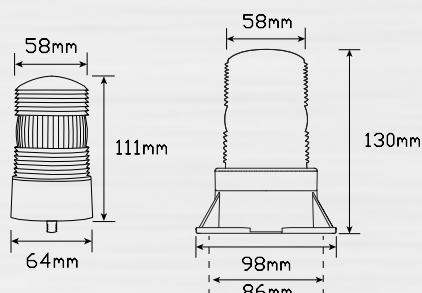

Blister Packaging



Hazard Warning Strobe Beacons

- High brightness LED
- Shock, dust & water proof
- 5 Year warranty



Part Number

127AMM - Multivolt 12-24V, Bulk Boxed

Function	Magnetic strobe beacon
Size	127mm round x 97mm
Voltage	Multivolt 12-24V
LED Qty	1 x GNEII Super LED
Flash Rate	60-70 triple flashes per min
Cable	12 foot/3.6mt retractable cord ending in power source plug

Draw	Peak
@13.8V	0.19A
@28V	0.12A



Part Number

127WMM - Multivolt 12-24V, Clear lens white LEDs, Box Boxed

Function	Magnetic strobe beacon
Size	127mm round x 97mm
Voltage	Multivolt 12-24V
LED Qty	1 x GNEII Super LED
Flash Rate	60-70 triple flashes per min
Cable	12 foot/3.6mt retractable cord ending in power source plug

Draw	Peak
@13.8V	0.19A
@28V	0.12A

Fitting instructions

Place onto flat metal surface and run retractable cord to power source within vehicle.

Not for highway use.

Technical drawings

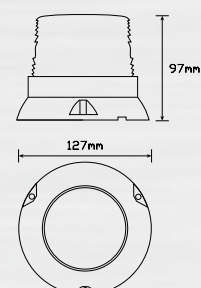

Hazard Warning Strobe Beacons

- High brightness LED
- Shock, dust & water proof
- 5 Year warranty



Part Number
127AMF - Multivolt 12-24V, Bulk Boxed

Function	Fixed mount strobe beacons
Size	127mm round x 97mm
Voltage	Multivolt 12-24V
LED Qty	1 x GNEII Super LED
Flash Rate	60-70 triple flashes per min
Cable	40cm cable
Draw	Peak
@13.8V	0.19A
@28V	0.12A



Part Number
182AM - Multivolt 11-36V, Bulk Boxed

Function	Fixed mount strobe beacons
Size	182mm round x 125mm
Voltage	Multivolt 11-36V
LED Qty	6 x GENII high powered
Flash Rate	120 - 240 flashes per min
Cable	34cm cable
Draw	Peak
@13.8V	0.26A
@28V	0.46A

Fitting instructions

127 Series - Run wires through hole in fixing surface or from the side of the base. Attach with screws provided, ensure foam gasket is between lamp and fitting surface.

182 Series - Run wires through hole in fixing surface or from the side of the base. Attach with bolts provided, ensure foam gasket is between lamp and fitting surface.

Technical drawings

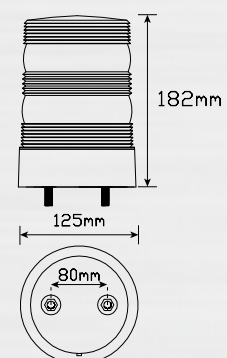

Rotating Beacons

- Rotating pattern
- Shock, dust & water proof
- 3 Year warranty



Rotating pattern beacons

LED Technologies presents its new range of rotating pattern LED beacons. Using state of the art electronic components with no mechanical or moving parts to achieve the Rotating beacon simulation. These lamps offer low current draw, low maintenance and long operational life. Manufactured using tough polycarbonate lens and base, fully sealed dust and water proof. Backed by a three year warranty. ECE/R10, SAEJ845 Class2 or class3 approvals. See it on our youtube channel.



Part Number
LRB130 - Multivolt 10-30V, Blister single

Function	Rotating effect small amber beacon
Size	130mm round x 53mm
Voltage	Multivolt 10-30V
LED Qty	20
Flash Rate	N/A
Cable	40cm cable
Draw	Peak
@13.8V	0.11A
@28V	0.07A
Approvals	Function Category
SAE	Beacon SAE J845 Class 3

Fitting instructions

Run wires through hole in fixing surface or from the side of the base. Attach with screws provided, ensure foam gasket is between lamp and fixing surface.

Technical drawings

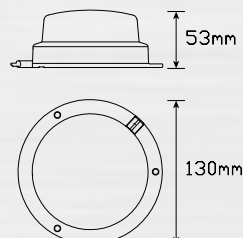

Blister Packaging



Rotating Beacons

- Rotating pattern
- Shock, dust & water proof
- 3 Year warranty



Part Number
LRB145 - Multivolt 10-30V, Blister single

Function	Rotating effect medium amber beacon	
Size	144mm round x 96mm	
Voltage	Multivolt 10-30V	
LED Qty	24	
Flash Rate	N/A	
Cable	40cm cable	
Draw	Peak	
@13.8V	0.45A	
@28V	0.22A	
Approvals	Function	Category
SAE	Beacon	SAE J845 Class 2



Part Number
LRB190 - Multivolt 10-30V, Bulk boxed

Function	Rotating effect large amber beacon	
Size	190mm round x 130mm	
Voltage	Multivolt 10-30V	
LED Qty	36	
Flash Rate	N/A	
Cable	40cm cable	
Draw	Peak	
@13.8V	0.95A	
@28V	0.48A	
Approvals	Function	Category
ECE	Beacon	R10

Fitting instructions

Run wires through hole in fixing surface or from the side of the base. Attach with screws provided, ensure foam gasket is between lamp and fixing surface.

Technical drawings

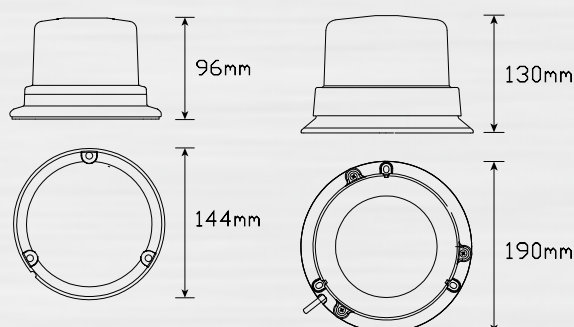

Blister Packaging



Arrow Board and Trafficator Lamps

- Centre brightness 700Cd
- Shock, dust & water proof
- 5 Year warranty



Part Number
83R - 12 Volt, Bulk boxed

Function	Traffic/Arrow board lamp
Size	140mm round x 83mm
Voltage	12 Volt
LED Qty	48 x 30° round
Output	700Cd Centre brightness
Cable	10cm cable
Draw @13.8V	Red 0.42A
Approvals Nil	Function Category Beacon N/A



Part Number
83A - 12 Volt, Bulk boxed

Australian regulatory approved for arrow boards	
Function	Traffic/Arrow board lamp
Size	140mm round x 83mm
Voltage	12 Volt
LED Qty	48 x 30° round
Output	700Cd Centre brightness
Cable	10cm cable
Draw @13.8V	Amber 0.42A
Approvals Australian Standards	Function Category Beacon AS 41952-2006

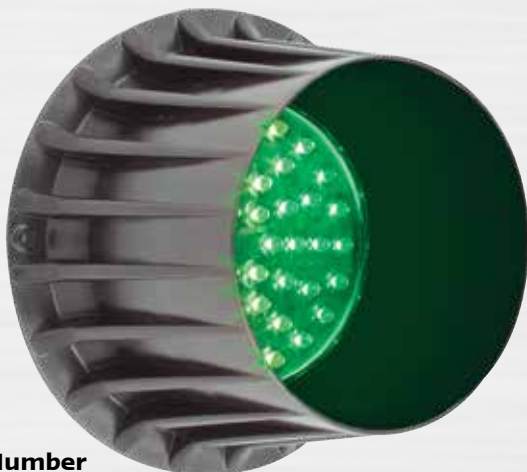

Part Number
83G - 12 Volt, Bulk boxed

Function	Traffic/Arrow board lamp
Size	140mm round x 83mm
Voltage	12 Volt
LED Qty	48 x 30° round
Output	700Cd Centre brightness
Cable	10cm cable
Draw @13.8V	Green 0.66A
Approvals Nil	Function Category Beacon N/A

Fitting instructions

Fit to flat surface with three screws supplied ensuring 4 inch "O" ring is positioned under base. Run wires from back of lamp.

Technical drawings

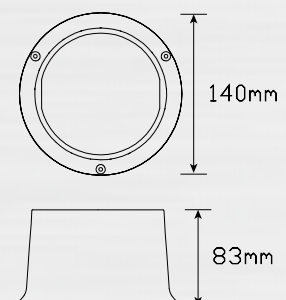

Arrow Board and Trafficator Lamps

- Special design lamps
- Shock, dust & water proof
- 5 Year warranty



Part Number
5526A - 12 Volt, Bulk poly bag

Function	Arrow board lamp	
Size	109mm round x 10mm	
Voltage	12 Volt	
LED Qty	48	
Output	500Cd Centre brightness	
Plug	use part no. 55062	
Draw	Low intensity	High intensity
@13.8V	0.04A	0.43A



Part Number
5525GM - Multivolt 12-24V, Blister single

Function	Mining forward direction indicator, Green emergency.
Size	109mm round x 10mm
Voltage	Multivolt 12-24V
LED Qty	16
Output	500Cd Centre brightness
Plug	use part no. 55062
Draw	Green
@13.8V	0.11A

Fitting Instructions

Retro fit to existing 4 inch lamps. If new installation fit grommet or flange into cutout (Cut out 115mm round) plug wire into lamp and run through back then push into grommet/flange. Please refer to ADR 13/00 for mounting instructions.

Accessories



Black Bracket



Chrome Bracket



Grommet



55062 - Plug

Technical Drawings

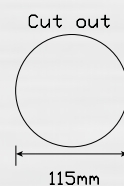
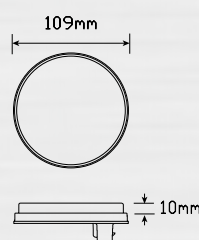

Blister Packaging



Work/Spot Lamps

- Compact size work/spot lamp
- Shock, dust & water proof
- 2 Year warranty



Function	10 Watt Spot or flood Lamp
Size	66mm x 66mm x 65mm
Voltage	Multivolt 10-30V
LED Qty	1 x 10 Watt
Cable	40cm cable
Draw	
@13.8V	0.9A
@28V	0.4A

Part Number

6610SBM - Multivolt 10-30V, Spot beam, Blister single
6610FBM - Multivolt 10-30V, Flood beam, Blister single



Function	12 Watt Spot Lamp
Size	66mm x 66mm x 65mm
Voltage	Multivolt 10-30V
LED Qty	4 x 3 Watt
Cable	40cm cable
Draw	
@13.8V	0.9A
@28V	0.40A

Part Number

6612BM - Multivolt 10-30V, Blister single

Fitting Instructions

Fix to mounting surface using stainless steel bolts and adjustable stainless steel bracket supplied.

Technical Drawings

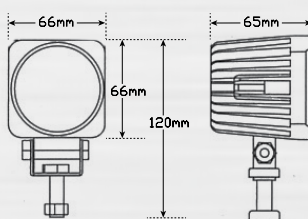

Blister Packaging



Work/Spot Lamps

- Original design by LED Autolamps
- Shock, dust & water proof
- 5 Year warranty



Part Number
7150BM - Multivolt 12-24V, Blister single

Function	2.5 watt Flood Lamp
Size	114mm x 48mm x 71mm
Voltage	Multivolt 12-24V
LED Qty	5 x 0.5 watt
Cable	30cm cable
Draw	
@13.8V	0.30A
@28V	0.19A



Part Number
7790BM - Multivolt 12-24V, Blister single

Function	9 watt Flood Lamp
Size	169mm x 60mm x 77mm
Voltage	Multivolt 12-24V
LED Qty	9 x 1 watt
Cable	30cm cable
Draw	
@13.8V	0.97A
@28V	0.44A

Fitting Instructions

Fix to mounting surface using stainless steel bolts and adjustable stainless steel bracket supplied.

Technical Drawings

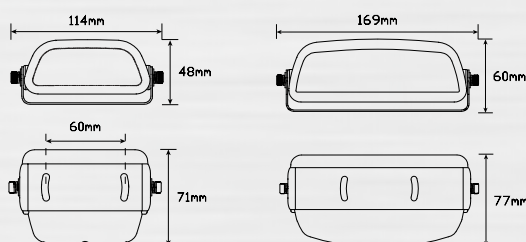

Blister Packaging



Work/Spot Lamps

- High quality premium brand
- Shock, dust & water proof
- 5 Year warranty



Part Number

- 896SBM** - Multivolt 10-30V, Spot beam, Bulk boxed
896FBM - Multivolt 10-30V, Flood beam, Bulk boxed

Function	18 Watt Spot or flood Lamp
Size	89mm round x 58mm
Voltage	Multivolt 10-30V
LED Qty	6 x 3 watt
Cable	40cm cable
Draw	
@13.8V	1.46A
@28V	0.7A



Part Number

- 14224FBM** - Multivolt 9-32V, Blister single

Function	24 watt Flood Lamp
Size	142mm x 122mm x 45mm
Voltage	Multivolt 9-32V
LED Qty	8 x 3 watt
Cable	25cm cable
Draw	
@13.8V	1.10A
@28V	0.66A

Fitting Instructions

Fix to mounting surface using stainless steel bolts and adjustable stainless steel bracket supplied.

Technical Drawings

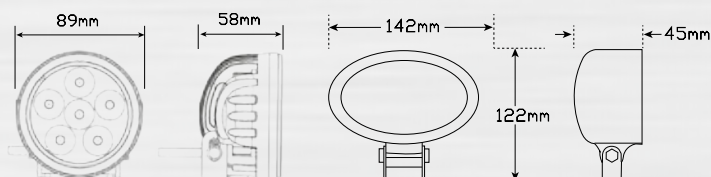

Blister Packaging



Work/Spot Lamps

- High quality premium brand
- Shock, dust & water proof
- 5 Year warranty



Function	12 watt Flood Lamp
Size	84mm round x 65mm
Voltage	Multivolt 10-30V
LED Qty	4 x 3 watt
Cable	25cm cable
Draw	
@13.8V	0.68A
@28V	0.36A

Part Number

8312BM - Multivolt 10-30V, Blister single



Function	20 watt spot Lamp
Size	81mm x 80mm x 105mm
Voltage	Multivolt 10-30V
LED Qty	4 x 5 watt
Cable	40cm cable
Draw	
@13.8V	1.33A
@28V	0.66A

Part Number

814SBM - Multivolt 10-30V, Bulk boxed

Fitting Instructions

Fix to mounting surface using stainless steel bolts and adjustable stainless steel bracket supplied.

Technical Drawings

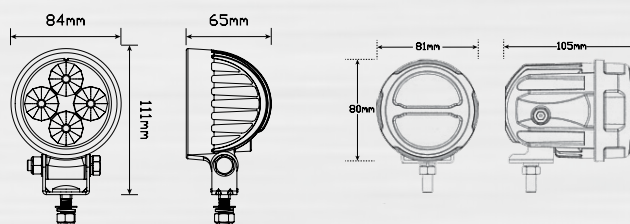

Blister Packaging



Work/Spot Lamps

- Budget brand
- Shock, dust & water proof
- 2 Year warranty



Function	18 watt Flood Lamp
Size	115mm x 137mm x 40mm
Voltage	Multivolt 9-32V
LED Qty	6 x 3 watt
Cable	25cm cable
Draw	
@13.8V	0.78A
@28V	0.48A

Part Number

11618FBM - Multivolt 9-32V, Blister single



Function	15 Watt Flood Lamp
Size	110mm x 137mm x 45mm
Voltage	Multivolt 9-32V
LED Qty	5 x 3 watt
Cable	25cm cable
Draw	
@13.8V	0.87A
@28V	0.52A

Part Number

11518FBM - Multivolt 9-32V, Blister single

Fitting Instructions

Fix to mounting surface using stainless steel bolts and adjustable stainless steel bracket supplied.

Technical Drawings

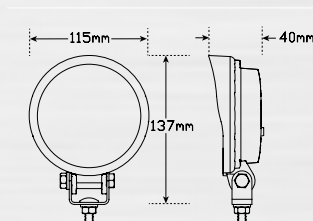

Technical Drawings

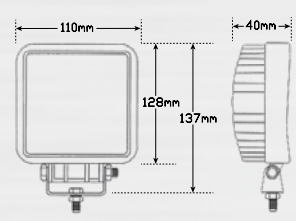

Work/Spot Lamps

- High quality premium brand
- Shock, dust & water proof
- 5 Year warranty



Part Number

7450B12 - 12 Volt, Blister single

7450B24 - 24 Volt, Blister single

Function	6 watt Flood Lamp
Size	129mm x 158mm x 90mm
Voltage	12 Volt or 24 Volt
LED Qty	6 x 1 watt
Cable	30cm cable
Draw	
@13.8V	1.29A
@28V	0.30A



Part Number

7451BM - Multivolt 12-24V, Blister single

Function	6 watt Flood Lamp
Size	149mm x 115mm x 41mm
Voltage	Multivolt 12-24V
LED Qty	6 x 1 watt
Cable	30cm cable
Draw	
@13.8V	0.75A
@28V	0.38A

Fitting Instructions

Fix to mounting surface using stainless steel bolts and adjustable stainless steel bracket supplied.

Technical Drawings

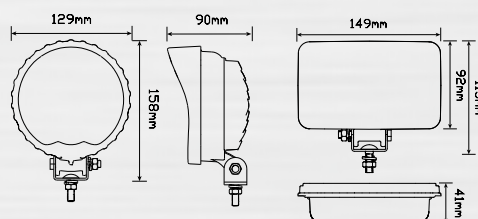

Blister Packaging



Work/Spot Lamps

- High quality premium brand
- Shock, dust & water proof
- 5 Year warranty



Function	18 watt Spot Lamp
Size	160mm x 45mm x 63mm
Voltage	Multivolt 10-30V
LED Qty	6 x 3 watt
Cable	40cm cable
Draw	
@13.8V	1.42A
@28V	0.7A

Part Number

16018BM - Multivolt 10-30V, Blister single



Function	18 watt recessed flood lamp
Size	122mm x 92mm x 80mm
Voltage	Multivolt 10-30V
LED Qty	6 x 3 watt
Cable	40cm cable
Draw	
@13.8V	1.3A
@28V	0.67A

Part Number

1226FBM - Multivolt 10-30V, Bulk boxed

Fitting Instructions

16018BM - Fix to mounting surface using stainless steel bolts and adjustable stainless steel bracket supplied.

1226FBM - Recessed mount
Cut out 84mm x 77mm

Technical Drawings

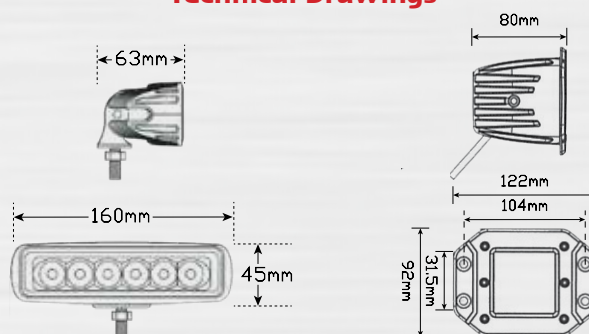

Blister Packaging



Work/Spot Lamps

- High brightness premium brand
- Shock, dust & water proof
- 5 Year warranty



Function	40 Watt Spot or flood Lamp
Size	110mm x 120mm x 92mm
Voltage	Multivolt 12-24V
LED Qty	4 x 10 watt
Cable	24cm cable
Draw	
@13.8V	1.86A
@28V	1.07A

Part Number

10940SBM - Multivolt 12-24V, Spot beam, Bulk boxed

10940FBM - Multivolt 12-24V, Flood beam, Bulk boxed



Function	30 Watt Flood Lamp
Size	126mm x 126mm x 85mm
Voltage	Multivolt 10-30V
LED Qty	1 x 30 watt
Cable	94cm cable
Draw	
@13.8V	2.7A
@28V	1.3A

Part Number

12630FBM - Multivolt 10-30V, Bulk boxed

Fitting Instructions

Fix to mounting surface using stainless steel bolts and adjustable stainless steel bracket supplied.

Technical Drawings

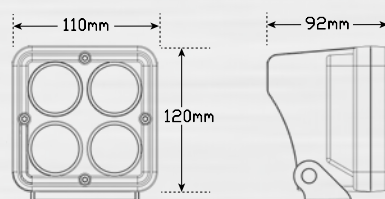

Technical Drawings

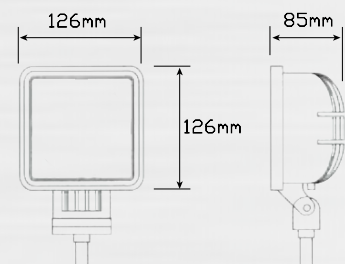

Work/Spot Lamps

- Available in spot or flood
- Shock, dust & water proof
- 2 Year warranty



Function	90 Watt Spot or flood Lamp
Size	135mm x 160mm x 124mm
Voltage	Multivolt 10-30V
LED Qty	9 x 10 watt
Cable	40cm cable
Draw	
@13.8V	6.4A
@28V	3.1A

Part Number

- 13590SBM** - Multivolt 10-30V, Spot beam, Bulk boxed
13590FBM - Multivolt 10-30V, Flood beam, Bulk boxed



Driving Light

Function	60 Watt Driving/Spot Lamp
Size	229mm round x 93mm
Voltage	Multivolt 10-30V
LED Qty	6 x 10w (48 SMD outer ring)
Cable	57cm
Draw	
@13.8V	3.67A
@28V	1.83A

Part Number

- 2296SBM** - Multivolt 10-30V, Bulk boxed

Fitting Instructions

Fix to mounting surface using stainless steel bolts and adjustable stainless steel bracket supplied.

Technical Drawings

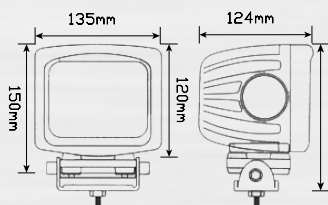

Technical Drawings

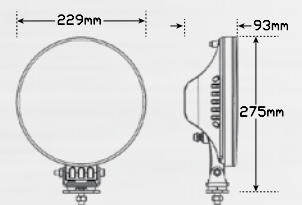

Light Bars

- Budget quality light bars
- Shock, dust & water proof
- 2 Year warranty



Function	20 watt Flood Lamp
Size	225mm x 82mm x 105mm
Voltage	Multivolt 9-32V
LED Qty	2 x 10 watt
Cable	20cm cable
Draw	
@13.8V	0.90A
@28V	0.40A

Part Number

22520FBM - Multivolt 9-32V, Bulk boxed



Function	20 watt Spot Lamp
Size	225mm x 82mm x 105mm
Voltage	Multivolt 9-32V
LED Qty	2 x 10 watt
Cable	20cm cable
Draw	
@13.8V	0.90A
@28V	0.40A

Part Number

22520SBM - Multivolt 9-32V, Bulk boxed

Fitting Instructions

Fix to mounting surface using stainless steel bolts and adjustable stainless steel bracket supplied.

Technical Drawings

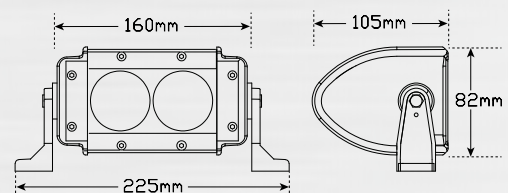

Light Bars

- Budget quality light bars
- Shock, dust & water proof
- 2 Year warranty



Function	40 watt Flood Lamp
Size	320mm x 82mm x 105mm
Voltage	Multivolt 9-32V
LED Qty	4 x 10 watt
Cable	20cm cable
Draw	
@13.8V	1.60A
@28V	0.80A

Part Number

32540FBM - Multivolt 9-32V, Bulk boxed



Function	40 watt Spot Lamp
Size	320mm x 82mm x 105mm
Voltage	Multivolt 9-32V
LED Qty	4 x 10 watt
Cable	20cm cable
Draw	
@13.8V	1.60A
@28V	0.80A

Part Number

32540SBM - Multivolt 9-32V, Bulk boxed

Fitting Instructions

Fix to mounting surface using stainless steel bolts and adjustable stainless steel bracket supplied.

Technical Drawings

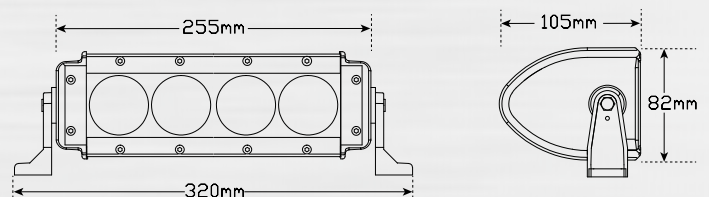

Light Bars

- Premium Brand High Quality
- Shock, dust & water proof
- 5 Year warranty



Part Number
856BM - Multivolt 12-24V, Bulk boxed

Function	6 Watt Flood Lamp
Size	170mm x 110mm x 86mm
Voltage	Multivolt 12-24V
LED Qty	6 x 1 Watt
Cable	1 metre cable
Draw	
@13.8V	0.77A
@28V	0.36A



Part Number
858BM - Multivolt 12-24V, Bulk boxed

Function	8 Watt Flood Lamp
Size	208mm x 110mm x 86mm
Voltage	Multivolt 12-24V
LED Qty	8 x 1 Watt
Cable	1 metre cable
Draw	
@13.8V	1.00A
@28V	0.48A



Part Number
8514BM - Multivolt 12-24V, Bulk boxed

Function	14 Watt Flood Lamp
Size	321mm x 110mm x 86mm
Voltage	Multivolt 12-24V
LED Qty	14 x 1 Watt
Cable	1 metre cable
Draw	
@13.8V	1.80A
@28V	0.78A

Fitting Instructions

Fix to mounting surface using stainless steel bolts and adjustable stainless steel bracket supplied.

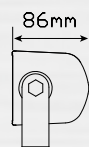

Technical Drawings

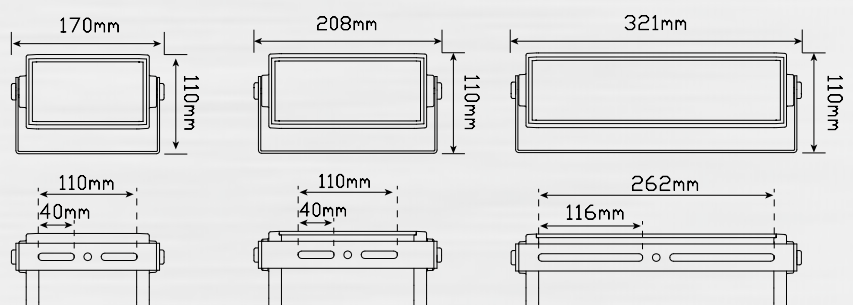

Light Bars

- Budget brand LED light bars
- Shock, dust & water proof
- 2 Year warranty



Part Number
520120BM - Multivolt 10-60V, Bulk boxed

Function 120 Watt Spot Lamp
Size 520mm x 73mm x 90mm
Voltage Multivolt 10-60V
LED Qty 12 x 10 watt
Cable 20cm cable
Draw
 @13.8V 6.70A
 @28V 3.4A



Part Number
760180BM - Multivolt 10-60V, Bulk boxed

Function 180 Watt Spot Lamp
Size 760mm x 73mm x 90mm
Voltage Multivolt 10-60V
LED Qty 18 x 10 watt
Cable 20cm cable
Draw
 @13.8V 10.30A
 @28V 5.10A

Fitting Instructions

Fix to mounting surface using stainless steel bolts and adjustable stainless steel bracket supplied.

Technical Drawings

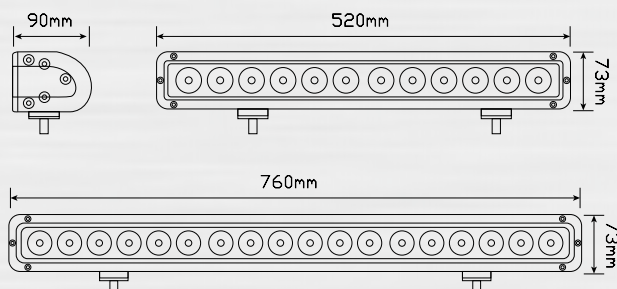

Light Bars

- Premium brand LED light bars
- Shock, dust & water proof
- 5 Year warranty



Part number	Overall dimension	LED number	Watts	Effective Lumens	Raw Lumens	Lux@10m	Beam Distance(m)	Peak Beam Intensity(cd)
598101BM	23.5"	36	108W	5940	7200	2328	965	232800
1300252BM	52"	84	252W	13860	16800	5432	1474	543200



This premium quality light bar consist of the following items
3.7m of cable including water proof plugs, fuse and fuse box, 30 Amp relay and on/off switch.



Part Number
598101BM - Multivolt 12-24V, Bulk boxed

Function 108 Watt Spot Lamp
Size 600mm x 90mm x 110mm
Voltage Multivolt 12-24V
LED Qty 36 x 3 watt
Cable 3.7 metre cable

Draw
@13.8V 7.0A
@28V 3.0A

Illuminance 13860lm



Part Number
1300252BM - Multivolt 12-24V, Bulk boxed

Function 252 Watt Spot Lamp
Size 1318mm x 90mm x 110mm
Voltage Multivolt 12-24V
LED Qty 84 x 3 watt
Cable 3.7 metre cable

Draw
@13.8V 16.0A
@28V 7.2A

Illuminance 5940lm

Fitting Instructions

Fix to mounting surface using stainless steel bolts and adjustable stainless steel bracket supplied.

Technical Drawings

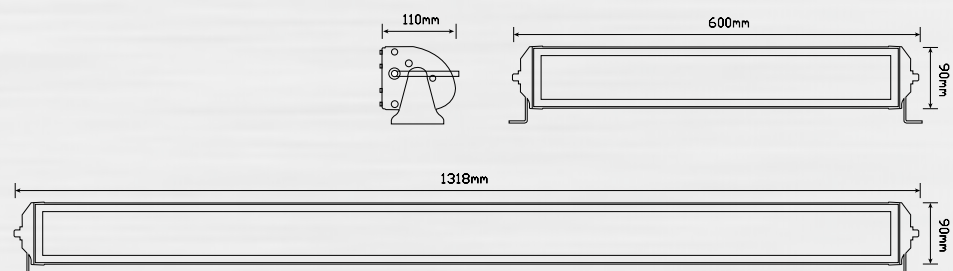

Light Bars

- All black body and lens housing
- Shock, dust & water proof
- 2 Year warranty



Part Number
2896BM - Multivolt 10-30V, Bulk boxed

Function	60 Watt Spot Lamp
Size	289mm x 96mm x 90mm
Voltage	Multivolt 10-30V
LED Qty	6 x 10 watt
Cable	3 metre cable
Draw	
@13.8V	3.5A
@28V	1.6A



Part Number
54312BM - Multivolt 10-30V, Bulk boxed

Function	120 Watt Spot Lamp
Size	543mm x 96mm x 90mm
Voltage	Multivolt 10-30V
LED Qty	12 x 10 watt
Cable	3 metre cable
Draw	
@13.8V	7.8A
@28V	3.1A



Part Number
79718BM - Multivolt 10-30V, Bulk boxed

Function	180 Watt Spot Lamp
Size	797mm x 96mm x 90mm
Voltage	Multivolt 10-30V
LED Qty	18 x 10 watt
Cable	3 metre cable
Draw	
@13.8V	9.8A
@28V	4.9A



Part Number
105124BM - Multivolt 10-30V, Bulk boxed

Function	240 Watt Spot Lamp
Size	1051mm x 96mm x 90mm
Voltage	Multivolt 10-30V
LED Qty	24 x 10 watt
Cable	3 metre cable
Draw	
@13.8V	13.4A
@28V	6.7A

Fitting Instructions

Fix to mounting surface using stainless steel bolts and adjustable stainless steel bracket supplied.

These light bars consist of the following items; 3.0m of cable including water proof plugs, fuse and fuse box, 40 Amp relay and on/off switch.



Technical Drawings

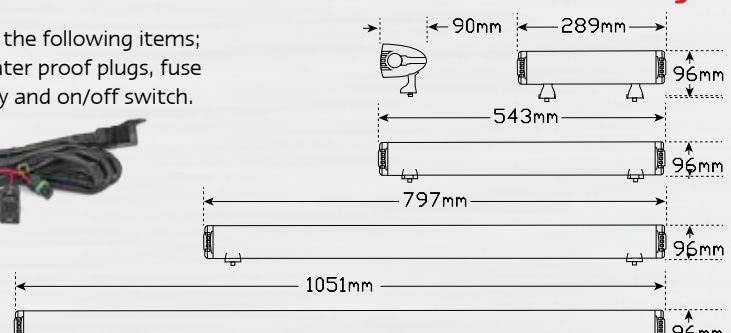

Work Lamps

- Oil resistant non slip rubber housing
- Shock, dust & water proof
- 5 Year warranty



Part Number
HH1061/12 - 12 Volt, Blister single

Function Inspection Lamp
Size 424mm x 31mm
Voltage 12 Volt
LED Qty 61
Cable 3 metre cable with alligator clips

Draw @13.8V 0.31A



Part Number
HH1061/240 - 240 Volt, Blister single

Function Inspection Lamp
Size 424mm x 31mm
Voltage 240 Volt
LED Qty 61
Cable 7 metre cable with transformer

Draw @13.8V 0.31A

Fitting Instructions

N/A

Technical Drawings



Blister Packaging



Marine Lamps

- Navigational lamps
- Sea/salt spray resistant
- 5 Year warranty



Manufactured to comply with international maritime organisation codes and uniform shipping laws



Part Number

52WR - Multivolt 12-24V, Blister single

52CR - Multivolt 12-24V, Blister single

Function Portside lamp
112.5° beam angle

Size 76mm x 52mm x 25mm

Voltage Multivolt 12-24V

LED Qty 10

Cable 18cm cable

Draw **Portside**
@13.8V 0.08A
@28V 0.18A

Approvals ATAC Compliant



Part Number

52WG - Multivolt 12-24V, Blister single

52CG - Multivolt 12-24V, Blister single

Function Starboard lamp
112.5° beam angle

Size 76mm x 52mm x 25mm

Voltage Multivolt 12-24V

LED Qty 10

Cable 18cm cable

Draw **Starboard**
@13.8V 0.12A
@28V 0.20A

Approvals ATAC Compliant



Part Number

52WW - Multivolt 12-24V, Blister single

52CW - Multivolt 12-24V, Blister single

Function Stern/towing lamp
135° beam angle

Size 76mm x 52mm x 24mm

Voltage Multivolt 12-24V

LED Qty 10

Cable 18cm cable

Draw **Stem/towing**
@13.8V 0.18A
@28V 0.10A

Approvals ATAC Compliant

Fitting Instructions

Remove back plate with small screw driver and fix at two screw points with screws supplied, clip lamp and housing in place.

Technical Drawings

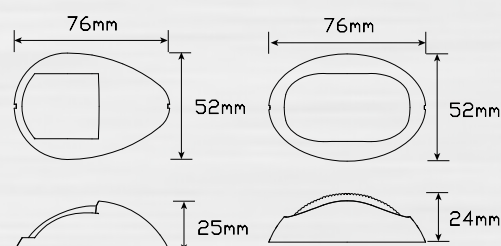

Blister Packaging



Marine Lamps

- Dual function Red/White lamp
- 3 Way function switch
- 3 Year warranty

INTERIOR ONLY

12V only
VOLTAGE SPECIFIC



Part Number

143RWW - 12 Volt, Blister single



Part Number

143RWB - 12 Volt, Blister single

Marine Interior Lamps Dual colour marine lamp red and white. Red light night vision, no glare and non sensitive at night. Multi purpose applications in all areas where night vision is required when sensitivity to the eyes is important. With the coloured ambient light our night vision lamps are easy on the eye when coming from darkness. On/Off Switch for separate colours. Interior use only.

Function	Marine Interior Lamps	
Size	143mm Round x 40mm	
Voltage	12 Volt	
LED Qty	120	
Cable	40cm cable	
Draw @13.8V	White	Red
	0.33A	0.33A

Fitting Instructions

Remove bezel and surface mount using three screw points, run wires through hole in mounting surface and refit bezel by clicking into place.

Technical Drawings

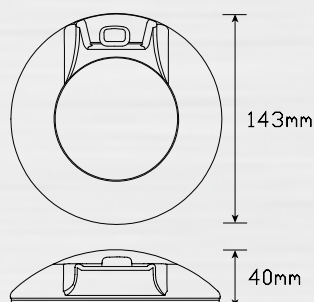

Blister Packaging



Marine Submersible Lamps

- 180° Light spread
- Sea salt spray tested
- 3 Year warranty



Part Number
91RM - Multivolt 12-24V, Bulk boxed



Part Number
91BM - Multivolt 12-24V, Bulk boxed



Part Number
91GM - Multivolt 12-24V, Bulk boxed



Part Number
91WM - Multivolt 12-24V, Bulk boxed



Side view of lamp

Function Coloured marine lamps
Size 112mm x 37mm x 23mm
Voltage Multivolt 12-24V
LED Qty 3 x 1 Watt
Flash Rate Constant
Cable 18cm cable

Draw	Lamp	Constant
@13.8V	91CRM	0.15A
@28V	91CRM	0.06A
@13.8V	91CBM	0.16A
@28V	91CBM	0.12A
@13.8V	91CGM	0.16A
@28V	91CGM	0.12A
@13.8V	91CWM	0.20A
@28V	91CWM	0.19A

Function Coloured marine lamps
Size 112mm x 37mm x 23mm
Voltage Multivolt 12-24V
LED Qty 3 x 1 Watt
Flash Rate Constant
Cable 18cm cable

Draw	Lamp	Constant
@13.8V	91CRM	0.15A
@28V	91CRM	0.06A
@13.8V	91CBM	0.16A
@28V	91CBM	0.12A
@13.8V	91CGM	0.16A
@28V	91CGM	0.12A
@13.8V	91CWM	0.20A
@28V	91CWM	0.19A

Fitting instructions

Fix to flat surface at two fixing points.

Technical drawings

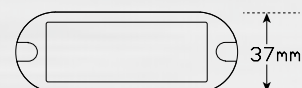
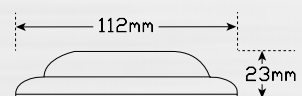

Marine Work/Spot Lamps

- Original design by LED Autolamps
- Shock, dust & water proof
- 5 Year warranty



Function	2.5 watt Flood Lamp
Size	114mm x 48mm x 71mm
Voltage	Multivolt 12-24V
LED Qty	5 x 0.5 watt
Cable	30cm cable
Draw	
@13.8V	0.30A
@28V	0.19A

Part Number

7150WM - Multivolt 12-24V, White housing, Blister single



Function	9 watt Flood Lamp
Size	169mm x 60mm x 77mm
Voltage	Multivolt 12-24V
LED Qty	9 x 1 watt
Cable	30cm cable
Draw	
@13.8V	0.97A
@28V	0.44A

Part Number

7790WM - Multivolt 12-24V, White housing, Blister single

Fitting Instructions

Fix to mounting surface using stainless steel bolts and adjustable stainless steel bracket supplied.

Technical Drawings

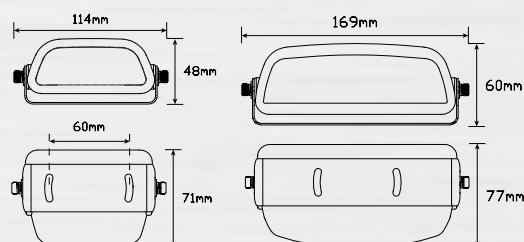

Blister Packaging



Marine Work/Spot Lamps

- Compact size work/spot lamp
- Shock, dust & water proof
- 2 Year warranty



Part Number

6612WM - Multivolt 10-30V, White housing, Blister single

Function	12 Watt Spot Lamp
Size	66mm x 66mm x 65mm
Voltage	Multivolt 10-30V
LED Qty	4 x 3 watt
Cable	40cm cable
Draw	
@13.8V	0.9A
@28V	0.04A



Part Number

16018WM - Multivolt 10-30V, White housing, Blister single

Function	18 watt Spot Lamp
Size	160mm x 45mm x 63mm
Voltage	Multivolt 10-30V
LED Qty	6 x 3 watt
Cable	40cm cable
Draw	
@13.8V	1.42A
@28V	0.73A

Fitting Instructions

Fix to mounting surface using stainless steel bolts and adjustable stainless steel bracket supplied.

Technical Drawings

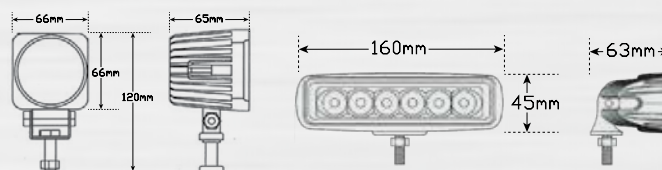

Blister Packaging



Marine Work/Spot Lamps

- High quality premium brand
- Shock, dust & water proof
- 5 Year warranty



Function	12 watt Flood Lamp
Size	84mm round x 65mm
Voltage	Multivolt 10-30V
LED Qty	4 x 3 watt
Cable	25cm cable
Draw	
@13.8V	0.68A
@28V	0.36A

Part Number

8312WM - Multivolt 10-30V, White housing, Blister single



Function	6 watt Flood Lamp
Size	129mm x 158mm x 90mm
Voltage	12 Volt or 24 Volt
LED Qty	6 x 1 watt
Cable	30cm cable
Draw	
@13.8V	1.29A
@28V	0.30A

Part Number

7450W12 - 12 Volt, White housing, Blister single

7450W24 - 24 Volt, White housing, Blister single

Fitting Instructions

Fix to mounting surface using stainless steel bolts and adjustable stainless steel bracket supplied.

Technical Drawings

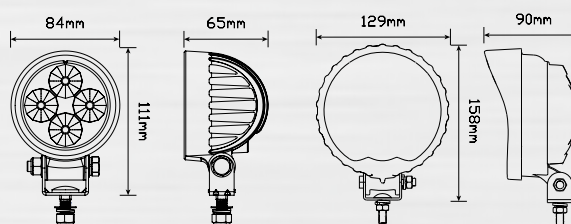

Blister Packaging



Marine Work/Spot Lamps

- High quality premium brand
- Shock, dust & water proof
- 5 Year warranty



Function	24 watt Flood Lamp
Size	142mm x 122mm x 45mm
Voltage	Multivolt 9-32V
LED Qty	8 x 3 watt
Cable	25cm cable
Draw	
@13.8V	1.10A
@28V	0.66A

Part Number
14224FWM - Multivolt 9-32, Blister single



Function	6 watt Flood Lamp
Size	149mm x 115mm x 41mm
Voltage	Multivolt 12-24V
LED Qty	6 x 1 watt
Cable	30cm cable
Draw	
@13.8V	0.75A
@28V	0.38A

Part Number
7451WM - Multivolt 12-24V, Blister single

Fitting Instructions

Fix to mounting surface using stainless steel bolts and adjustable stainless steel bracket supplied.

Technical Drawings

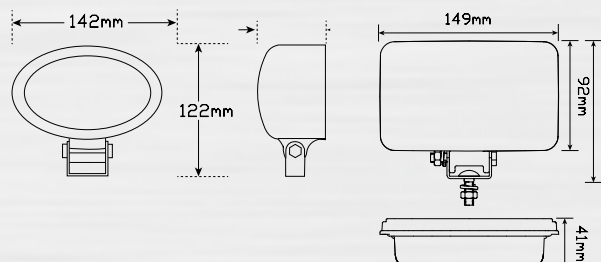

Blister Packaging



Marine Search/Spot Lamps

- Beam distance 959M
- 360° unlimited rotation with 120° tilt
- Hand held remote control



Function	24 watt Search/ Spot Light
Size	182mm x 169mm x 149mm
Voltage	12 Volt
LED Qty	8 x 3 watt CREE
Cable	25cm Cable
Draw	
@13.8V	2.20A
@28V	1.20A

Part Number

1828SLBM - 12 Volt, Bulk boxed



Function	24 watt Search/ Spot Light
Size	182mm x 169mm x 149mm
Voltage	12 Volt
LED Qty	8 x 3 watt CREE
Cable	25cm Cable
Draw	
@13.8V	2.20A
@28V	1.20A

Part Number

1828SLWM - 12 Volt, Bulk boxed

Fitting Instructions

Fix to mounting surface using stainless steel bolts ensure rubber spacer is fitted.

Remote control operation distance of 65 meters.



See this lamp on our you-tube channel

Technical Drawings

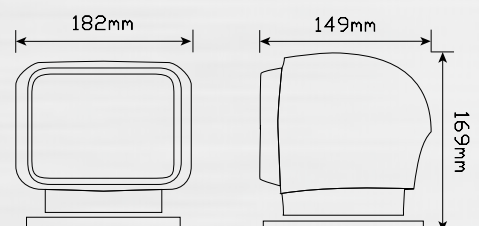

Interior Lamps

- High brightness 70° spread
- Low profile
- 3 Year warranty



Part Number
7524W - 12 Volt, Blister single
7530W - 24 Volt, Blister single

Function Courtesy lamp clear lens/
White bezel
Size 75mm Round x 17mm
Voltage 12 Volt or 24 Volt
LED Qty 12V = 24, 24V = 30
Cable 40cm cable
Draw
@13.8V 0.24A
@28V 0.13A

Colour temperature scale

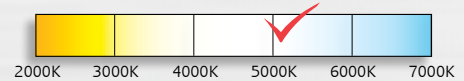

Part Number
7524C - 12 Volt, Blister single
7530C - 24 Volt, Blister single

Function Courtesy lamp clear lens/
Chrome bezel
Size 75mm Round x 17mm
Voltage 12 Volt or 24 Volt
LED Qty 12V = 24, 24V = 30
Cable 40cm cable
Draw
@13.8V 0.24A
@28V 0.13A

Colour temperature scale



Part Number
7524/OPAQUE - 12 Volt, Blister single
7530/OPAQUE - 24 Volt, Blister single

Function Courtesy lamp opaque lens/
Chrome bezel
Size 75mm Round x 17mm
Voltage 12 Volt or 24 Volt
LED Qty 12V = 24, 24V = 30
Cable 40cm cable or plugs
Draw
@13.8V 0.12A
@28V 0.04A

Colour temperature scale

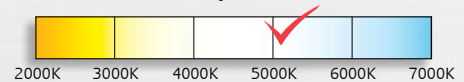

Fitting instructions

Remove bezel and surface mount using three screw points, run wires through hole in mounting surface and refit bezel by clicking into place.

Accessories

75C - Chrome Bezel
 75G - Gold Bezel
 75W - White Bezel

Technical Drawings

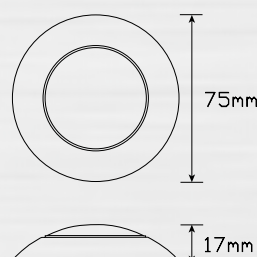

Blister Packaging



Interior Lamps

- Illuminated on/off switch
- Shock, dust & water proof
- 3 Year warranty



Part Number
79BWR12 - 12 Volt, Blister single

Function Interior only courtesy lamp with black bezel
Size 80mm Round x 14mm
Voltage 12 Volt
LED Qty 12
Cable 20cm cable
Draw @13.8V **Off** 0.01A **On** 0.09A

Colour temperature scale

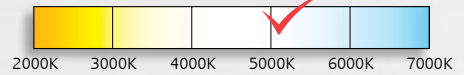

Part Number
79WWR12 - 12 Volt, Blister single

Function Interior only courtesy lamp with white bezel
Size 80mm Round x 14mm
Voltage 12 Volt
LED Qty 12
Cable 20cm cable
Draw @13.8V **Off** 0.01A **On** 0.09A

Colour temperature scale

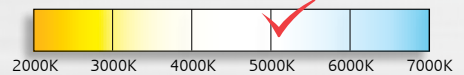

Part Number
79CWR12 - 12 Volt, Blister single

Function Interior only courtesy lamp with chrome bezel
Size 80mm Round x 14mm
Voltage 12 Volt
LED Qty 12
Cable 20cm cable
Draw @13.8V **Off** 0.01A **On** 0.09A

Colour temperature scale

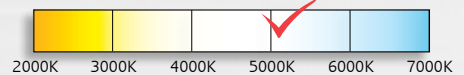

Part Number
79GWR12 - 12 Volt, Blister single

Function Interior only courtesy lamp with gold bezel
Size 80mm Round x 14mm
Voltage 12 Volt
LED Qty 12
Cable 20cm cable
Draw @13.8V **Off** 0.01A **On** 0.09A

Colour temperature scale

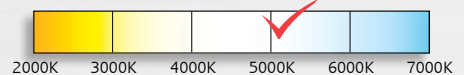

Fitting instructions

Remove base by twisting until it is released from lamp and mount onto flat surface using three screw points. Run wires through hole in mounting surface and refit lamp by turning back into place.

Technical Drawings

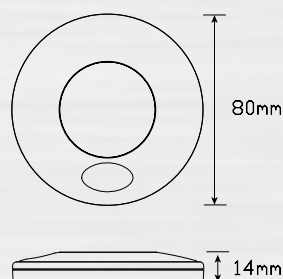

Blister Packaging



Interior Lamps

- Low profile, dome shaped design
- 120° light spread
- 3 Year warranty



Part Number
148BW12 - 12 Volt, Blister single

Function Low profile domed interior lamp
Size 148mm x 71mm x 20mm
Voltage 12 Volt
LED Qty 24
Cable 20cm cable
Draw @13.8V 0.17A

Colour temperature scale

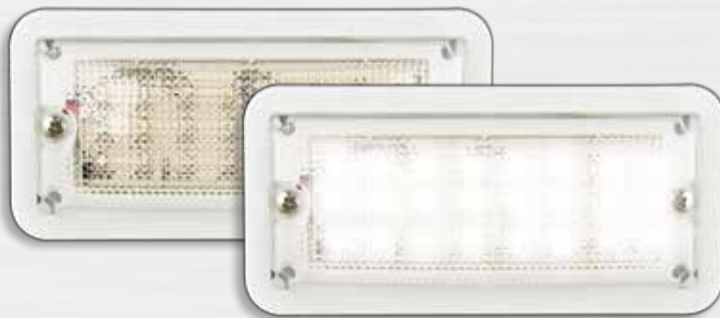
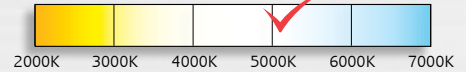

Part Number
148WW12 - 12 Volt, Blister single

Function Low profile domed interior lamp
Size 148mm x 71mm x 20mm
Voltage 12 Volt
LED Qty 24
Cable 20cm cable
Draw @13.8V 0.17A

Colour temperature scale

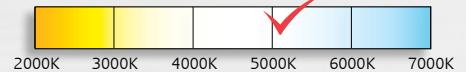

Part Number
148GW12 - 12 Volt, Blister single

Function Low profile domed interior lamp
Size 148mm x 71mm x 20mm
Voltage 12 Volt
LED Qty 24
Cable 20cm cable
Draw @13.8V 0.17A

Colour temperature scale

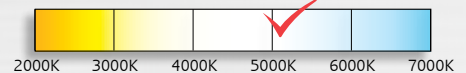

Fitting instructions

Remove lens from base, surface mount with 4 fixing points using screws supplied. Run wires through fixing surface from back of lamp. Refit lens.

Technical Drawings

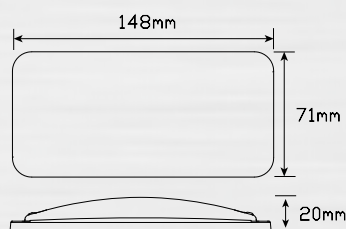

Blister Packaging



Interior Lamps

- Inbuilt On/Off switch
- Low profile design
- 3 Year warranty



Part Number

1061/12SW - 12 Volt, Blister single
1061/24SW - 24 Volt, Blister single

Function Strip lamp
Size 300mm x 25mm x 10mm
Voltage 12 Volt or 24 Volt
LED Qty 61
Cable 10cm cable
Draw
@13.8V 0.31A
@28V 0.17A



Part Number

1061/12SWOPAQUE - 12 Volt, Blister single
1061/24SWOPAQUE - 24 Volt, Blister single

Function Strip lamp
Size 300mm x 25mm x 10mm
Voltage 12 Volt or 24 Volt
LED Qty 61
Cable 10cm cable
Draw
@13.8V 0.31A
@28V 0.17A



Part Number

10121/12SW - 12 Volt, Blister single
10121/24SW - 24 Volt, Blister single

Function Strip lamp
Size 600mm x 25mm x 10mm
Voltage 12 Volt or 24 Volt
LED Qty 121
Cable 10cm cable
Draw
@13.8V 0.58A
@28V 0.31A



Part Number

10121/12SWOPAQUE - 12 Volt, Blister single
10121/24SWOPAQUE - 24 Volt, Blister single

Function Strip lamp
Size 600mm x 25mm x 10mm
Voltage 12 Volt or 24 Volt
LED Qty 121
Cable 10cm cable
Draw
@13.8V 0.58A
@28V 0.31A

Fitting instructions

Remove bezel at each end and surface mount using two screw points, run wires through hole in mounting surface and refit bezel by clicking into place.

Technical Drawings



Blister Packaging



Interior Lamps

- Clear lens 120° spread
- Low profile design
- 3 Year warranty



Part Number
1016 - 12 Volt, Blister single
1016/24 - 24 Volt, Blister single

Function Strip lamp
Size 100mm x 25mm x 10mm
Voltage 12 Volt or 24 Volt
LED Qty 16
Cable 10cm cable
Draw
@13.8V 0.11A
@28V 0.05A



Part Number
1031 - 12 Volt, Blister single
1031/24 - 24 Volt, Blister single

Function Strip lamp
Size 150mm x 25mm x 10mm
Voltage 12 Volt or 24 Volt
LED Qty 31
Cable 10cm cable
Draw
@13.8V 0.17A
@28V 0.07A



Part Number
1061 - 12 Volt, Blister single
1061/24 - 24 Volt, Blister single

Function Strip lamp
Size 300mm x 25mm x 10mm
Voltage 12 Volt or 24 Volt
LED Qty 61
Cable 10cm cable
Draw
@13.8V 0.31A
@28V 0.17A

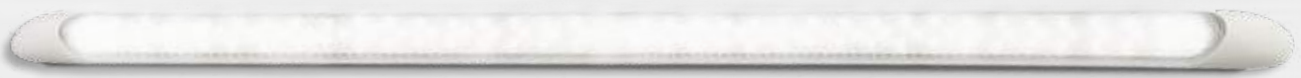

Part Number
10121 - 12 Volt, Blister single
10121/24 - 24 Volt, Blister single

Function Strip lamp
Size 600mm x 25mm x 10mm
Voltage 12 Volt or 24 Volt
LED Qty 121
Cable 10cm cable
Draw
@13.8V 0.58A
@28V 0.31A

Fitting instructions

Remove bezel at each end and surface mount using two screw points, run wires through hole in mounting surface and refit bezel by clicking into place.

Technical Drawings

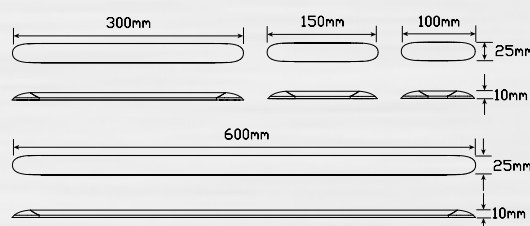

Blister Packaging



Interior Lamps

- Opaque lens 120° spread
- Low profile design
- 3 Year warranty



Part Number
1016/OPAQUE - 12 Volt, Blister single
1016/24OPAQUE - 24 Volt, Blister single

Function Strip lamp
Size 100mm x 25mm x 10mm
Voltage 12 Volt or 24 Volt
LED Qty 16
Cable 10cm cable
Draw @13.8V 0.11A
 @28V 0.05A



Part Number
1031/OPAQUE - 12 Volt, Blister single
1031/24OPAQUE - 24 Volt, Blister single

Function Strip lamp
Size 150mm x 25mm x 10mm
Voltage 12 Volt or 24 Volt
LED Qty 31
Cable 10cm cable
Draw @13.8V 0.17A
 @28V 0.07A



Part Number
1061/OPAQUE - 12 Volt, Blister single
1061/24OPAQUE - 24 Volt, Blister single

Function Strip lamp
Size 300mm x 25mm x 10mm
Voltage 12 Volt or 24 Volt
LED Qty 61
Cable 10cm cable
Draw @13.8V 0.31A
 @28V 0.17A



Part Number
10121/OPAQUE - 12 Volt, Blister single
10121/24OPAQUE - 24 Volt, Blister single

Function Strip lamp
Size 600mm x 25mm x 10mm
Voltage 12 Volt or 24 Volt
LED Qty 121
Cable 10cm cable
Draw @13.8V 0.58A
 @28V 0.31A

Fitting instructions

Remove bezel at each end and surface mount using two screw points, run wires through hole in mounting surface and refit bezel by clicking into place.

Technical Drawings

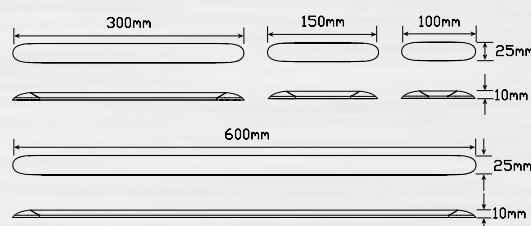

Blister Packaging



Interior Lamps

- High brightness 120° spread
- Low profile
- 3 Year warranty



Part Number

143ILB12 - 12 Volt, Blister single
143ILB24 - 24 Volt, Blister single

Function Large round interior lamp with On/Door/off switch/Black bezel. Output equivalent to a 50 Watt globe

Size 143mm Round x 40mm

Voltage 12 Volt or 24 Volt

LED Qty 120

Cable 40cm cable

Draw @13.8V @28V
0.12A 0.04A

Colour temperature scale



Part Number

143ILC12 - 12 Volt, Blister single
143ILC24 - 24 Volt, Blister single

Function Large round interior lamp with On/Door/off switch/Chrome bezel. Output equivalent to a 50 Watt globe

Size 143mm Round x 40mm

Voltage 12 Volt or 24 Volt

LED Qty 120

Cable 40cm cable

Draw @13.8V @28V
0.12A 0.04A

Colour temperature scale



Fitting instructions

Remove bezel and surface mount using three screw points, run wires through hole in mounting surface and refit bezel by clicking into place.

Technical Drawings

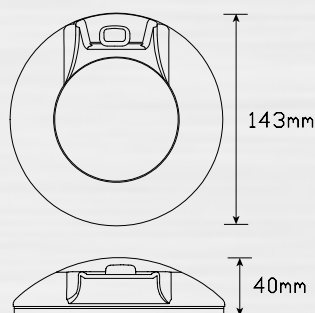

Blister Packaging



Interior Lamps

- High brightness 120° spread
- Low profile
- 3 Year warranty



Part Number
143ILW12 - 12 Volt, Blister single
143ILW24 - 24 Volt, Blister single

Function Large round interior lamp with On/Door/off switch/ White bezel. Output equivalent to a 50 Watt globe

Size 143mm Round x 40mm

Voltage 12 Volt or 24 Volt

LED Qty 120

Cable 40cm cable

Draw @13.8V @28V
 0.12A 0.04A

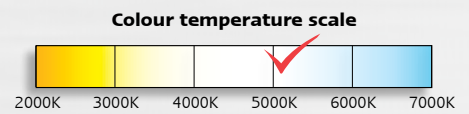

Part Number
143ILG12 - 12 Volt, Blister single
143ILG24 - 24 Volt, Blister single

Function Large round interior lamp with On/Door/off switch/Gold bezel. Output equivalent to a 50 Watt globe

Size 143mm Round x 40mm

Voltage 12 Volt or 24 Volt

LED Qty 120

Cable 40cm cable

Draw @13.8V @28V
 0.12A 0.04A

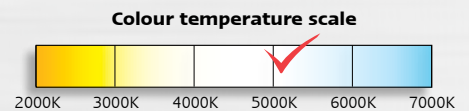

Fitting instructions

Remove bezel and surface mount using three screw points, run wires through hole in mounting surface and refit bezel by clicking into place.

Technical Drawings

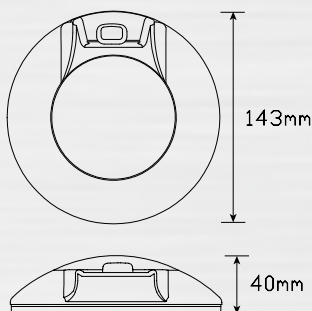

Blister Packaging



Exterior Lamps

- High brightness 70° spread
- Low profile
- 3 Year warranty



Part Number
7524W - 12 Volt, Blister single
7530W - 24 Volt, Blister single

Function Courtesy lamp clear lens/
White bezel
Size 75mm Round x 17mm
Voltage 12 Volt or 24 Volt
LED Qty 12V = 24, 24V = 30
Cable 40cm cable
Draw
@13.8V 0.24A
@28V 0.13A

Colour temperature scale

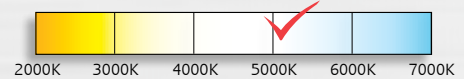

Part Number
7524C - 12 Volt, Blister single
7530C - 24 Volt, Blister single

Function Courtesy lamp clear lens/
Chrome bezel
Size 75mm Round x 17mm
Voltage 12 Volt or 24 Volt
LED Qty 12V = 24, 24V = 30
Cable 40cm cable
Draw
@13.8V 0.24A
@28V 0.13A

Colour temperature scale

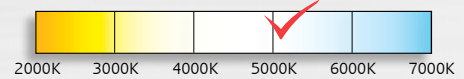

Part Number
7524/OPAQUE - 12 Volt, Blister single
7530/OPAQUE - 24 Volt, Blister single

Function Courtesy lamp opaque lens/
Chrome bezel
Size 75mm Round x 17mm
Voltage 12 Volt or 24 Volt
LED Qty 12V = 24, 24V = 30
Cable 40cm cable
Draw
@13.8V 0.12A
@28V 0.04A

Colour temperature scale



Fitting instructions

Remove bezel and surface mount using three screw points, run wires through hole in mounting surface and refit bezel by clicking into place.

Accessories

75C - Chrome Bezel
 75G - Gold Bezel
 75W - White Bezel

Technical Drawings

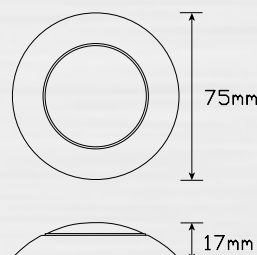

Blister Packaging



Exterior Lamps

- High brightness 70° spread
- Low profile
- 3 Year warranty



Part Number
7524G - 12 Volt, Blister single
7530G - 24 Volt, Blister single

Function Courtesy lamp clear lens/Gold bezel
Size 75mm Round x 17mm
Voltage 12 Volt or 24 Volt
LED Qty 12V = 24, 24V = 30
Cable 40cm cable
Draw
 @13.8V 0.24A
 @28V 0.13A

Colour temperature scale

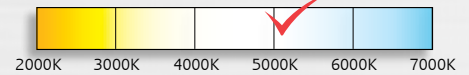

Part Number
7524WR - 12 Volt, Blister single

Function Red & white courtesy lamp/Red bezel
Size 75mm Round x 17mm
Voltage 12 Volt
LED Qty 24
Cable 40cm cable
Draw **Red** **White**
 @13.8V 0.15A 0.24A

Colour temperature scale

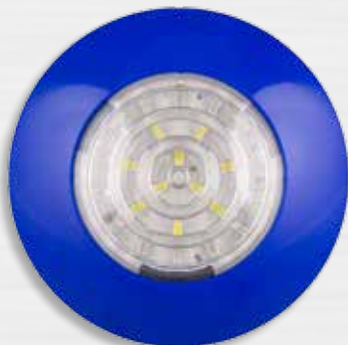

Part Number
7524WB - 12 Volt, Blister single

Function Blue & white courtesy lamp/Blue Bezel
Size 75mm Round x 17mm
Voltage 12 Volt
LED Qty 24
Cable 40cm cable
Draw **Blue** **White**
 @13.8V 0.20A 0.24A

Colour temperature scale

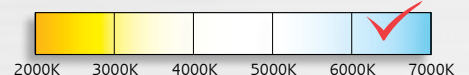

Fitting instructions

Remove bezel and surface mount using three screw points, run wires through hole in mounting surface and refit bezel by clicking into place.

Accessories

- 75C - Chrome Bezel
- 75G - Gold Bezel
- 75W - White Bezel

Technical Drawings

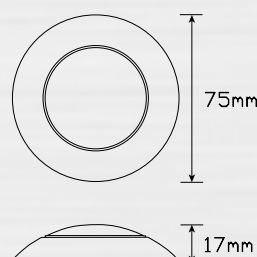

Blister Packaging



Exterior Lamps

- High brightness 120° spread
- Low profile
- 3 Year warranty



Part Number

143120B12 - 12 Volt, Blister single
143120B24 - 24 Volt, Blister single

Function Large round interior/exterior lamp/black bezel. Output equivalent to a 50 Watt globe

Size 143mm Round x 40mm

Voltage 12 Volt or 24 Volt

LED Qty 120

Cable 40cm cable

Draw @13.8V @28V
 0.12A 0.04A

Colour temperature scale

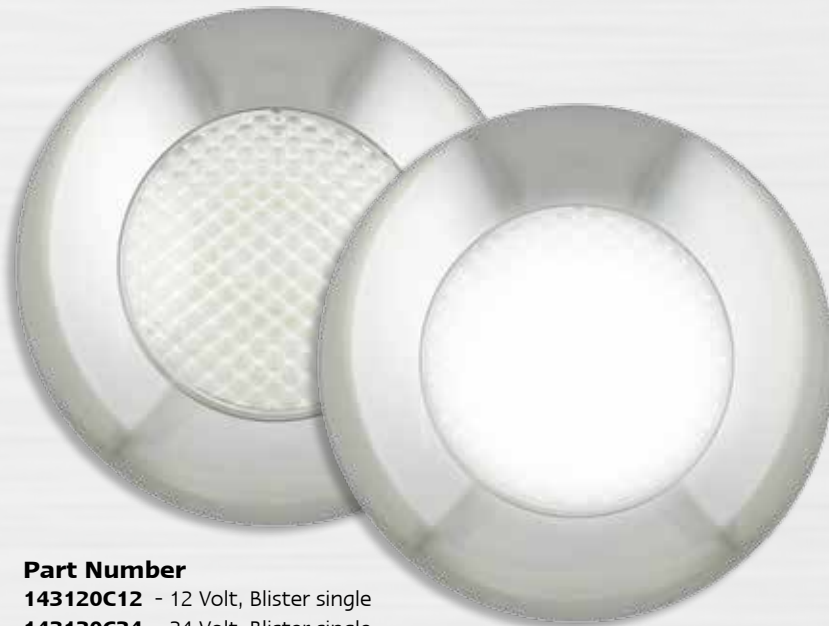

Part Number

143120C12 - 12 Volt, Blister single
143120C24 - 24 Volt, Blister single

Function Large round interior/exterior lamp/chrome bezel. Output equivalent to a 50 Watt globe

Size 143mm Round x 40mm

Voltage 12 Volt or 24 Volt

LED Qty 120

Cable 40cm cable

Draw @13.8V @28V
 0.12A 0.04A

Colour temperature scale



Fitting instructions

Remove bezel and surface mount using three screw points, run wires through hole in mounting surface and refit bezel by clicking into place.

Technical Drawings

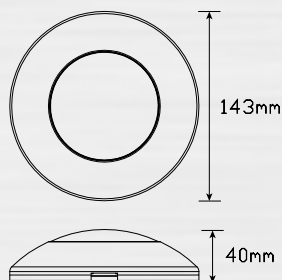

Blister Packaging



Exterior Lamps

- High brightness 120° spread
- Low profile
- 3 Year warranty

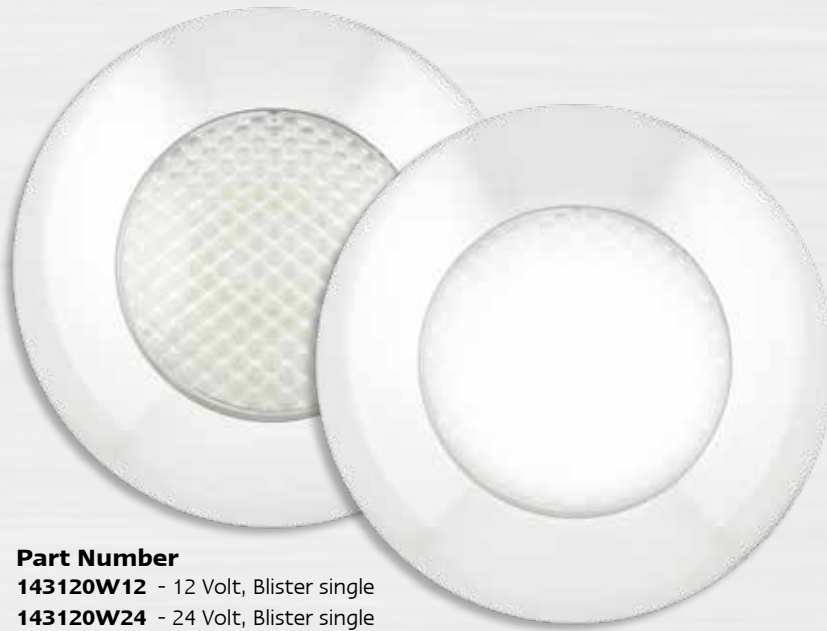

Part Number

143120W12 - 12 Volt, Blister single

143120W24 - 24 Volt, Blister single

Function	Large round interior/exterior lamp/white bezel. Output equivalent to a 50 Watt globe
Size	143mm Round x 40mm
Voltage	12 Volt or 24 Volt
LED Qty	120
Cable	40cm cable
Draw	@13.8V @28V 0.12A 0.04A

Colour temperature scale

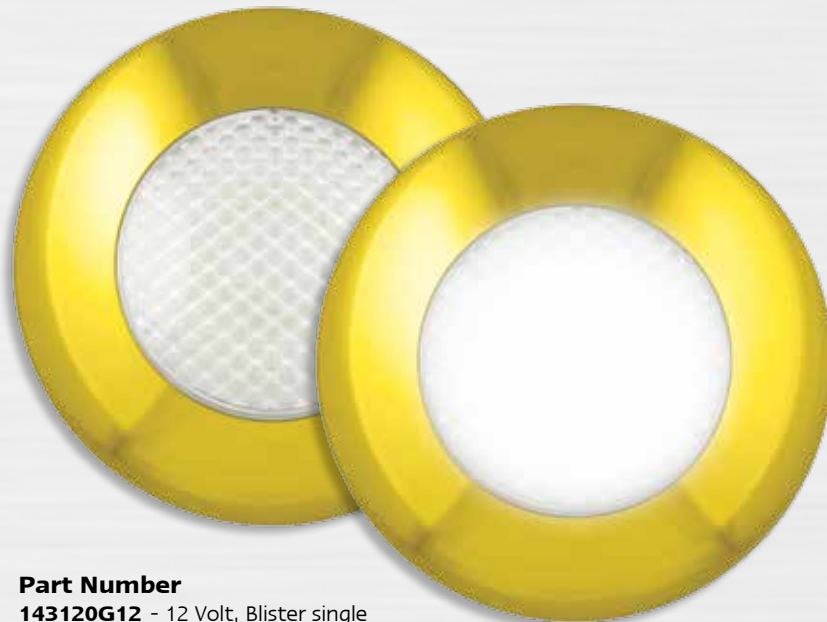
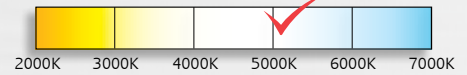

Part Number

143120G12 - 12 Volt, Blister single

143120G24 - 24 Volt, Blister single

Function	Large round interior/exterior lamp/gold bezel. Output equivalent to a 50 Watt globe
Size	143mm Round 40mm
Voltage	12 Volt or 24 Volt
LED Qty	120
Cable	40cm cable
Draw	@13.8V @28V 0.12A 0.04A

Colour temperature scale

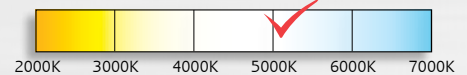

Fitting instructions

Remove bezel and surface mount using three screw points, run wires through hole in mounting surface and refit bezel by clicking into place.

Technical Drawings

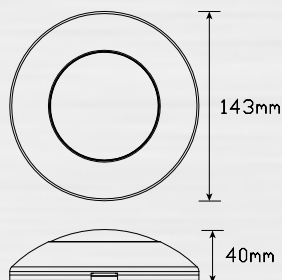

Blister Packaging



Exterior Lamps

- Caravan side lamps 120° spread
- Recessed exterior lamp
- 3 Year warranty



Part Number
186WW - 12 Volt, Blister single

Function Caravan door/side lamp
Size 186mm x 49mm x 31mm
Voltage 12 Volt
LED Qty 8
Cable 40cm cable
Draw
@13.8V 0.12A
@28V 0.04A

Colour temperature scale

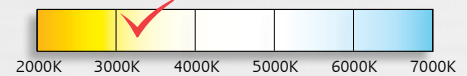

Part Number
380CEL - 12 Volt, Chrome, Blister single

Function Caravan door/side lamp
Size 430mm x 35mm x 35mm
Voltage 12 Volt
LED Qty 18
Cable 40cm cable
Draw
@13.8V 0.14A



Part Number
380WEL - 12 Volt, white, Blister single

Colour temperature scale

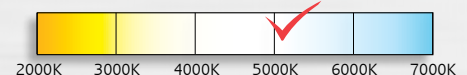

Fitting instructions

186 Series - Remove screw caps by pushing from opposite side with screws supplied. Fit onto flat surface and refit screw caps.

5100 Series - Recessed mount with cut out 130mm x 87mm, fix to flat surface with screws.

380 Series - Remove screw caps by pushing from opposite side with screws supplied. Fit onto flat surface and refit screw caps.

Technical Drawings

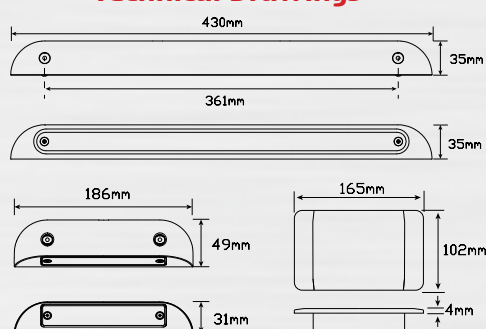

Blister Packaging



Coloured Lamps

- Low profile design
- Shock, dust & water proof
- 5 Year warranty



Part Number
35RM - Multivolt 12-24V
Blister single



Part Number
35AM - Multivolt 12-24V
Blister single



Part Number
35YM - Multivolt 12-24V
Blister single



Part Number
35BM - Multivolt 12-24V
Blister single



Part Number
35GM - Multivolt 12-24V
Blister single



Part Number
35PM - Multivolt 12-24V
Blister single



Part Number
35WM - Multivolt 12-24V
Blister single



Part Number
35WM - Multivolt 12-24V
Blister single

Function	Courtesy lamp
Size	58mm x 35mm x 21mm
Voltage	Multivolt 12-24V
LED Qty	4
Cable	40cm cable

	Draw @13.8V	@28V	Illuminance
Red	0.58A	0.31A	@1m - 10.4lx
Amber	0.10A	0.07A	@1m - 7.5lx
Yellow	0.05A	0.04A	@1m - 7.5lx
Blue	0.04A	0.02A	@1m - 1.3lx
Green	0.04A	0.02A	@1m - 0.6lx
Purple	0.05A	0.04A	@1m - 1.3lx
White	0.05A	0.04A	@1m - 14.7lx

Fitting instructions

Surface mount bracket onto flat surface horizontally to the ground with screws provided, run wires through back and clip lens into place.

Technical Drawings

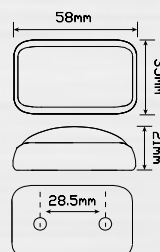

Blister Packaging



Coloured Lamps

- Steel housing
- Shock, dust & water proof
- 5 Year warranty



Part Number
6505RM - Multivolt 12-24V
Blister single



Part Number
6505OM - Multivolt 12-24V
Blister single



Part Number
6505YM - Multivolt 12-24V
Blister single



Part Number
6505BM - Multivolt 12-24V
Blister single



Part Number
6505GM - Multivolt 12-24V
Blister single



Part Number
6505PM - Multivolt 12-24V
Blister single



Part Number
6505WM - Multivolt 12-24V
Blister single



Part Number
6505IM - Multivolt 12-24V
Blister single

Function	Courtesy step lamp
Size	65mm x 30mm x 24mm
Voltage	Multivolt 12-24V
LED Qty	5
Cable	30cm cable

	Draw	@13.8V	@28V	Illuminance
Red	0.03A	0.04A	@1m - 1.10lx	
Amber	0.03A	0.04A	@1m - 3.52lx	
Yellow	0.03A	0.04A	@1m - 4.8lx	
Blue	0.03A	0.04A	@1m - 1.37lx	
Green	0.03A	0.04A	@1m - 1.77lx	
Purple	0.03A	0.04A	@1m - 1.00lx	
White	0.03A	0.04A	@1m - 4.46lx	
Ivory	0.03A	0.04A	@1m - 2.6lx	

Fitting instructions

Surface mount using screws supplied attach and run wires at back.

Technical Drawings

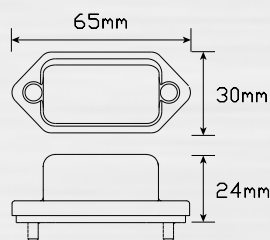

Blister Packaging



Coloured Lamps

- Low profile design
- High brightness SMD LEDs
- 3 Year warranty



Part Number
68R - 12 Volt, Blister single



Part Number
68O - 12 Volt, Blister single



Part Number
68Y - 12 Volt, Blister single



Part Number
68B - 12 Volt, Blister single



Part Number
68G - 12 Volt, Blister single



Part Number
68P - 12 Volt, Blister single



Part Number
68W - 12 Volt, Blister single



Part Number
68I - 12 Volt, Blister single

Function	Strip courtesy lamp
Size	100mm x 25mm x 10mm
Voltage	12 Volt
LED Qty	4
Cable	10cm cable

Draw	@13.8V	illuminance
Red	0.31A	@1m - 3lx
Amber	0.11A	@1m - 10lx
Yellow	0.17A	@1m - 13lx
Blue	0.58A	@1m - 3lx
Green	0.11A	@1m - 11lx
Purple	0.05A	@1m - 6lx
Clear	0.16A	@1m - 16lx
Ivory	0.10A	@1m - 10lx

Fitting instructions

Remove bezel at each end and surface mount using two screw points, run wires through hole in mounting surface and refit bezel by clicking into place.

Technical Drawings

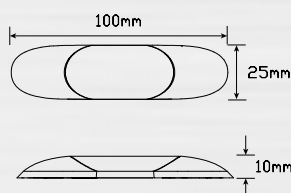

Blister Packaging



Coloured Lamps

- Low profile design
- Only 15mm in width
- 5 Year warranty



Part Number
305R12 - 12 Volt, Blister single



Part Number
305A12 - 12 Volt, Blister single



Part Number
305B12 - 12 Volt, Blister single



Part Number
305G12 - 12 Volt, Blister single



Part Number
305W12 - 12 Volt, Blister single

Function	Coloured Courtesy Lamp
Size	305mm x 15mm x 7mm
Voltage	12 Volt
LED Qty	15
Cable	10cm cable
Draw @13.8V	0.01A

Fitting instructions

Fit to flat surface using two screw points at each end, run wires through hole in fitting surface.

Technical Drawings

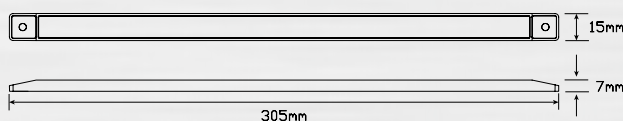

Blister Packaging



Coloured Lamps

- Low profile design
- Shock, dust & water proof
- 5 Year warranty



Part Number
75CLR - 12 Volt, Blister single



Part Number
75CLO - 12 Volt, Blister single



Part Number
75CLY - 12 Volt, Blister single

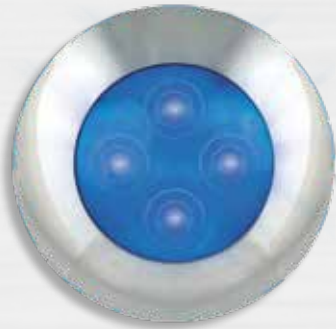

Part Number
75CLB - 12 Volt, Blister single



Part Number
75CLG - 12 Volt, Blister single



Part Number
75CLP - 12 Volt, Blister single



Part Number
75CLI - 12 Volt, Blister single



Part Number
75CLI - 12 Volt, Blister single

Function	Courtesy lamp
Size	75mm Round x 17mm
Voltage	12 Volt
LED Qty	4
Cable	40cm cable

Draw	@13.8V	@28V	Illuminance
Red	0.58A	0.31A	@1m - 10.4lx
Amber	0.10A	0.07A	@1m - 7.5lx
Yellow	0.05A	0.04A	@1m - 7.5lx
Blue	0.04A	0.02A	@1m - 1.3lx
Green	0.04A	0.02A	@1m - 0.6lx
Purple	0.05A	0.04A	@1m - 1.3lx
White	0.05A	0.04A	@1m - 14.7lx

Fitting instructions

Remove bezel and surface mount using three screw points, run wires through hole in mounting surface and refit bezel by clicking into place.

Technical Drawings

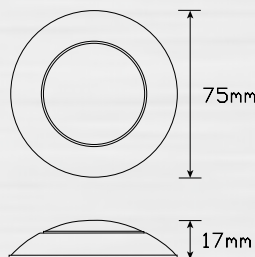

Blister Packaging



Yellow Light Lamps

- Insects can't see in the yellow light
- Perfect for caravan/camping and 4x4
- 3 Year warranty



Insects and Humans see light differently. Light sources which radiate ultraviolet and blue light are more attractive to flying insects. Yellow light or incandescent yellow are difficult for insects to see therefore do not attract insects to the light source. Ideal for caravan and camping.



Part Number

7524YC - 12 Volt, 75mm x 17mm, Bulk poly bag

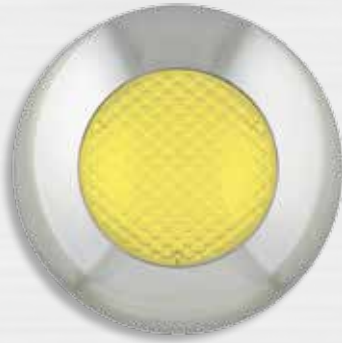

Part Number

143120YC12 - 12 Volt, 143mm x 40mm, Bulk poly bag



Part Number

7451YBM - 12 Volt, 149mm x 115mm x 41mm, Bulk poly bag



Part Number

1061/12YELLOW - 12 Volt, 300mm x 25mm x 10mm, Bulk poly bag



Part Number

380YCEL - 12 Volt, 430mm x 35mm x 35mm, Bulk poly bag

Fitting instructions

Please refer to appropriate page for detailed description of each product

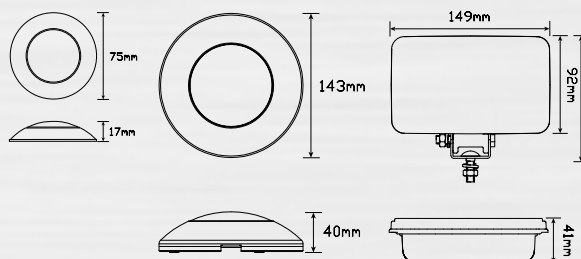

Technical Drawings

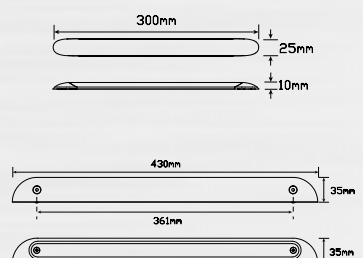

Reflex reflectors

- High quality 3m tape
- Premium quality products
- 5 Year warranty



Part Number
9020R - Blister twin pack
9020RB - Bulk Boxed of 100



Part Number
9020A - Blister twin pack
9020AB - Bulk Boxed of 100



Part Number
9020W - Blister twin pack
9020WB - Bulk Boxed of 100

Function	Size	Function	Category	CRN
Reflex reflector	90mm x 20mm x 6mm			
Approvals				
ECE	Red	02 1a	TBA	
ECE	Amber	02 1a	TBA	
ECE	White	02 1a	TBA	



Part Number
7030R - Blister twin pack
7030RB - Bulk Boxed of 100



Part Number
7030A - Blister twin pack
7030AB - Bulk Boxed of 100



Part Number
7030W - Blister twin pack
7030WB - Bulk Boxed of 100

Function	Size	Function	Category	CRN
Reflex reflector	70mm x 30mm x 6mm			
Approvals				
ADR	Red	47/00	38102	
ADR	Amber	47/00	38101	
ADR	White	47/00	38103	



Part Number
9444RB - Box pack of 100



Part Number
9444AB - Box pack of 100



Part Number
9444WB - Box pack of 100

Function	Size	Function	Category	CRN
Reflex reflector	94mm x 44mm x 8mm			
Approvals				
ECE	Red	02 1a	1015	
ECE	Amber	02 1a	1015	
ECE	White	02 1a	1015	

Fitting instructions

Remove tape backing and place onto flat surface, apply firm hand pressure to ensure adhesion. Please refer to ADR 13/00 for mounting instructions.

Technical Drawings

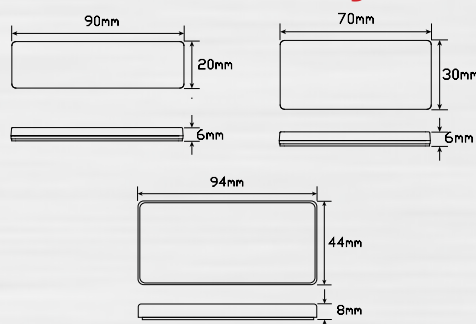

Blister Packaging



Reflex reflectors

- Screw type fitting design
- Premium quality products
- 5 Year warranty



Part Number
7035R - Blister twin pack
7035RB - Bulk Boxed of 100



Part Number
7035A - Blister twin pack
7035AB - Bulk Boxed of 100

Function Reflex reflector
Size 93mm x 35mm x 7mm

Approvals	Function	Category	CRN
ADR	Red	47/00	38102
ADR	Amber	47/00	38101
ADR	White	47/00	38103

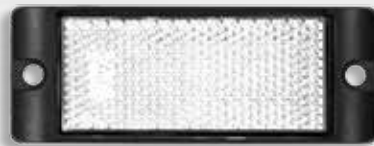

Part Number
7035W - Blister twin pack
7035WB - Bulk Boxed of 100



Part Number
9344RB - Box pack of 100



Part Number
9344AB - Box pack of 100

Function Reflex reflector
Size 94mm x 44mm x 8mm

Approvals	Function	Category	CRN
ECE	Red	02 1a	1015
ECE	Amber	02 1a	1015
ECE	White	02 1a	1015



Part Number
9344WB - Box pack of 100

Fitting instructions

Fit onto flat surface using screw points in bracket. Please refer to ADR 13/00 for mounting instructions.

Technical Drawings

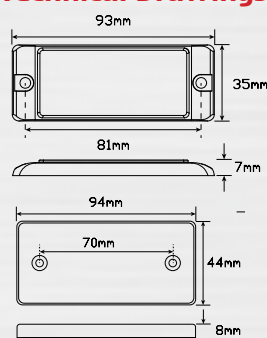

Blister Packaging



- Fast flashing indicator solution
- Picks up LED failure
- 2 Year warranty



THE ADR SOLUTION TO FAST FLASHING INDICATORS

Not compatible if the vehicle indicator system is controlled by a body control module.



I LS Microprocessor Unit

Part Number

ILS3P12 - 12 Volt, Bulk Boxed



I LS Relay



I LS Relay

The i-LS Microprocessor prevents unreliable failure signals being generated from indicator lamps, which can be caused by the extremely low current draws used by LED lamps when installed on traditional bulb lighting systems.

Our i-LS Relay has been designed to be used in conjunction with our i-LS Microprocessor, allowing the reliable detection of an LED indicator failure. The system alerts the driver when an indicator has failed by increasing the flash rate, or terminating an indicator light on the dashboard.

- Fixes fast indicator flashing
- Will pick up LED failure
- Suits 12 volt only
- Maximum load 140 Watts
- ILS Smart relay IP67 rated
- Operating temperature -40 to +80

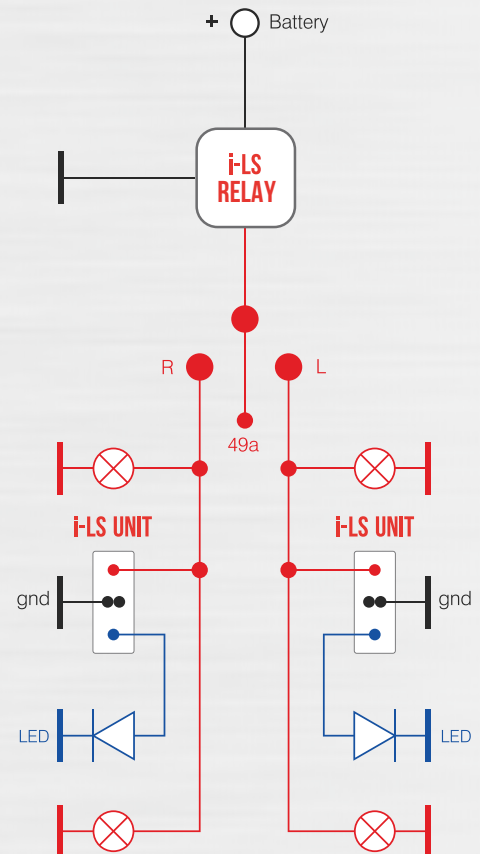

- Draws same current as a 21 watt globe
- Shock, dust & water proof
- 5 Year warranty



DUMMY LOAD RESISTORS



Part Number

LR12/2 - 12 Volt, Blister twin pack
50 Watt 6Ω ohms



Part Number

LR24/2 - 24 Volt, Blister twin pack
50 Watt 24Ω ohms

Must be mounted on metal surface, the resistor can reach temperatures of up to 170° Celsius You may require up to 1 resistor per function on each side.

Dummy load resistors designed to draw the same current as a 21 watt globe. They can be used on vehicles that have electronic components that are not LED compatible.

The Resistor should ALWAYS be wired between the input wires of the lamp, NOT the chassis of the vehicle or trailer! If fitted to the Chassis, a bad earth connection is possible, and can result in problems with the lighting system of the vehicle!

Indicator Circuit:

If fitting to the indicator circuit, fit one lead of the resistor to the positive supply side (Yellow wire) and the other lead of the resistor to the negative supply or ground input wire (White).

Brake Circuit:

If fitting to the brake circuit, fit one lead of the resistor to the positive supply side (Red Wire) and the other lead of the resistor to the negative supply or ground input wire (White)

Correct Fitting:

To fit the resistor, use the crimp terminals supplied. Cut the loom and re-connect the cut wires within the supplied crimp terminal with one side of the resistor crimped into that terminal. Repeat the process for the remaining wire and the other end of the resistor.
Use the 2 screw down points on the resistor to secure it to a metal chassis.

Important Notice:

Must be mounted on metal surfaces, the resistor can reach up to 170 deg C, do not mount the resistor on any surface that can be melted by the heat of the resistor, this includes plastics, hoses or painted surfaces.

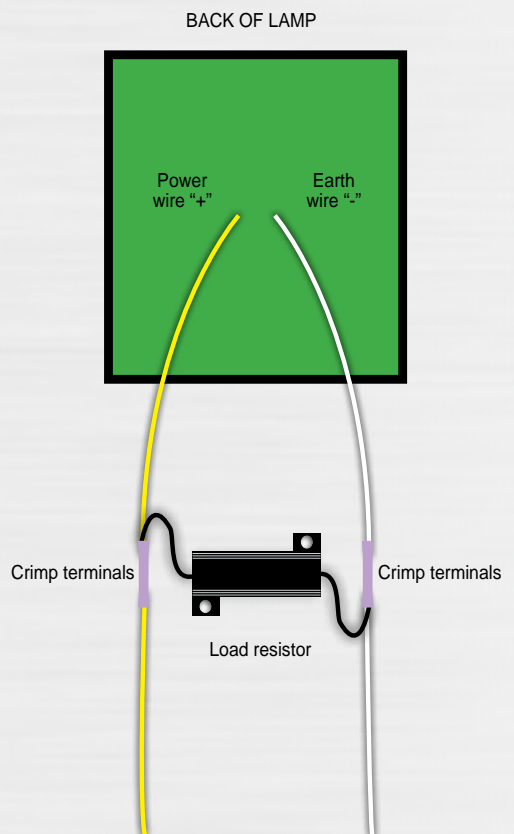

- Detects Multiplexed system BSI
- Dual Voltage 12-24V compatibility
- 2 Year warranty

ELECTRONIC CANBUS UNIVERSAL WIRING KIT

For towbars with electronic fault detection. Detects light system with double function
(Multiplexed system BSI)



Part Number

CANBUSKIT - 12-24 Volt systems, Boxed

This wiring kit can be installed in the majority of passenger or commercial vehicles, without any interference with electrical system, and compatible with:

- BSI systems with multiplexed cable (Lights with mixed voltages) - 12 or 24 volts
- CAN BUS data system - Check-Control (Sensor failure light SFL)
- Bulbs or/and lamps with leds diodes

The module is protected against short circuits and prevents any overload or failure of the electrical system of vehicle by feeding the trailer lamps directly from the vehicle battery, independently of rest of the vehicle electrical system.

- The module detects when the trailer is connected
- Lights system with double function by only one cable (Multiplexed system BSI)
- Easy to fit with fast connections saving time of assembly.
- Low power consumption in standby mode.

The universal wiring kit must be installed by professional automotive electricians. This product has a 2 year warranty subject to the kit being fitted in accordance with the manufacturers fitting instructions. LED Autolamps will in all circumstances only offer to replace a faulty product.

Kit contains;

- 1 x Module 1 x Red/white battery cable 1 x trailer plug cable 1 x cable to vehicle 1 x Kit bag



ADJUSTABLE FLASH UNIT



The Safety Flash Unit is designed for two or more rear facing amber lights to flash left and right with adjustable speed settings. Perfect for breakdown or stationary delivery vehicles.

Output - 2 Channels, 1 Amp which equates to 4 LED Amber lamps per channel.

Installation options:

- 1 - Use double sided tape to attach to dashboard, supplied with unit.
- 2 - Open the case from the right hand side using a flat blade screw driver, and use the 2 screw positions to screw the base to the dashboard. Then replace the lid of the case.

Part Number

SFU1B - 12 or 24 Volt DC capable, Bulk poly bag

AC - DC CONVERTER

The ACDC1 solves a problem in the transport industry where some trucks have an output in AC only. AC voltage can damage some brands of LED lights!

By simply connecting this unit to the output of the AC down converter, the ACDC1 will convert the AC signal to a rectified and regulated 12 volt DC output and supply the LED lights with an acceptable voltage source that will keep them running for years to come.



Installation:

Fit box to inside of cabin; 2 brown wires for AC input, 1 red wire for 12 volt positive output and 1 white wire for the output negative or ground connection. Protection with a 2 Amp fast blow M205 fuse on the input (AC) internal to the ACDC1 box.

Part Number

ACDC1 - 12 - 18 Volt DC out, Bulk poly bag

AC input: 12-18volts AC

DC Output: Regulated 12 volt DC out

Output Current: Maximum of 2 Amps DC

LIFETIME WARRANTY

As of September 2013 over 670,000 units of the 150 series have been sold with a return rate of a minimal 0.2%. This lamp has been outperforming in the autolamps market for 7 years and is tried and trusted by major OEMs and retailers Australia wide. LED Autolamps' have 100% confidence in this product which is why all 150 Series models include a lifetime warranty promise on their electrical components.

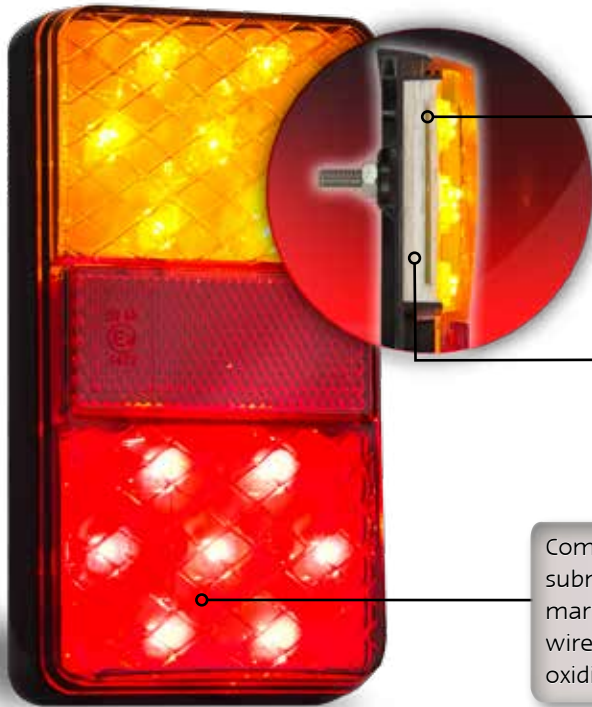

FR4 PCB Materials in the circuit boards provide mechanical strength, optimum electrical insulation and have fire retardant qualities, giving you a product that is stronger right from the very core.

PCB fully encased in a specially formulated polyester resin that resists tearing, abrasion and heat to protect the electrical components from the elements.

Completely water proof unit, rated to IP6 submersible to 1 metre, also fitted with marine industry standard tinned copper wire that resists corrosion and won't oxidise.

Rob Trubuil from Telwater, manufacturers of Quintrex, Stacer and Savage Trailers states...

"We have been using the LED Autolamps 150 Series for the past two years because they surpass their opposition in quality, performance & service."

Tony Ottobre owner of LED Autolamps and manufacturers of the 150 Series states... "These lights are built to superior industry standards and use only top quality LEDs and associated components. They are the reliable, affordable solution for trailer owners and manufacturers who are serious about performance and include a manufacturer's warranty of 100,000 hours. The average trailer use is 1000 hours per year which equates to 100 years of use, all covered by LED Autolamps 100 year warranty promise."

Compatible with LED Autolamps water proof cable systems



BOAT TRAILERS



BOX/TANDEM

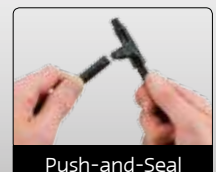

Push-and-Seal



autolamps

We design, manufacture and guarantee it.

Ph: 03 9466 7075 - FAX: 03 9466 8112 - www.ledautolamps.com

HOW GOOD IS THIS...

Benchmark 150 series from LED Autolamps. The only rear combination lamp in Australia with a lifetime warranty. We guarantee it for your lifetime or 100 years whichever comes first

First introduced in Australia December 2006 with a lifetime warranty and as of September 2013 LED Autolamps have sold over 670,000 units with a minimal 0.2% return rate. This product is built to the highest quality standards and comes with a lifetime guarantee. An Australian first for rear combination lamps, making the 150 Series lamps the most reliable automotive LED product in Australia.

Manufactured using high quality LEDs and associated components to drive the LEDs within their electrical parameters and using FR4 PCB material which is known to retain high mechanical values and electrical insulation qualities. The PCB is fully encased in a specially formulated polyester resin designed for durability and resistance to tearing, abrasion and heat. This procedure to the PCB design completely protects the electrical components from the elements. The lifespan of the electrical components have a manufacturer's warranty of 100,000 hours. The average trailer use is 1000 hours per year this equates to 100 years of use.

The 150 series is completely water proof and rated to IP67 submersible to 1 meter. The cabling system has tinned copper wire, used in the marine industry for its resistance to corrosion and doesn't oxidise.

LED Autolamps is an Australian company with 31 employees in Australia and 15 in Europe with dedicated engineers, Research and Development department, a manufacturing and assembly plant in Australia and Taiwan.



autolamps

We design, manufacture and guarantee it.

Ph: 03 9466 7075 - FAX: 03 9466 8112 - www.ledautolamps.com

We design, manufacture and guarantee it.

All enquiries P: (03) 9466 7075 E: led@ledtech.com.au

www.ledautolamps.com

CAT6 printed June 2014



autolamps

NEW PRODUCT

**Front Indicator/Marker
Lamp with Accessory Daytime
Running Function***



Front Indicator and marker lamp with daytime running accessory function when used in conjunction with Part Number: DRLHOTDOG

- Retro fit to existing 4x4 bullbar
- ECE Australian Road Approved
- IP67 Water/Dust proof
- 5 Year Warranty

List Price
\$95.29+gst



Part No. 175AWTB2

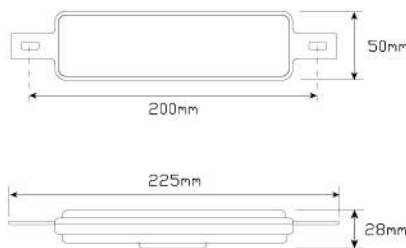

*DRLHOTDOG

Specifications		
Part No	175AWTB2	DRLHOTDOG
List Price	\$95.29	\$15.78
Package	Blister twin pack	Box
Function	Front Indicator/Marker/Daytime running lamp use Part No. *DRLHOTDOG	Enables 175AWTB to be used as Daytime Running lamp
LED Qty	39	N/A
Voltage	12 Volt	12/24 Volt
Cable	400mm	19cm each side
Lens	Hardened Acrylic	N/A
Base	ABS	N/A

All enquiries P: (03) 9466 7075, E: led@ledtech.com.au, www.ledautolamps.com

DISCLAIMER - LED Technologies Pty. Ltd. have made every effort to ensure that the information is correct and accurate at the time of printing. Print Date March 2015



led
autolamps

NEW PRODUCT

**Front Indicator/Marker
Lamp with Accessory Daytime
Running Function***



Front Indicator and marker lamp with daytime running accessory function when used in conjunction with Part Number: DRLHOTDOG

- Retro fit to existing 4x4 bullbar
- ECE Australian Road Approved
- IP67 Water/Dust proof
- 5 Year Warranty

List Price
\$95.29+gst



Part No. 175AWTB2

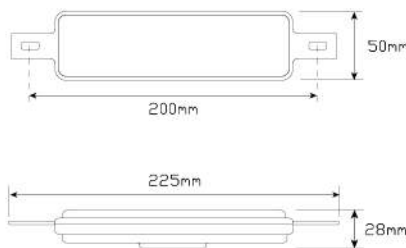

*DRLHOTDOG

Specifications

Part No	175AWTB2	DRLHOTDOG
List Price	\$95.29	\$15.78
Package	Blister twin pack	Box
Function	Front Indicator/Marker/Daytime running lamp use Part No. *DRLHOTDOG	Enables 175AWTB to be used as Daytime Running lamp
LED Qty	39	N/A
Voltage	12 Volt	12/24 Volt
Cable	400mm	19cm each side
Lens	Hardened Acrylic	N/A
Base	ABS	N/A

All enquiries P: (03) 9466 7075, E: led@ledtech.com.au, www.ledautolamps.com

DISCLAIMER - LED Technologies Pty. Ltd. have made every effort to ensure that the information is correct and accurate at the time of printing. Print Date March 2015



autolamps

JUST ARRIVED

New Design Mini Jumbo



Part No. 420ARRWM

Part No. 420AARRM

Rear Combination lamps for Medium Vehicle, Truck or Trailer

- Fully serviceable with in built Reflectors
- Horizontal or Vertical mounting
- Low profile slimline design



Specifications		
Part No	420AARRM	420ARRWM
List Price	\$95.19	\$105.77
Package	Blister single	Blister single
Function	Stop/Tail/Ind with Reflectors	Stop/Tail/Indicator/Reverse with Reflectors
LED Qty	48	48
Voltage	12-24 Volt	12-24 Volt
Warranty	5 Years	5 Years
Cable	1.2 metre	1.2 metre
Lens	Hardened Acrylic	Hardened Acrylic
Base	ABS	ABS

All enquiries P: (03) 9466 7075, E: led@ledtech.com.au, www.ledautolamps.com

DISCLAIMER - LED Technologies Pty. Ltd. have made every effort to ensure that the information is correct and accurate at the time of printing. Printed February 2015



autolamps

JUST ARRIVED

**A Revolutionary new
Licence Plate Lamp
design that saves
installation time**



Part No. 60BLMB

\$7.90

List Price + gst



- Drill a 10mm hole for the serrated plug.
- Pull the sheathed cable through the hole.
- Remove the protective film from the 3M tape.
- Push the serrated plug into the hole
- Line up the lamp and press firmly.
- The lamp is held securely with the plug serrations and high quality 3M tape.
- We guarantee this product for 5 Years.

- ECE and Australian Road Approved
- 2 Required for compliance
- Non fastner fitting design
- Low Profile Compact Design
- Voltage Range 12-24V

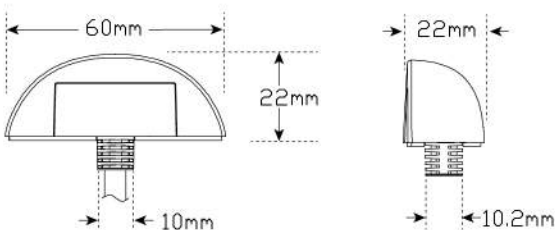

Specifications

Part No	60BLM	60BLMB	60CLM	60CLMB	60WLMB
List Price	\$19.90	\$7.90	\$19.90	\$7.90	\$7.90
Package	Twin Blister	Poly Bag	Twin Blister	Poly Bag	Poly Bag
Function	Licence Plate Lamp	Licence Plate Lamp	Licence Plate Lamp	Licence Plate Lamp	Licence Plate Lamp
LED Qty	4 SMD	4 SMD	4 SMD	4 SMD	4 SMD
Voltage	12-24 Volt	12-24 Volt	12-24 Volt	12-24 Volt	12-24 Volt
Warranty	5 Years	5 Years	5 Years	5 Years	5 Years
Cable	10cm	50cm	10cm	50cm	50cm
Lens	Polycarbonate	Polycarbonate	Polycarbonate	Polycarbonate	Polycarbonate
Base	ABS	ABS	ABS	ABS	ABS

**60BLMB in Bulk now available, Twin blister packs, chrome and white base arriving soon.
Backorder your products today.**



autolamps

NEW PRODUCT

Maxilamp 45 Watt Driving Lamp



List Price
\$490+gst

High powered LED driving lamp
Brilliant road visibility

- 2450 Lumen driving lamp
- Polycarbonate lens cover
- 100% Water proof
- 10-32 Voltage
- 5 Year Warranty



Front active Front park active



Part No. HL198

Specifications

Part No	HL198
List Price	\$490.00
Package	Blister twin pack
Function	9 Inch Driving Lamp
LED Qty	15 x 3 Watt
Voltage	10-32 Volt
Cable	250mm
Lens	Polycarbonate lens cover
Base	Die Cast Alloy

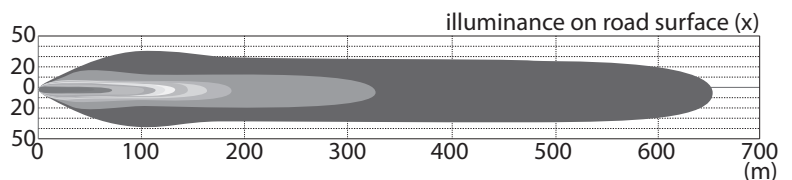
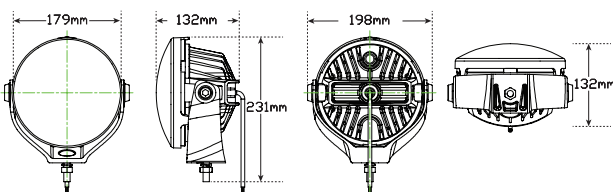

All enquiries P: (03) 9466 7075, E: led@ledtech.com.au, www.ledautolamps.com

DISCLAIMER - LED Technologies Pty. Ltd. have made every effort to ensure that the information is correct and accurate at the time of printing. Print Date March 2015

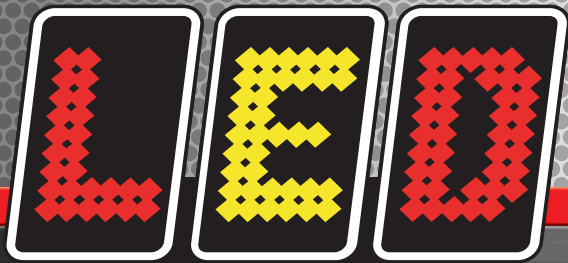

autolamps

NEW PRODUCT

Maxilamp 7 inch LED Headlamp Sealed Beam Conversion Upgrade



List Price
\$590+gst

High powered 7 inch headlamp Sealed beam conversion upgrade

- 940 Lumen low beam
- 1422 Lumen high beam
- H4 Plug standard
- 100% Water dust proof
- 11-32 Volt
- 5 Year Warranty



Part No. HL175



High Beam Active



Low Beam Active



Park Lamp Active

Specifications

Part No	HL175
List Price	\$590.00
Package	Blister twin pack
Function	7 Inch Driving Lamp
LED Qty	1x17W High Beam, 4x3W Low Beam, 2 SMD Park
Voltage	10-32 Volt
Cable	120mm with H4 Plug
Lens	Polycarbonate lens cover
Base	Alloy

Road Legal High Beam HL175

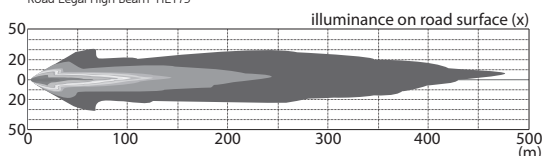

Road Legal Low Beam HL175

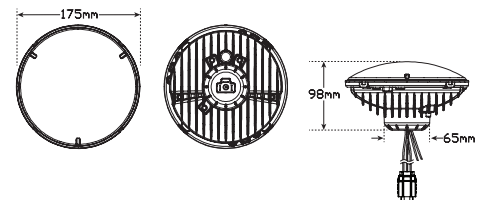
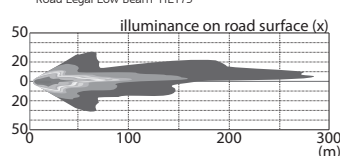

All enquiries P: (03) 9466 7075, E: led@ledtech.com.au, www.ledautolamps.com

DISCLAIMER - LED Technologies Pty. Ltd. have made every effort to ensure that the information is correct and accurate at the time of printing. Print Date March 2015



autolamps

IN STOCK NOW

NEW Low profile Interior Lamps



- 15 High brightness LEDs
- 250 Effective Lumen
- Cool White 6500 Kelvin
- Low profile only 9mm
- 3 Year Warranty

List Price

\$14.90+gst each

7515C Single blister available in June

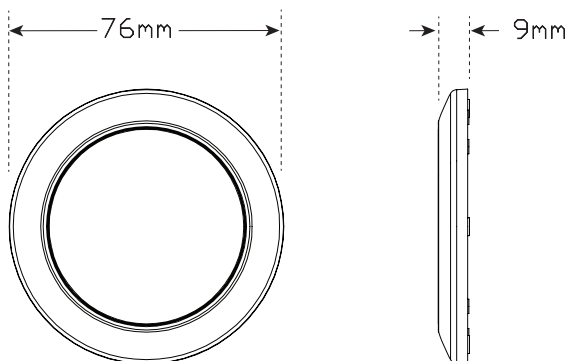

Specifications		
Part No	7515CB	7515C
List Price	\$14.90	\$14.90
Package	Poly Bag	Blister
Function	Interior lamp	Interior lamp
LED Qty	15	15
Voltage	12 Volt	12 Volt
Warranty	3 Years	3 Years
Cable	29cm	29cm
Lens	Polypropylene	Polypropylene
Base	ABS	ABS

All enquiries P: (03) 9466 7075, E: led@ledtech.com.au, www.ledautolamps.com

DISCLAIMER - LED Technologies Pty. Ltd. have made every effort to ensure that the information is correct and accurate at the time of printing. Print Date May 2015



autolamps

IN STOCK NOW

NEW Low profile Interior Lamps



- **15 High brightness LEDs**
- **250 Effective Lumen**
- **Cool White 6500 Kelvin**
- **Low profile only 9mm**
- **3 Year Warranty**

7515C Single blister available in June

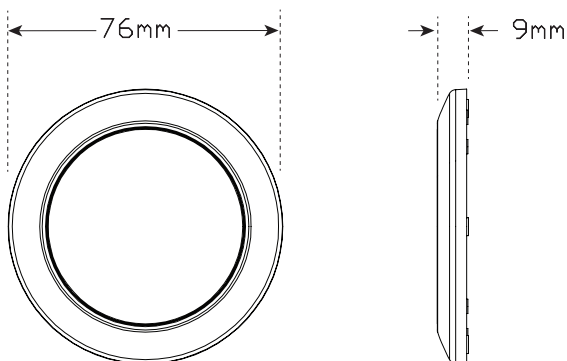

Specifications		
Part No	7515CB	7515C
Package	Poly Bag	Blister
Function	Interior lamp	Interior lamp
LED Qty	15	15
Voltage	12 Volt	12 Volt
Warranty	3 Years	3 Years
Cable	29cm	29cm
Lens	Polypropylene	Polypropylene
Base	ABS	ABS

All enquiries P: (03) 9466 7075, E: led@ledtech.com.au, www.ledautolamps.com

DISCLAIMER - LED Technologies Pty. Ltd. have made every effort to ensure that the information is correct and accurate at the time of printing. Print Date May 2015



autolamps

IN STOCK NOW

**Interior Strip Lamps
with On/Off Switch**



- **Low profile with two lengths and lens types**
- **Concealed easy to use push button**
- **High brightness SMD LEDs**
- **3 Year warranty**

Specifications

Part No	1061/12SW	1061/24SW	1061/12SW OPAQUE	1061/24SW OPAQUE	10121/12SW	10121/24SW	10121/12SW OPAQUE	10121/24SW OPAQUE
List Price	\$66.18	\$66.18	\$66.18	\$66.18	\$121.76	\$121.76	\$121.76	\$121.76
Package	Blister	Blister	Blister	Blister	Blister	Blister	Blister	Blister
Function	Interior Lamp Clear lens	Interior Lamp Clear lens	Interior Lamp Opaque lens	Interior Lamp Opaque lens	Interior Lamp Clear lens	Interior Lamp Clear lens	Interior Lamp Opaque lens	Interior Lamp Opaque lens
LED Qty	61	61	61	61	121	121	121	121
Output	340lm	340lm	250lm	250lm	670lm	670lm	490lm	490lm
Voltage	12 Volt	24 Volt	12 Volt	24 Volt	12 Volt	24 Volt	12 Volt	24 Volt
Warranty	3 Years	3 Years	3 Years	3 Years	3 Years	3 Years	3 Years	3 Years
Cable	100mm	100mm	100mm	100mm	100mm	100mm	100mm	100mm
Lens	Polycarbonate	Polycarbonate	Polycarbonate	Polycarbonate	Polycarbonate	Polycarbonate	Polycarbonate	Polycarbonate
Bezel	ABS	ABS	ABS	ABS	ABS	ABS	ABS	ABS

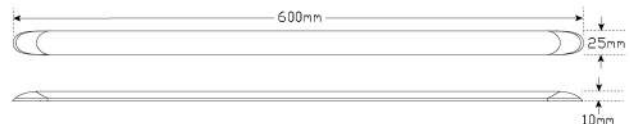
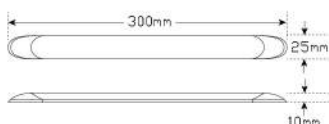

All enquiries P: (03) 9466 7075, E: led@ledtech.com.au, www.ledautolamps.com

DISCLAIMER - LED Technologies Pty. Ltd. have made every effort to ensure that the information is correct and accurate at the time of printing. Print Date February 2015



autolamps

JUST ARRIVED

**Front Indicator/Marker
Lamp with Accessory Daytime
Running Function***



Front Indicator and marker lamp with daytime running accessory function when used in conjunction with Part Number: DRLHOTDOG

- **Retro fit to existing 4x4 bullbar**
- **ECE Australian Road Approved**
- **Fully submersible**
- **5 Year Warranty**

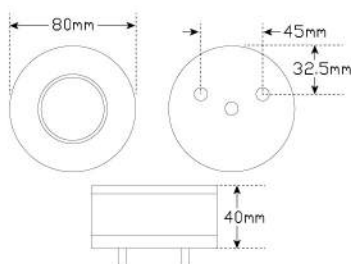

*DRLHOTDOG

Specifications				
Part No	80AW	80AWB	80AW24	DRLHOTDOG
List Price	\$52.83	\$50.72	\$52.83	\$15.78
Package	Blister single	Poly Bag	Blister single	Box
Function	Front Indicator Front Marker Daytime Running use Part No. *DRLHOTDOG	Front Indicator Front Marker Daytime Running use Part No. *DRLHOTDOG	Front Indicator Front Marker Daytime Running use Part No. *DRLHOTDOG	Enables 80AW, 80AWB & 80AW24 to be used as Daytime Running lamp
LED Qty	34	34	34	N/A
Voltage	12 Volt	12 Volt	24 Volt	12/24 Volt
Cable	40cm Sheathed	40cm Sheathed	40cm Sheathed	19cm each side

All enquiries P: (03) 9466 7075, E: led@ledtech.com.au, www.ledautolamps.com

DISCLAIMER - LED Technologies Pty. Ltd. have made every effort to ensure that the information is correct and accurate at the time of printing. Print Date February 2015

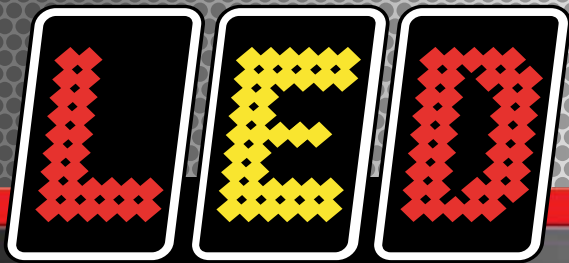

autolamps

IN STOCK NOW

60 Watt Driving Lights



Part No. 1786SBM

7" Round

\$222.24+gst



Part No. 2296SBM

9" Round

\$264.59+gst

- High Powered 6 x 10W Cree LEDs
- SMD LEDs outer for marker function
- 2749 Effective/5400 Raw Lumen
- 100% Water, dust and shock proof



Driving Light Active



Marker Active

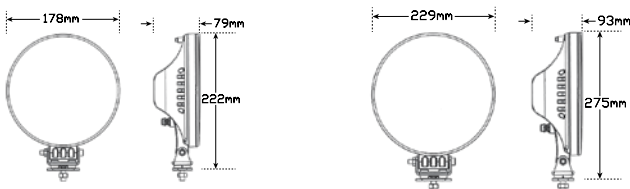
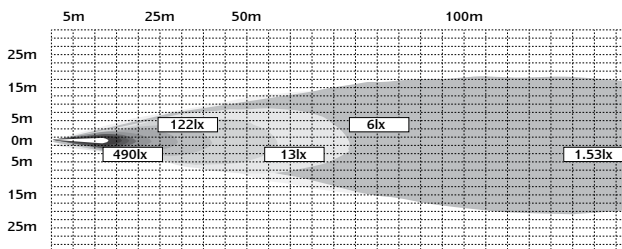

Specifications

Part No	1786SBM	2296SBM
List Price	\$222.24	\$264.59
Package	Box	Box
Function	Driving/spot light	Driving/spot light
Lumen	2749 Effective	2749 Effective
LED Qty	6x10W + 36 SMD	6x10W + 48 SMD
Voltage	Multivolt 10-30V	Multivolt 10-30V
Warranty	2 Years	2 Years
Lens	Polycarbonate	Polycarbonate
Base	Die Cast Alloy	Die Cast Alloy

All enquiries P: (03) 9466 7075, E: led@ledtech.com.au, www.ledautolamps.com

DISCLAIMER - LED Technologies Pty. Ltd. have made every effort to ensure that the information is correct and accurate at the time of printing. Print Date January 2015

We design, manufacture and guarantee it.

All enquiries P: (03) 9466 7075 E: led@ledtech.com.au

www.ledautolamps.com

CAT6 printed June 2014